

*3<sup>rd</sup> International Hybrid Symposium of*  
**Forest Engineering and Technologies**  
**FETEC 2022**

*“Forest Transportation Solutions and IT Applications for Natural Disaster Management”*

**SYMPOSIUM PROCEEDINGS**

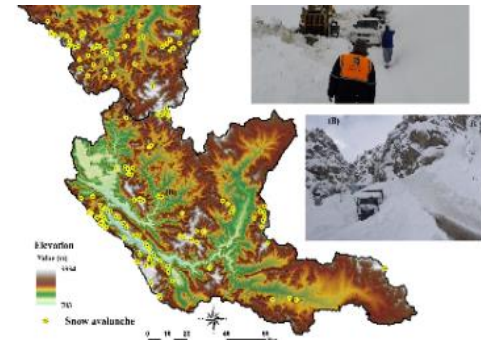
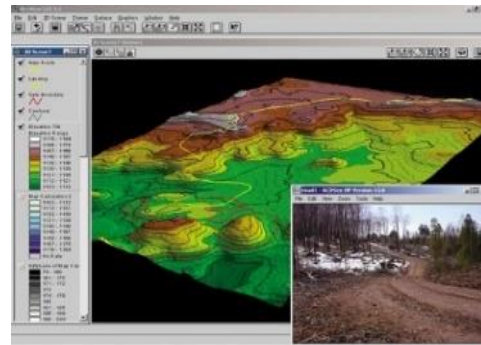

**28-29 November 2022**  
**Baku, Azerbaijan**

**Space Agency of the Republic of Azerbaijan**  
72 Uzeyir Hajibayli str.  
Baku, Azerbaijan, AZ1000

[www.azercosmos.az](http://www.azercosmos.az)  
[info@azercosmos.az](mailto:info@azercosmos.az)  
[www.ormantransportu.org/FETEC2022](http://www.ormantransportu.org/FETEC2022)



## **SYMPOSIUM COMMITTEES**

### **Honorary Committee**

Samaddin Asadov, *Azercosmos, Baku, Azerbaijan*

Bekir Karacabey, *General Director, GDF, Ankara, Turkiye*

Prof.Dr. Woodam Chung, *IUFRO Division 3.0, OSU, Oregon, ABD*

Prof.Dr. Huseyin E. Celik, *FETEC, Istanbul University-C, Istanbul, Turkiye*

### **Organizational Committee**

Dunay Badirkhanov, *Azercosmos, Baku, Azerbaijan*

Prof.Dr.Selcuk Gumus, *KTU, Trabzon, Turkiye*

Prof.Dr.Abdullah E. Akay, *IUFRO Division 3.01, BTU, Bursa, Turkiye*

Prof.Dr.Abdurrahim Aydin, *DU, Duzce, Turkiye*

Ahu Peruzhan Özyakub, *GDF, Ankara, Turkiye*

Ismat Bakhishov, *Azercosmos, Baku, Azerbaijan*

Elman Alaskarov, *Azercosmos, Baku, Azerbaijan*

### **Secretarial**

Assist.Prof.Dr. Remzi Eker, *IKCU, Izmir, Turkiye*

Vugar Bayramov, *Azercosmos, Baku, Azerbaijan*

Yusif Abiyev, *IB, MSE, Baku, Azerbaijan*

## Scientific Committee

- Prof.Dr. H. Hulusi Acar, *IYYU, Istanbul, Turkiye*  
Prof.Dr. Abdullah E. Akay, *BTU, Bursa, Turkiye*  
Prof.Dr. Fuad Hacizade, *IGG, Baku, Azerbaijan*  
Prof.Dr. Kazuhiro Aruga, *UDAI, Japan*  
Prof.Dr. Ayhan Atesoglu, *BU, Bartin, Turkiye*  
Prof.Dr. Abdurrahim Aydin, *DU, Duzce, Turkiye*  
Prof.Dr. Stelian A. Borz, *UniTVb, Braşov, Romania*  
Prof.Dr. Erhan Caliskan, *KTU, Trabzon, Turkiye*  
Prof.Dr. Huseyin E. Celik, *IU-C, Istanbul, Turkiye*  
Prof.Dr. Rza Mahmudov, *IG, Baku, Azerbaijan*  
Prof.Dr. Oguz Coban, *IUAS, Isparta, Turkiye*  
Prof.Dr. Murat Demir, *IU-C, Istanbul, Turkiye*  
Prof.Dr. Vasileios C. Drosos, *DUTH, Greece*  
Prof.Dr. Mehmet Eker, *IUAS, Isparta, Turkiye*  
Prof.Dr. M. Reza Ghaffariyan, *USC, Australia*  
Prof.Dr. Selcuk Gumus, *KTU, Trabzon, Turkiye*  
Prof.Dr. Aytaj Badalova, *NAA, Baku, Azerbaijan*  
Prof.Dr. Temesgen Hailemariam, *OSU, OR, USA*  
Prof.Dr. Han-Sup Han, *NAU, Arizona, USA*  
Prof.Dr. Hajri Haska, *UBT, FFS, Albania*  
Prof.Dr. Ayhan Koc, *IU-C, Istanbul, Turkiye*  
Prof.Dr. Tolga Ozturk, *IU-C, Istanbul, Turkiye*  
Prof.Dr. Igor Potočnik, *UL, Ljubljana, Slovenia*  
Prof.Dr. Ali Rasouli, *MU, Sydney, Australia*  
Prof.Dr. Hideo Sakai, *UT, Tokyo, Japan*  
Prof.Dr. Dzevada Sokolovic, *US, Bosnia&Herzegovina*  
Prof.Dr. Bogdan Strimbu, *OSU, Oregon, USA*  
Prof.Dr. Mohd Nazip Suratman, *UiTM, Malaysia*  
Prof.Dr. Ingrid Teich, *INTA, Argentina*  
Prof.Dr. Metin Tunay, *BU, Bartin, Turkiye*  
Prof.Dr. Osman Yalcin Yilmaz, *IU-C, Istanbul, Turkiye*  
Prof.Dr. Hakan Yener, *IU-C, Istanbul, Turkiye*  
Assoc.Prof.Dr. Rovshan Abbasov, *KU, Azerbaijan*  
Assoc.Prof.Dr. Borys Bakay, *UNFU, Ukraine*  
Assoc.Prof.Dr. Stefano Grigolato, *UNIPD, Italy*  
Assoc.Prof.Dr. Norizah Kamarudin, *UPM, Malaysia*  
Assoc.Prof.Dr. Zaman Mammadov, *ISSA, Azerb.*  
Assoc.Prof.Dr. Robert Keefe, *UI, Idaho, USA*  
Assoc.Prof.Dr. Ekaterina Podolskaia, *MIREA, Russia*  
Assoc.Prof.Dr. Aydin Yahyayev, *WCU, Azerbaijan*  
Assoc.Prof.Dr. Raffaele Spinelli, *IBE, Italy*  
Assoc.Prof.Dr. Ilgar Dadashov, *AMES, Azerbaijan*  
Assoc.Prof.Dr. Oleg Styranivsky, *UNFU, Ukraine*  
Assoc.Prof.Dr. Michael Wing, *OSU, Oregon, USA*  
Assoc.Prof.Dr. Akif Aghbabali, *BSU, Azerbaijan*  
Assist.Prof.Dr. Dalia Abbas, *Washington DC, USA*  
Assist.Prof.Dr. Dzhamal Amishev, *LU, Canada*  
Assoc.Prof.Dr. Rauf Muradov, *RSSC, Azerbaijan*  
Assist.Prof.Dr. Matevz Mihelic, *UL, LJ, Slovenia*  
Assist.Prof.Dr. Anton Poje, *UL, Ljubljana, Slovenia*  
Dr. Kamala Agayeva, *NASA, Azerbaijan*  
Dr. rer. nat. Stephan Hoffmann, *NIBIO, Norway*

## INTRODUCTION

As one of the most important natural resources, forests have vital functions such as improving biodiversity, preserving soil, protecting water, and providing services to society. In order to maintain these functions, forest should be planned and managed by considering social, economic, ecological, and sociocultural factors. In recent years, natural disasters caused by abiotic factors result in serious biological and ecological damages on forest ecosystems while threatening the human life. The most effective natural disasters may include forest fires, winter storms, floods, landslides, and avalanches.

In order to minimize the detrimental effects of natural disasters, advanced information technologies (ITs) such as GIS, RS, ICT, IoT, etc. should be used in planning and implementing of natural disaster management activities. Besides, forest roads, providing important benefits of accessing forest areas, should be designed and constructed considering the natural disasters.

**3<sup>rd</sup> International Symposium of Forest Engineering and Technologies (FETEC 2022):** “*Forest Transportation Solutions and IT Applications for Natural Disaster Management*” was organized on **28-29 November 2022** by **Space Agency of the Republic of Azerbaijan (Azercosmos)** in the city of Baku, Azerbaijan as hybrid symposium. The symposium co-organizers include GDF (General Directorate of Forestry, Turkiye), IUFRO Division 3.0 and FETEC Platform.

The aim of the symposium was to discuss the most recent scientific researches and professional works related to Forest Transportation solutions and IT applications for Natural Disaster Management with attendance of international researchers, practitioners, and relevant shareholders.

On behalf of the entire organizing committee, I would like to thank all the participants of the symposium and express my best wishes to those who contributed during the preparation and organization stages of the symposium.

**Dunay Badirkhanov**  
*Symposium Chairman*  
*Azercosmos, Baku, Azerbaijan*

**TABLE OF CONTENTS****Full-Paper Oral Presentations**

Using GIS-based Network Analysis to Evaluate the Accessible Forest Areas Considering Wildfires: The Case of Sarajevo .....	1
Determining the suitable forest road route in Landslide Hazard Areas: An UAV Application.....	11
Comparison of Forest Roads According to Ecological Capability Using AHP and GIS.. .....	19
Decision of Drainage Structures on Forest Roads by Netcad-Nethydro Module in Flood and Overflow Scenarios.....	30
Monitoring of Forest Roads During the Lack of Forest Managerial in Hyrcanian Forest .....	37
Assessment of Forest Fire Damage by Using Deep Learning Method.....	46
The Importance of Realtime Scanning Radars in Determining Flood Levels: The Case of the Kastamonu - Bozkurt Flood in June, 2022 .....	56
Study of the Clearing Limit of Road Considering Features of Different Environmental Units in a Deciduous Forest.....	62
Evaluating the Effects of Forest Roads on Forest Fire Using Sentinel-2 Satellite Images – A Case Study for Cokertme Fire in Turkiye.....	70
Application of space information and digital elevation model for monitoring lowland and mountain forests of the Zaqatala region of Azerbaijan.....	76
Determination of Work Efficiency and Physical Workload During the Winching Operation by Farm Tractor .....	87

**Abstract Oral Presentations**

Evaluation of GIS-based Forest Road Route Planning Criteria in Landslide Susceptible Areas .....	98
Regional Evaluation of Landslides between 1950-2020 in Turkiye by Trend Analysis .....	99
Investigation of the Relationship Between Landslide and Forest Roads via OpenGIS® Web Map Services (WMS) .....	100
Using GIS-based MCDS methods for Generating Forest Fire Risk Maps .....	101
Fire susceptibility Analysis Considering its Impacts on Biodiversity of Lowland Forests in Azerbaijan .....	102
A Spatiotemporal Analysis of Carbon Storage in Urban Ecosystem After Forest Fire.....	103
Wildfire disasters in Albania as a Major Hazard to Forest Resources .....	104
Forest Fire Susceptibility Mapping Using Maximum Entropy Method a Case Study in the Northeast of Turkiye .....	105
Determination of post-Fire Condition with Terrestrial and Remote Sensing Techniques in Burned Young Oak Forest .....	106
Operational Planning Procedure for Salvage Harvest after Disasters .....	107
Problems of Integral Assessment of Natural and Anthropogenic Origin Environmental Risks in Azerbaijan.....	108
Forest Fire Related Accidents in Turkiye .....	109
Analyzing Landslide Susceptibility of Forest Roads by Analytical Hierarchy Process (AHP).....	110
Evaluating the Design and Construction of Forest Roads in Landslide-Prone Areas Using Machine Learning and Remote Sensing Techniques.....	111
Comparison of Hand-Held Mobile Laser Scanning and Terrestrial Photogrammetry for 3D Modelling of Post-Wildfire Erosion Plots .....	112
Using GIS Techniques for Investigating the Optimum Locations for Fire Watchtowers .....	113
Wind-driven Fires in Northeastern Turkiye.....	114
Visibility analysis of fire lookout towers: The Case of Edremit State Forest Enterprise in Turkiye.....	115
Importance of Forest Road Networks in Forest Firefighting Activities .....	116
The Effect of Spatial and Temporal Variation of Land Use Change on Some Soil Properties in Mediterranean Karst Ecosystems.....	117
Assessment of Particulate Matter Risk in Post-Fire Logging Operations .....	118
Evaluation of the Effect of Stabilization Techniques on Forest Road Cut slopes: A Review .....	119

Quantity and Type of Logging Residues Following Cut-to-Length and Full-Tree Salvage Logging Systems in Damaged Mountain Forests ..... 120

The Future and Social and Environmental Aspects of Industrial Greening of Akmola Region in Kazakhstan..... 121

**Full-Paper Oral Presentations****Using GIS-based Network Analysis to Evaluate the Accessible Forest Areas Considering Wildfires: The Case of Sarajevo****Dževada Sokolović<sup>1\*</sup>, Muhamed Bajric<sup>1</sup>, Abdullah E. Akay<sup>2</sup>**<sup>1</sup>University of Sarajevo, Faculty of Forestry, Sarajevo, Bosnia and Herzegovina<sup>2</sup>Bursa Technical University, Faculty of Forestry, Bursa, Turkiye[\\*dz.sokolovic@sfsa.unsa.ba](mailto:dz.sokolovic@sfsa.unsa.ba)

---

**Abstract**

The forest fire is one of the greatest environmental disaster on forest ecosystems. In order to effectively fight against forest fires, it is essential for ground team to access fire areas and start firefighting within in critical response time. Therefore, it is important to evaluate the forest areas that the ground team can reach in critical response time. In this study, GIS-based network analysis method was used to evaluate the capabilities of ground team to arrive forest areas promptly considering the forested areas in Canton Sarajevo in Bosnia and Herzegovina. In the solution process, the effectiveness of establishing new fire stations (20) was evaluated by comparing the results obtained in the case where only the former stations (12) were taken into account. The optimal route and associated response times of firefighting teams to potential fire areas were generated considering the previously occurred forest fires (58 fires) in the region. The results indicated that about 18% of the forested areas were accessible considering the former fire station while accessible forest areas increased up to 45% considering the new stations. When analyzing the previously occurred forest fires, it was found that 33 fires were reached in the critical response time considering former fire stations. On the other hand, the accessible forest fires increased up to 56 fires for the case of new fire stations in the region.

**Keywords:** *Forest fires, GIS, Network Analysis, Fire stations, Fire teams*

---

**1. Introduction**

Forest fires are one of the most important abiotic factors that damage the sustainability of forests. A significant amount of human resources and budgets are allocated for the fight against forest fires. In addition to the damages they cause to forests, these fires can also cause loss of life and property in nearby settlements. Forest fires are fires that partially or completely burn all flammable materials (trees, standing tree, leaning logs, grass, leaves, dry trees and branches, etc.) in the forest ecosystem and tend to spread freely due to the open environment (Eroglu, 2009). Combustible material, oxygen and temperature factors come together to start the combustion event.

There are three types of forest fires including cover fire, canopy fire and ground fire. Cover fire and canopy fire are mostly encountered among the fire types (Çanakcioğlu, 1993). The causes of forest fires are grouped as accident, negligence and carelessness, intention, lightning and unknown cause. The correct estimation of the factors affecting the fire ensures successful results in firefighting activities. The most important factors affecting fire are combustible materials, weather conditions and topographic conditions (Şakar, 2010).

Forest fire are common in Bosnia and Herzegovina in spite of the fact that this area is not of high risk in Europe. There are two critical periods of fires: spring (March-April) and summer



### **Full-Paper Oral Presentations**

(July-August), although forest fires occasionally may appear all over the year. Spring fires cause local people burning weeds and other plants remains, when clean their land, located next to forests. Summer fires are closely related to visitors and rates of damages they cause are far higher than spring ones (Uščuplić, 2001).

In order to perform firefighting jobs safely, the precautions to be taken before and after the fire must be determined in advance. The planning of the fight against forest fires, which is a comprehensive and complex process, is important in terms of the precautions to be taken in the early response to the fire. The main goal is the protection of forests. In order to prevent forest fires, communication between the forest and the public, necessary training and determination of importance should be provided (Çanakçioğlu, 1993). Fire response teams are groups of workers equipped with the necessary tools and materials to control and extinguish the fire. Fire response teams in the fight against forest fires are grouped under five groups: initial response team, ready force team, mobile team, fire-truck team and aerial team (helicopter, plane) (Akay and Kılıç, 2015).

It is the initial response team that start the first fight against forest fires. The locations of the initial response team depend on the degree of fire sensitivity, the amount of access road available in the forest, availability of necessary sources such as water and electricity, etc. In order to be able to respond effectively to forest fires, the time of transportation of the initial response team to the fire area by road should not exceed the critical response time. The critical response time varies depending on the fire sensitivity of the burned area (GDF, 2008). The fire sensitivity rate of a region is determined by the number of fires in that region, the ratio of the burned area to the area of the forest management unit and the fire constant (Mol, 1994). The concept of fire sensitivity has been developed in order to be able to rank forests for fire sensitivity and to show the status of forests with known sensitivity rate compared to other forest lands (Küçük and Ünal, 2005).

By using GIS technology, it is more effective and economical to quickly access and analyze the necessary information for the work to be done before, during and after the fire (Küçük and Bilgili, 2006). Akay et al. (2009) implemented a GIS-based decision support system application using the network analysis method in order to determine the optimum route for the ground crew fighting forest fires to reach the fire areas as soon as possible. Akay et al. (2014) used the Network 2001 program to determine the optimum road route to reach the fire area promptly. In the study, a database consisting of various data layers was developed using ArcGIS program. In order to provide access to areas that could not be reached during the critical response time, alternatives have been put forward such as improving the existing road networks and improving their technical standards, increasing the average speed of transportation.

In this study, it is aimed to determine the forested areas that can be reached by the initial response team in Canton Sarajevo during the critical response time by using the GIS-based network analysis method. In the solution process, the effectiveness of the new initial response teams identified in the study area was determined. Additionally, the optimal routes to potential fire areas were generated considering the previously occurred forest fires between 2016 and 2022 in the region.

## Full-Paper Oral Presentations

### 2. Material and Methods

#### 2.1. Study Area

The study was implemented in the border of Canton Sarajevo in Bosnia and Herzegovina. The total area is about 127000 hectares in which 70254 ha is covered with forests and public enterprise KJP "Sarajevo-šume" d.o.o. Sarajevo manage on this area. The city of Sarajevo is located in a valley at an average altitude of 520-750 m and it is surrounded by mountains Trebević 1629 m, Igman 1647 m, Bjelašnica 2067 m and Treskavica 2088 m. On 24% of the total analyzed area, a steep terrain slope was recorded and that is limiting factor for road construction and firefighting activities. An additional problem for access to forest areas is also mined forest areas from the last war (Figure 1).

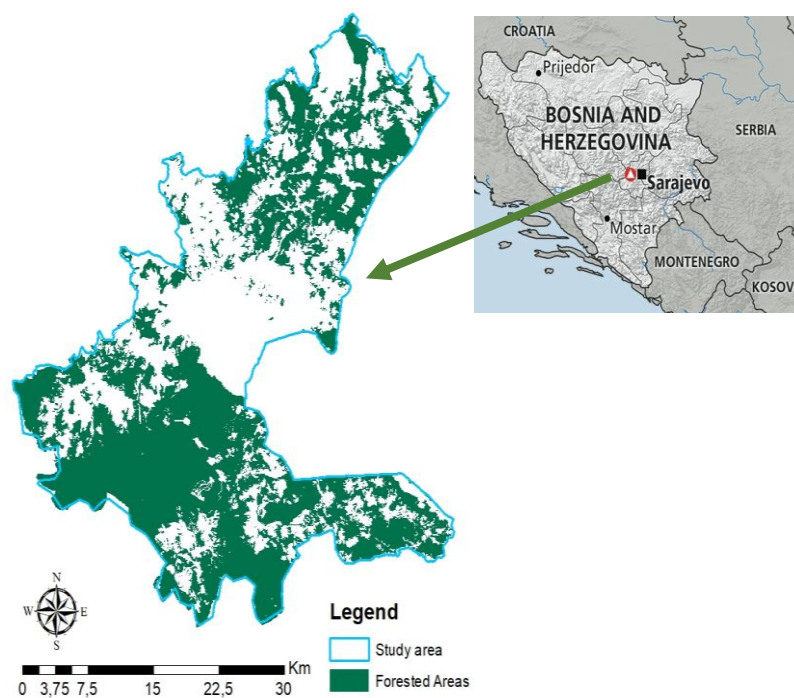

Figure 1. Study area

In Sarajevo, the summers are warm and mostly clear and the winters are very cold, snowy, and partly cloudy. The average temperature typically varies from 10.9°C to 11.7°C. The hottest month is July with an average temperature between 20 and 23,5°C but maximum daily temperature goes up to 38,5°C. The area effected by the mid-European continental climate from the North, and the Mediterranean climate from the South. The main species are beech, fir, spruce, Scots and European pine, oak and common hornbeam. The forests in the study area is estimated as second degree sensitive to forest fire which means critical response time is 30 minutes (GDF, 2008).

#### 2.2. GIS Database

The GIS database was generated to perform the network analysis using ArcGIS program. The road network, forest map, and locations of the fire stations and previous fires data were provided from the Forest Management Department. The map of the road network is indicated in Figure 2. In the study area, there are total of 20 fire stations where 8 of them were relatively new stations. The location of the fire stations and previous fires are shown in Figure 3.

**Full-Paper Oral Presentations**

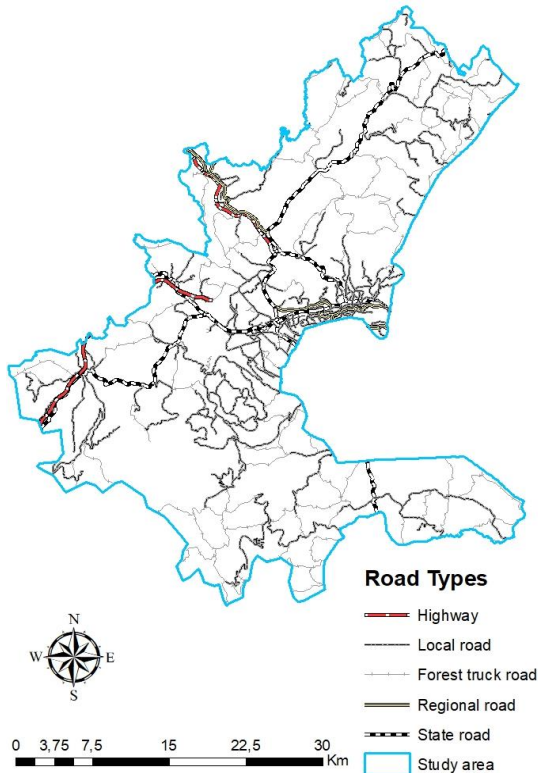

Figure 2. Road network map

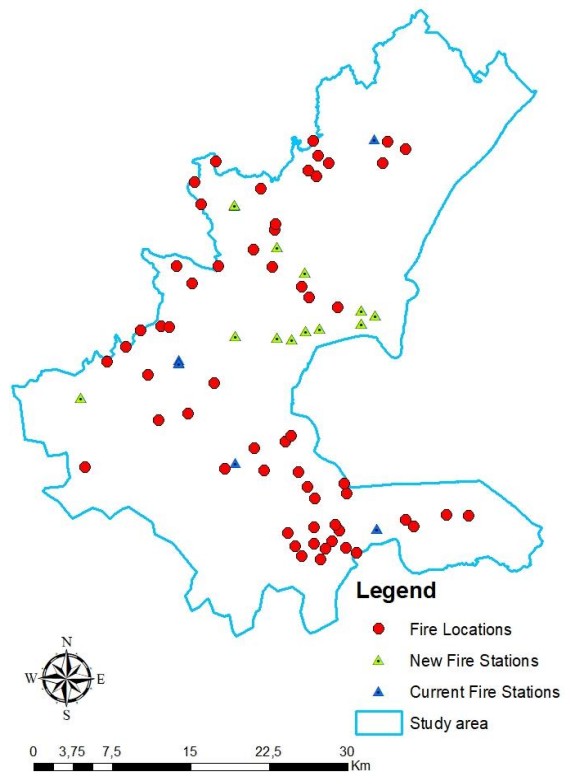

Figure 3. Fire stations and fire locations

**2.3. Network Analysis**

In order to conduct network analysis method first a network database needs to be generated in ArcCatalog module of ArcGIS program. This database was based on the average travel time of fire truck on each road section in the road network layer. Travel time can be calculated depending on the length of the road and the average speed of the vehicle. The average vehicle speed varies according to the road types. Therefore, the fields titled length (km), road type, vehicle speed (km/hour) and travel time (minutes) are generated for each road section in the Attribute Table of the road data layer.

Path lengths were found using the Calculate Geometry tool in the Attribute Table. Road types are classified under five groups as highway, state road, regional road, local road, and forest truck road depending on the current information of the study area. Average fire truck speeds according to road types are given in Table 1.

Table 1. Average fire truck speed based on road types

Road Types	Average Speed (km/hr)
Highway	80
State road	60
Regional road	60
Local road	50
Forest truck road	30

Finally, the transportation time for each section was calculated using the Field Calculator tool in the Attribute Table by using the following formula:

### Full-Paper Oral Presentations

$$t_i = \frac{l_i}{v_i} 60 \quad (1)$$

$t_i$  : Total travel time for section i (minutes)

$l_i$  : The length of section i (km)

$v_i$  : The average vehicle speed for section i (km/h)

60 : Used to convert the transportation time from hours to minutes

After the Network Dataset was completed, the Network Analysis application was carried out using the "ArcMap" module in ArcGIS program. In this application, the New Service Area and New Closest Facility methods, which are under the Network Analysis extension, were applied separately.

#### 2.3.1. New Service Area

In order to increase the effectiveness of the fight against forest fires, it is very important that the initial response team, who are the most important element in the firefighting organization, reach the fire area in the critical response time. For this purpose, the New Service Area method has been applied in this study. In the New Service Area method, which is similar to the Buffer Analysis method as its working principle, a service point determined on the network system is accepted as the starting point and the regions within a total link value (travel time) determined by the user are determined on the network system. In this study, it was aimed to determine the forest areas that can be reached within the critical response time, based on the location of the current initial response team with the New Service Area method. The critical response time varies depending on the fire sensitivity of the burned area. The New Service Area method was applied considering the critical response time of 30 minutes, since the study area was determined as 2<sup>nd</sup> degree fire sensitive areas.

#### 2.3.2. New Closest Facility

With the New Closest Facility method, it is aimed to determine the optimum route between the potential fire areas determined in the study area and the initial response team. First of all, the routes where the existing initial response team can reach each fire area in the shortest time were determined. In this method, the positions of initial response teams and fire areas can be automatically uploaded to the system from the relevant data layers.

### 3. Results and Discussion

#### 3.1. Accessible Forest Areas

Network analysis applications were carried out using two basic data layers generated in the Network Dataset. These data layers; the link data layer that represents the road sections in the road network, considering the transportation times, and the node data layer that represents the intersections of these links (Figure 4). Using the New Service Area method, the forest areas that can be reached in the study area during the critical response time were determined by centered on the positions of the initial response teams. Firstly, forest areas were identified that could be reached by 12 former initial response teams on the road network within 30 minutes. Then, taking into account the new initial response teams, the forest areas where 20 initial response teams could be reached were determined (Figure 5). The results showed that former initial response teams reached 18% of total forest area during critical response time.

**Full-Paper Oral Presentations**

When the new initial response teams were taken into account, the ratio of accessible forest areas has increased to 45% (Figure 6). In a similar study where locations of the initial response teams were evaluated in the city of Tirana in Albania, Haska et al. (2021) reported that 27% of the forest areas in the study area was accessed within the critical response time considering the current the response teams while accessible areas increased up to 65% with the additional response teams.

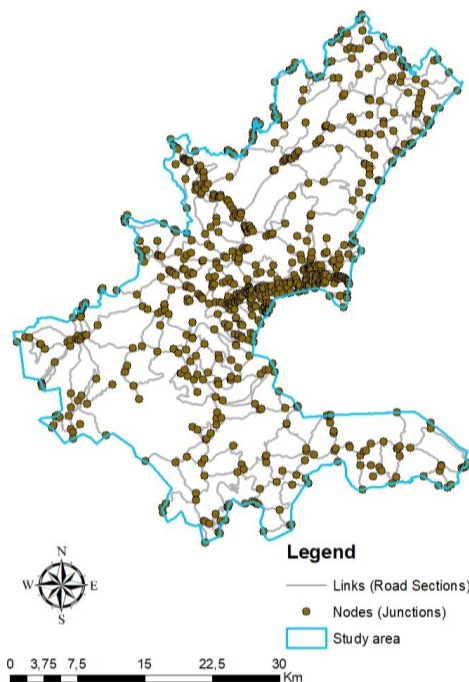

Figure 4. Link and node data layers in Network Dataset

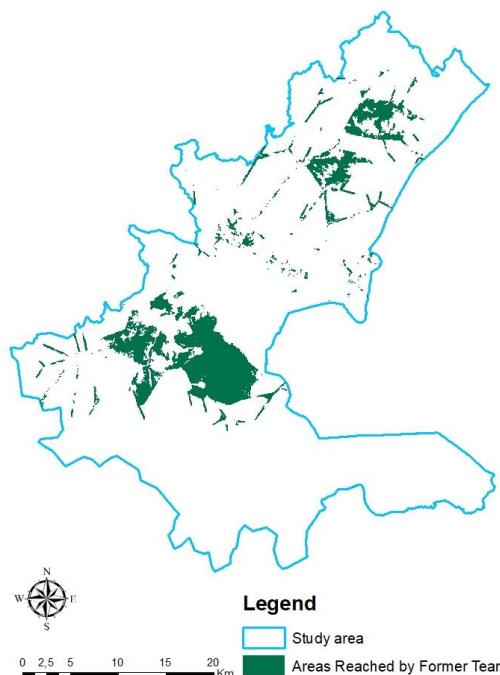

Figure 5. The forest areas reached by the previous initial response teams

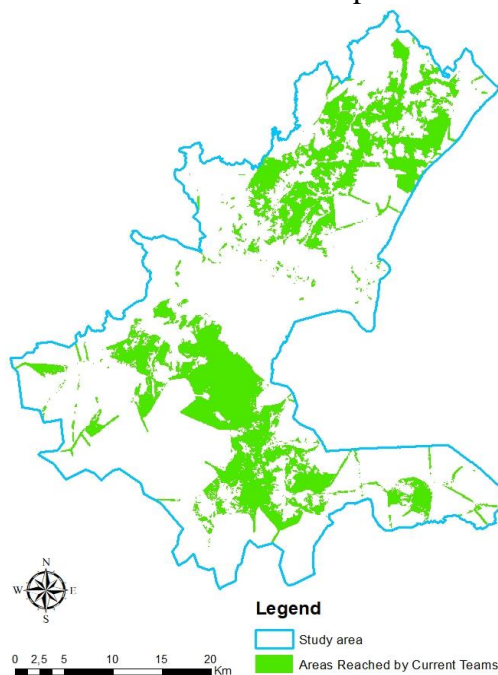

Figure 6. The forest areas reached by the current initial response teams

**Full-Paper Oral Presentations**

**3.2. Accessible Fire Locations**

After implementing New Closest Facility method under Network Analysis tool, it was found that 33 previous fire areas were reached in the critical response time (30 minutes) considering former initial response teams (12 teams) (Figure 7). It was found that initial response team located in the fire station number 8 was able to reach 12 forest fire areas within the shortest amount of arrival time.

For the second run where all of the current initial response teams (20 teams) were considered, accessible fire areas increased up to 56 fire among 58 previous fires (Figure 8). Therefore, including 8 new fire stations allowed initial response teams to reach almost all of the potential fires in the study area, except fire area number 13 and 49 (Table 2). When 8 additional new fire stations established in the study are, initial response team located in the fire station number 15 was able to reach 19 forest fire areas within the shortest amount of arrival time.

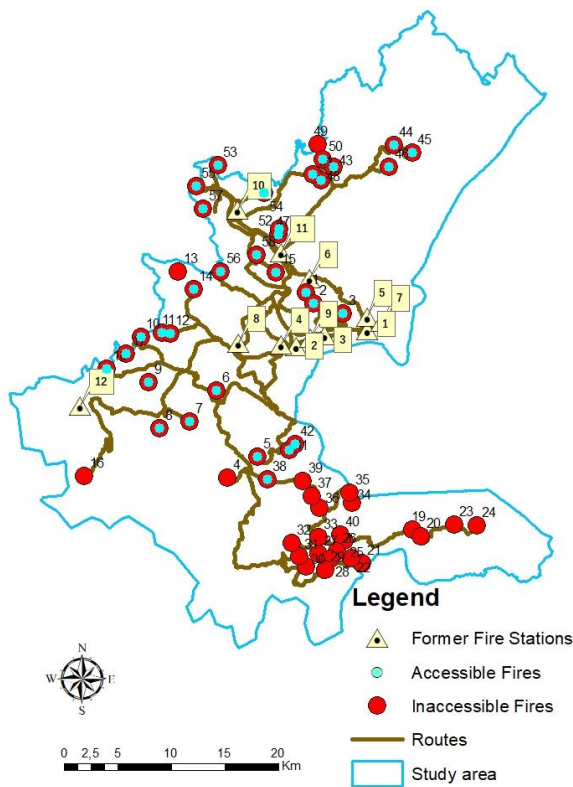

Figure 7. Accessible fire areas by the initial response teams in the former fire stations

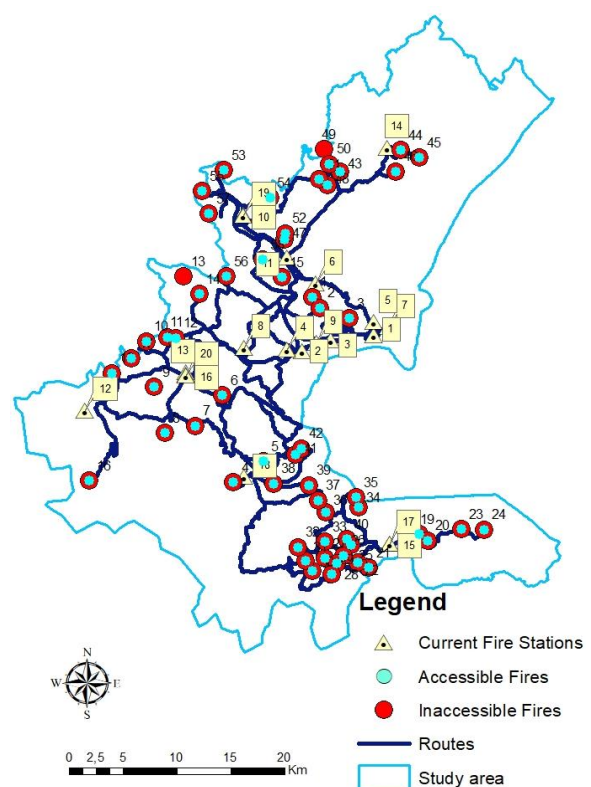

Figure 8. Accessible fire areas by the initial response teams in the current fire stations

It was also found that initial response team located in the fire station number 8 provided the shortest arrival time to only two fire areas (14 and 56). The rest of the fire areas that were accessed by the teams in fire station number 8 were accessed by the teams in the other stations. In a previous study conducted by Akay et al. (212), it was indicated that increasing the number of teams in a specified area would increase the number of accessible potential forest fires within the critical response time. Besides, the firefighting teams need to be established in the right locations in order to reach the fires as quickly as possible by using the shortest route.

**Full-Paper Oral Presentations**

Table 2. Arrival times of the initial response teams to the previous fire areas for two cases

I. Case (Former Fire Stations)			II. Case (Current Fire Stations)					
Fire Stations	Fire Areas	Time (min)	Fire Stations	Fire Areas	Time (min)	Fire Stations	Fire Areas	Time (min)
2	1	10.13	2	1	10.13	15	35	17.11
2	2	10.61	3	2	10.24	15	36	15.51
3	3	5.82	3	3	5.82	18	37	14.07
4	5	23.32	18	4	2.08	18	38	3.76
8	6	16.91	18	5	7.53	18	39	11.41
8	7	17.44	13	6	9.76	15	40	9.48
8	8	13.48	13	7	9.46	18	41	13.77
8	9	14.64	13	8	5.50	18	42	12.27
8	10	16.49	20	9	6.03	14	43	10.56
8	11	11.77	20	10	7.88	14	44	2.86
8	12	10.15	20	11	6.24	14	45	4.77
8	14	9.76	20	12	7.86	14	46	6.70
11	15	11.20	8	14	9.76	11	47	1.87
8	17	17.48	11	15	11.20	14	48	14.35
8	18	21.44	13	16	25.93	14	50	13.82
8	38	29.19	20	17	8.88	19	51	14.65
4	41	21.78	20	18	12.83	11	52	2.04
4	42	23.29	15	19	3.38	10	53	4.46
11	43	11.43	15	20	4.83	10	54	2.98
11	44	17.45	15	21	9.52	19	55	8.13
11	45	19.36	15	22	6.21	8	56	15.42
11	46	16.38	15	23	10.05	19	57	10.59
11	47	1.87	15	24	13.91	11	58	6.58
11	48	15.22	15	25	7.58			
11	50	14.68	15	26	9.04			
10	51	14.68	15	27	16.95			
11	52	2.04	15	28	10.38			
10	53	4.46	15	29	12.16			
10	54	2.98	15	30	18.77			
10	55	8.16	15	31	19.48			
8	56	15.42	15	32	17.36			
10	57	10.63	15	33	13.43			
11	58	6.58	15	34	17.11			

**4. Conclusions and Suggestions**

To minimize the ecological effects of forest fires on forest ecosystems, it is important for firefighters to reach the fire areas by ground transportation in critical response time. In this paper, GIS-based network analysis method was used to assist practitioners for conducting effective firefighting activities through the assessment of accessible forest areas by the initial

### Full-Paper Oral Presentations

response teams. Study was implemented in Canton Sarajevo in Bosnia and Herzegovina where there are 12 former fire stations and 8 newly established fire stations. In the study, previously occurred forest fires between 2016 and 2022 were evaluated in the assessment of initial response teams in the study area. It was found that approximately 18% of the forest areas were accessible considering the former fire station, while it was 45% considering the new stations. It was also found that 33 fire areas were reached in the critical response time, considering the former fire stations. On the other hand, almost all of the forest fire areas (56) were accessible in case of considering new fire stations. The results from the application indicated that establishing new stations for the teams can increase the capabilities initial response teams. For the future studies, optimizing the locations of the initial response teams and as well as building new roads can assist forest managers in fighting against forest fires.

### References

- Akay, A.E., Sakar, D. 2009. Using GIS Based Decision Supporting System in Determining Optimum Path that Provides the Transportation to Fire Zone at the Shortest Time. The Camber of Turkish Engineers and Architectures. The Congress of Geographic Information Systems. 02-06 November. Izmir, Turkiye.
- Akay, A.E., Wing, G.M., Sivrikaya, F., Sakar, D. 2012. A GIS-based decision support system for determining the shortest and safest route to forest fires: a case study in Mediterranean Region of Turkiye. *Environmental Monitoring and Assessment*. 184(3):1391-1407.
- Akay, A. E., Gesoğlu, T., Gülci, N. 2014. Using Network 2001 for Determining Optimum Route in Fighting Against Forest Fires. II. National Mediterranean Forest and Environment Symposium, 22-24 October. Isparta.
- Akay, A.E., Kılıç, E.H. 2015. Providing Engineering Solutions to Forest Fire Access Problems Using Network Analysis Method. *International Conference on Engineering and Natural Sciences (ICENS)*. 15-19 May, Skopje (Üsküp), Macedonia.
- Çanakçioğlu, H. 1993. *Forest Conservation*. Istanbul University Press, Faculty of Forestry Press: Istanbul.
- Eroglu, E. 2009. Awareness Raising Activities on Forest Fires. 1<sup>st</sup> Forest Fires Symposium, 7-10 January, Antalya.
- GDF, 1995. *Application Principles in Preventing and Extinguishing Forest Fires*. Forest management. Publication no: 285, Ankara. 133 p.
- GDF, 2008. *Fire Action Plan*. General Directorate of Forestry. Kahramanmaraş Forest Regional Directorate, Kahramanmaraş. 106 p.
- Haska, H., Akay, A.E., Ergin, H. 2021. Forest road networks-effective infrastructures for extinguishing forest fires. 3rd International Conference on Agriculture and Life Sciences. 1-3 November, Tirana, Albania.
- Kucuk, O., Unal, S. 2005. Determination of Fire Sensitivity Degree: A Case Study in Tasköprü State Forest Enterprise. *Kafkas University Faculty of Forestry Journal*, 6(1-2):28-34.
- Kucuk, O., Bilgili, E. 2006. The conveyance of fire behavior characteristics into practice by using Geographical Information Systems (GIS): A Case Study in Kastamonu. *Gazi University. Faculty of Forestry Journal*, 6(2):262-273.
- Mol, T. 1994. Fire sensitivity classification of the forest enterprises in Turkiye. *Istanbul University Faculty of Forestry Journal*, S-A. 44(2):17-33.
- Sakar, D. 2010. *Determining the Optimum Route Providing the Fastest Transportation to the Fire Areas by Implementing GIS Based Decision Support System*. Master Thesis. Kahramanmaraş Sutcu Imam University, Kahramanmaraş. 90 p.



### **Full-Paper Oral Presentations**

Sarajevo Canton Fire Protection Plan

[https://skupstina.ks.gov.ba/sites/skupstina.ks.gov.ba/files/odluka\\_zastita\\_od\\_pozara.pdf](https://skupstina.ks.gov.ba/sites/skupstina.ks.gov.ba/files/odluka_zastita_od_pozara.pdf)

Uščuplić, M. 2001. Forest fires in Bosnia-Herzegovina and evaluation damages, Works of the Faculty of forestry University of Sarajevo, No 1: 7-17.

**Full-Paper Oral Presentations****Determining the suitable forest road route in Landslide Hazard Areas: An UAV Application****Yilmaz Turk<sup>1</sup>, Remzi Eker<sup>2\*</sup>, Abdurrahim Aydin<sup>1</sup>**<sup>1</sup>Düzce University, Faculty of Forestry, Düzce/Turkiye<sup>2</sup>İzmir Kâtip Çelebi University, Faculty of Forestry, Çiğli Campus, İzmir/Turkiye

\*remzi.eker@ikc.edu.tr

**Abstract**

In the planning of forest roads, the life and durability of the road are important in terms of cost and driving safety. When planning forest roads, passing through areas where the ground is solid is one of the basic principles. In this study, it was investigated whether this landslide still poses a threat to the forest road planned to be built around a historical landslide area that occurred approximately 25 years ago. In the historical landslide, a house and an animal shelter were destroyed and five cattle died. A UAV flight was carried out and in total, 216 geo-tagged images were taken with resolution of 12 megapixel by using a RGB camera in study area. Structure-from-Motion (SfM) algorithm was used for generating Digital Elevation Model (DEM) and orthophoto, which have spatial resolution of 10 cm. In order for georeferencing the model during SfM process, six ground control points (GCPs) were measured. Landslide hazard area boundaries have been determined according to field surveys and UAV data. Then, the road route was overlapped with the identified hazard area. The road section which falls in landslide area was re-planned on a 1/25000 scale map by using NetCAD 5.2 software and was taken out of the hazardous area. In the results of study, it has been determined that there is a landslide hazard in an area of approximately 11 ha and in this area approximately 2 ha slumps were also determined in this area. In addition, the 390-meter the road route, which was in the landslide hazard area, was re-planned and removed from this area.

**Keywords:** *Forest road, landslide, UAV, Düzce, Turkiye***1. Introduction**

Forest roads are invaluable for providing transportation from the establishment stage of the forest to the production stage. Road design and production studies contribute significantly to forestry activities (Abdi, et al., 2009; Acar, et al., 2017). The planning and design of forest roads is essential in order for production processes to be carried out efficiently, safely, comfortably and economically (Abeli, et al., 2000; Aruga, et al., 2005). The implementation of environmentally friendly as well as economically and technically adequate road plans is required. In many countries, forest road networks are realized as a part of the land planning. When a forest road system is planned, many factors must be taken into account, including the condition of the forest, the land structure, climate data, environmental factors, infrastructures, non-wood forest products and services, road-user groups, the value of forest access and national policies (Potocnik, 1996; Gumus, 2009).

Since forest areas consist of a natural ecological environment, it is especially important from an ecological and economic point of view that forest roads, which are the most important

### Full-Paper Oral Presentations

infrastructure facility in forestry studies, are planned on the right route. Because it is an irreversible situation to plan forest roads on the wrong route, which will leave a mark on the forest ecosystem like a knife. The ecosystem will not be able to repair this faulty route for many years. Again, the construction, maintenance and repair of the wrong route will cause great costs. In order to avoid all these, careful and versatile forest road planning is also very important from a technical point of view. Determining the forest road route is the most important and most difficult stage of forest road planning studies. In fact, although the number of crossings that will connect two known points may seem high at first glance, the number of them is not high due to various obstacles and limitations. These barriers are negative cardinal points; landslide, rocky, swamp, etc. form lands (Seçkin, 1984; Bayoğlu, 1997; Erdaş, 1997, Acar, 2004; OGM, 2008). Figure 1 shows the forest roads damaged due to landslides in forest areas.



Figure 1. Forest roads damaged by landslides

Forest road planning and construction works in Türkiye are carried out by the General Directorate of Forestry according to the principles in the "Communiqué No. 292 on Planning, Construction and Maintenance of Forest Roads" (RFD, 2008). First of all, the forest road network of each forest management directorate is planned. Then, the forest roads construction process in the Regional Forestry Directorates (RFD) is started by a reconnaissance team formed by the Machinery Supply Branch Directorate. In recent years, forest road survey and application works have also been outsourced to private forestry companies. Along with the application process of the road, the quantity account is arranged by taking into account the slope, width and slope slopes of the road. After the quantity account, the road construction work is carried out by going out to tender.

Recently, landslide hazard areas have been identified with remote sensing methods and field surveys. Management of mountain hazards and risks requires careful hazard and risk analysis and assessment, which are based on the former events. That's why, documentation of mountain hazards/risks is crucial. In this study, it was investigated whether this landslide still poses a threat to the forest road planned to be built around a historical landslide area (Fındıklı-Aksu Village, Düzce/ Türkiye) that occurred approximately 25 years ago. In addition, a landslide hazard area map was created and the road planned to be built within this area was re-planned and taken out of the area.

## Full-Paper Oral Presentations

## 2. Material and Methods

Within the scope of the study, the 1998-meter section of the 049-coded Type B forest road was selected by the Aksu Forest Management Chief (FMC). Aksu Region is located in the Western Black Sea Region (Düzce / Türkiye) between 40° 47' 08" and 40° 52' 02" north latitudes and 31° 16' 45" and 31° 26' 22" east longitudes (Figure 2). The altitude in the region has a ranges between 355 and 1365 m a.s.l. The average annual rainfall is 816.7 mm and temperatures range from -0.4 to 28.5 °C, with an annual average during the summer of 24.4 °C. The study area forests are managed as high forests and have mixed stands. Tree species in the mixture forests include *Fagus orientalis* Lipsky, *Quercus spp.* and *Carpinus betulus* L (OGM, 2018). In the study area is surrounded with forest and a hazelnut grove is located over the area. The study area covers 5966.5 ha of forest land with a total of 161.5 km of forest roads. The actual road density value of the study area is 21.89 m/ha. A historical landslide area that occurred approximately 25 years ago. In the historical landslide, a house and an animal shelter were destroyed and five cattle died (Aydın, et al., 2018). Figure 3 shows the location where the landslide occurred.

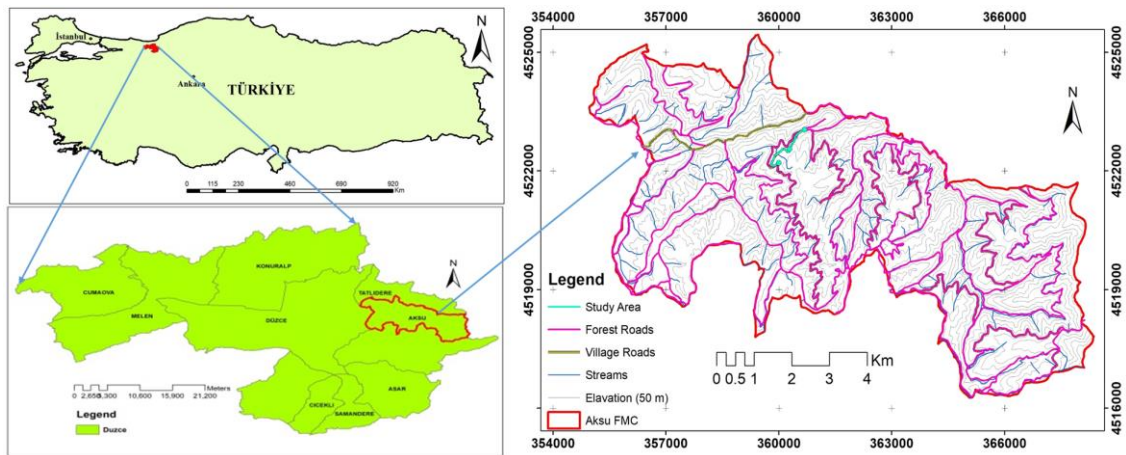

Figure 3. The location where the historical landslide occurred in Fındıklı Aksu Village

**Full-Paper Oral Presentations**

Historical landslide area was mapped with UAV flight conducted on 25 March 2017. The main steps of the workflow of the UAV-based image acquisition can be categorized as follows 1) off-site preparation, 2) on-site preparation and image acquisition, and 3) post-processing (Eker, et al., 2018). The off-site preparation included collecting data about the area and planning the UAV flight. On-site preparation and image acquisition stage includes flights and field works. Ground control points (GCPs) were surveyed in centimetre accuracy (Figure 4). The UAV flight mission was conducted using an off-the-shelf platform called DJI Phantom 3 which has a RGB camera with a resolution of 12 MP (Figure 4). Post processing includes applying the SfM algorithm to generate the DSM and orthophoto, using Agisoft Metashape Professional.



Figure 4. An example of GCP surveyed (right) and DJI Phantom 3 model UAV system (left)

Landslide hazard area boundaries have been determined according to field surveys and UAV data. The forest road route with the 1998-meter section of the 049-coded in this hazard area was re-planned in NetCAD 5.2 software and removed from the landslide hazard area (Figure 5).

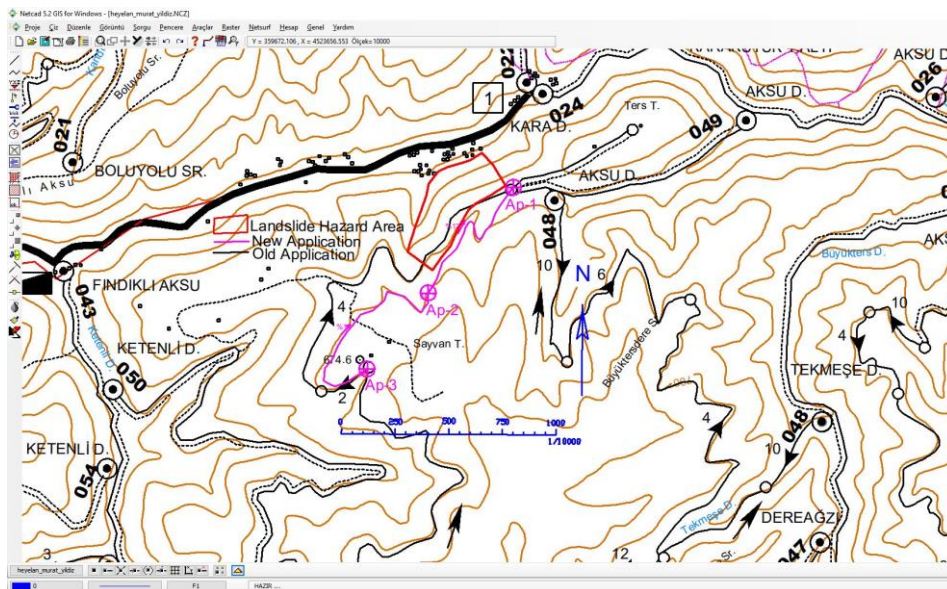

Figure 5. Re-planning the forest road in Netcad 5.2 software

**3. Results and Discussion**

In this study, it was investigated whether this landslide still poses a threat for the forest road planned to be built in and around a historical landslide area. For this aim, a UAV flight was

### Full-Paper Oral Presentations

carried out in the area. The UAV based high resolution orthophotos were given in Figure 6. A UAV flight was carried out and in total, 216 geo-tagged images were taken with resolution of 12 megapixel by using a RGB camera in study area. Structure-from-Motion (SfM) algorithm was used for generating Digital Elevation Model (DEM) and orthophoto, which have spatial resolution of 10 cm. In order for georeferencing the model during SfM process, six ground control points (GCPs) were measured. In Figure 7, the reconstructed digital elevation model of the landslide hazard area was determined between 540 m and 730 m.

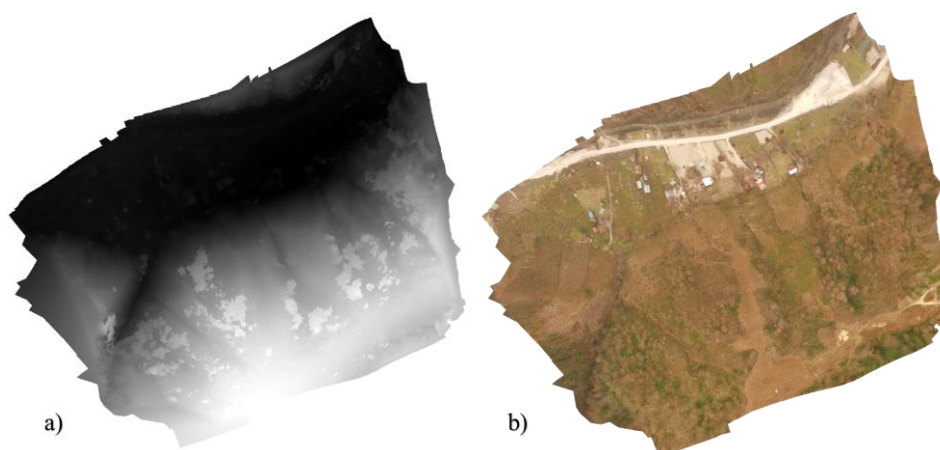

Figure 6. DEM (a) and orthophotos (b) generated from UAV data

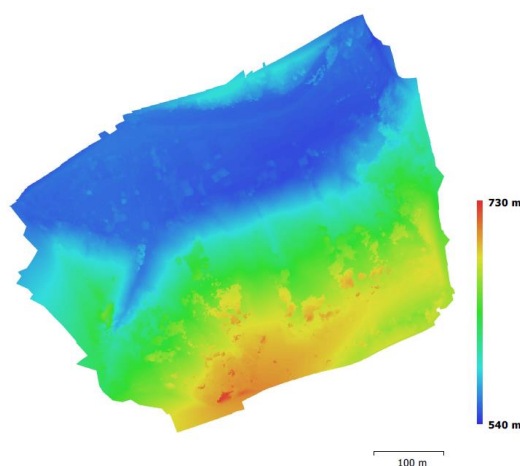

Figure 7. Reconstructed digital elevation model.

Landslide hazard area boundaries have been determined according to field surveys and UAV data. In the study, 11 hectares of landslide hazard area was determined. In this area, slumps were determined in an area of approximately 2 hectares (Figure 8). It has been determined that 390 m of the 049 coded forest road, which is planned to be built around the landslide hazard area, is within this area (Figure 9). In Netcad 5.2 software, the 1998 meter section of the 049 coded road was removed from the landslide hazard area with the re-planning. The road section in the landslide hazard area was determined as 1719 m by re-planning (Figure 10). In Table 1, coordinate summaries of the application points, intermediate distances and longitudinal slope values are given.

**Full-Paper Oral Presentations**

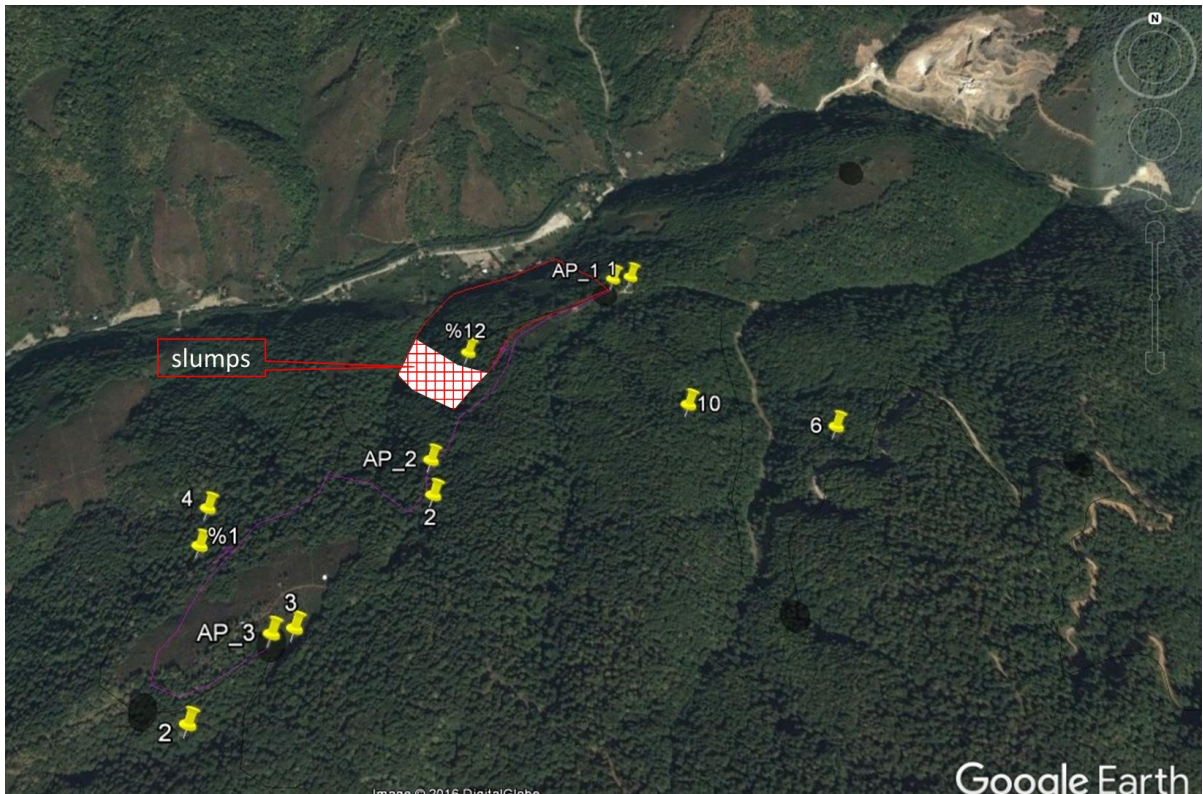

Figure 8. Slumps in the area where there is a landslide hazard (google earth image)

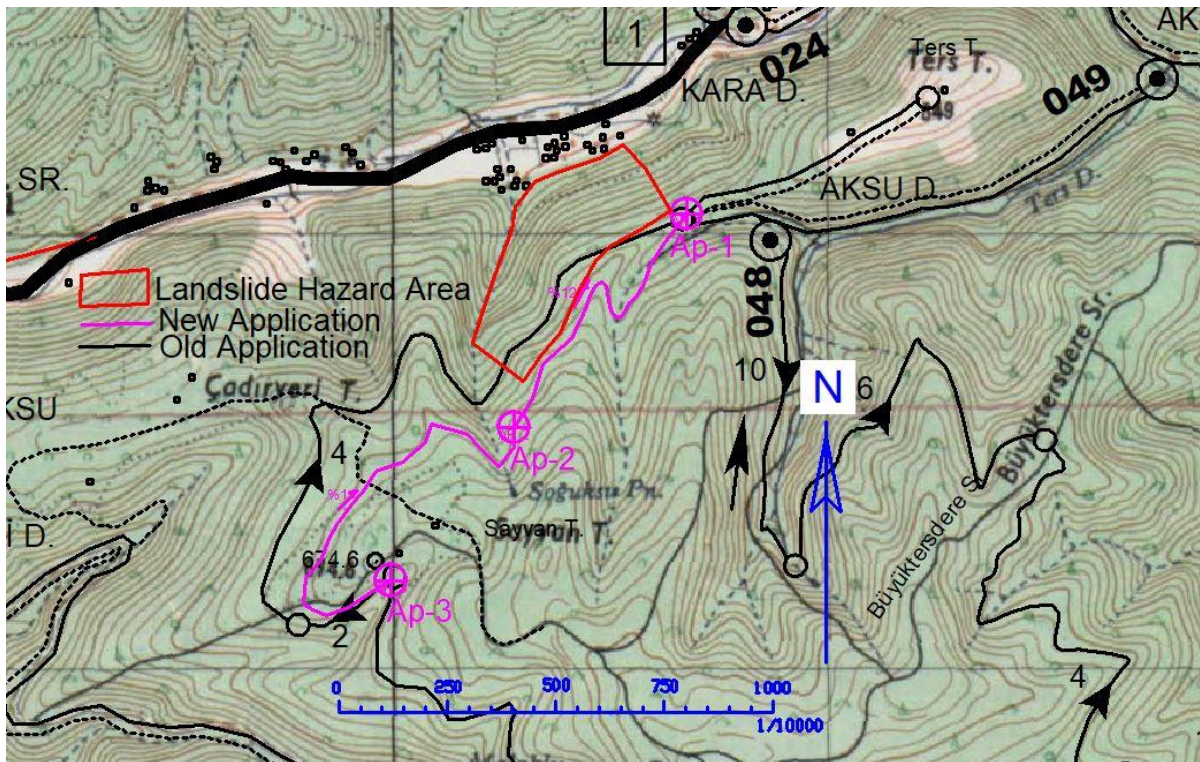

Figure 9. Road section within the landslide hazard area

Full-Paper Oral Presentations

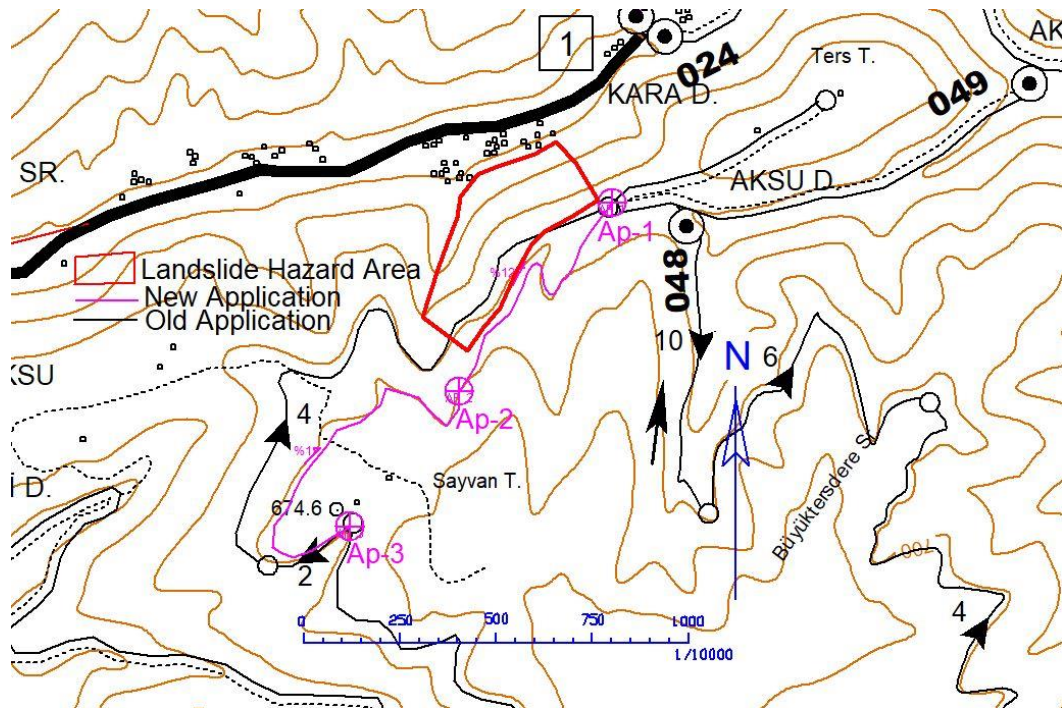

Figure 10. Re-planning the road on the contour map

Table 1. Results for the application created by re-planning

Point No	x	y	Distance Between Application Points (m)		Slope Between Application Points (%)	
			(Ap-1)-(Ap-2)	661	(Ap-1)-(Ap-2)	12
Ap-1	360679.734	4523049.394	(Ap-2)-(Ap-3)	1058	(Ap-2)-(Ap-3)	1

4. Conclusion

In this study, it was investigated whether this landslide still poses a threat for the forest road planned to be built around a historical landslide area. According to the results of the study, it was understood that this landslide continues to pose a threat as a result of the UAV images and field studies. For this reason, 390 meters of the forest road located in the hazard area was re-planned and removed from this area. When planning forest roads, landslide areas should be taken into account and the roads to be built should be reviewed by producing landslide hazard maps.

References

Abdi, E., Majnounian, B., Darvishsefat, A., Mashayekhi, Z., Sessions, J. (2009) A GIS/MCE Based Model for Forest Road Planning. Czech Republic Institute of Agricultural Economic and Information Journal of Forest Science. 55(4), 171-176.  
Abeli, W.S., Meiludie, O., Kachwele, R. (2000) Road Alignment and Gradient Issues in the Maintenance of Logging Roads in Tanzania. International Journal of Forest Engineering. 11(2), 22-29.



**Full-Paper Oral Presentations**

- Acar, H.H., 2005. Orman Yolları, Lisans Ders Notları, K.T.Ü. Orman Fakültesi, Orman Mühendisliği Bölümü, Ders Teksirleri 82, 183 s., Trabzon.
- Acar, H.H., Dursun, E., Gulci, S., Gumus, S. (2017) Assessment of Road Network Planning by Using GIS-Based Multi-Criteria Evaluation for Conversion of Coppice Forest to High Forest. *Fresen. Environ. Bull.* 26, 2380-2388.
- Aruga, K., Sessions, J., Akay, A.E. (2005) Heuristic Planning Techniques Applied to Forest Road Profiles. *Journal of Forest Research.* 10(2), 83–92.
- Aydın, A.; Eker, R.; Turk, Y. Combining Field Surveys and Unmanned Aerial Vehicle Photogrammetry in Landslide Documentation. *International Symposium on GIS Applications in Geography and Geosciences (ISGGG 2017)*, 18 - 21 October, 2017, p. 240, Canakkale, Türkiye.
- Bayoğlu, S., 1997. Orman Transport Tesisleri ve Taşıtları (Orman Yolları) .İstanbul Üniversitesi Orman Fakültesi Yayınları, İ.Ü. Yayın No. 3969, O.F. Yayın No. 434, İstanbul.
- Eker, R., Aydın, A., Hübl, J. 2018. Unmanned Aerial Vehicle (UAV)-Based Monitoring of a Landslide: Gallenzerkogel Landslide (Ybbs-Lower Austria) Case Study. *Environ. Monit. Assess.* 190 (28): 1-14.
- Erdaş, O., 1997. “Orman Yolları – Cilt I”, KTÜ Orman Fakültesi Yayınları, 187, 25, Trabzon, 390 s.
- Gumus, S. (2009) Constitution of the Forest Road Evaluation Form for Turkish Forestry. *African Journal of Biotechnology.* 8(20), 5389- 5394.
- OGM, 2018. Aksu Orman İşletme Şefliği Fonksiyonel Orman Amenajman Planı, Düzce Orman İşletme Müdürlüğü.
- RFD, 2008. Forest roads planning, construction and maintenance, Communiqué no. 292, Ankara.
- Seçkin, Ö.B.,(1984). Bir Orman Yol Projesinde Güzergah Planının Hazırlanması. İ.Ü. Orman Fakültesi Dergisi, Seri B, Sayı 3, s., 92-108.
- Potocnik, I. (1996) The multiple use of Forest roads and their classification. In: Food and Agriculture Organization of United Nations. *Proceedings of the seminar on environmentally sound forest roads and wood transport*, Sinaia.

**Full-Paper Oral Presentations****Comparison of Forest Roads According to Ecological Capability Using AHP and GIS****Farhad Ghasemi Aghbash<sup>1</sup>, Samaneh Razmahang<sup>2</sup>, Iman Pazhouhan<sup>1\*</sup>**<sup>1</sup>Assistant Professor, Natural Resource and Environment Faculty, University of Malayer, Malayer, Iran.<sup>2</sup>M.Sc. Student, Natural Resource and Environment Faculty, Malayer University, Malayer, Iran.\*[imanpazhouhan@malayeru.ac.ir](mailto:imanpazhouhan@malayeru.ac.ir)

---

**Abstract**

This study was performed by using Analytical Hierarchy Process (AHP) and geographic information system (GIS) to the comparison of forest roads according to ecological capability. After multiple studies and according to available information, four criteria and 11 sub-criteria were determined in the form of questionnaires and then were distributed among the experts to prioritize between different criteria. Finally, the degree of importance of each criteria to be determined. Weighting was performed by using paired comparison. In this study expert choice and Arc GIS software were used. The results showed that the criteria in terms of importance are: physiographic (0/409), vegetation (0/210), soil (0/195), and geology (0/187). By combining these factors potential map was prepared and it was found that 16/6% of this district has good ecological potential, 45/2% has a moderate and 38/2% has no ecological potential. In Gorazbon district, a large part of R1 road passes from areas without potential. Whiles R2 road corresponds to ecological potential. The designed road (R3) despite of more compliance with ecological potential but in the end of his path passes from the area with no potential and is necessary for this path changes are made by designing skid trails.

**Keywords:** *Ecological potential, Forest roads, Landform, Analytical Hierarchy Process.*

---

**1. Introduction**

To achieve the basic and optimal harvesting of the forest, it is necessary to create a network of forest roads with sufficient density and access to all section of the forest (Nekoei Mehr et al., 2006). A suitable forest road is essential for the sustainable management of forest. However, improper construction and protection of the forest road network can cause more environmental damage to the forest (Akay et al., 2008), the importance of this issue is the extent that not observing environmental principles in the long term can even lead to the destruction of a watershed (Demir, 2007). A forest road as a service-managerial utility has an undeniably important role in forest recourse because of the economic and environmental cost (Pazhouhan et al., 2017).

Decreasing the area of Hyrcanian forests since they are the only commercial forests of Iran, increases the importance of protecting and using their wood logically and correctly. Therefore, the remaining management of these forests should be based on the evaluation of ecological capability (Moshtagh Kahnemooei, 2001).

### **Full-Paper Oral Presentations**

Failure to evaluate the ecological capability before carrying out any operation in the forest can cause a lot of damage, for example, failure to carry out this process in the three forests section in some areas in Hyrcanian forest (Nav Islam, Lesakoti and Ziarat) has caused an area equivalent to 247.2 hectares to be harvested more than the ecological capability of the forest (Adl and et al., 2006). In Iran, the beginning of the studies related to the evaluation of the ecological potential of the forest and the determination of the degree of desirability of the forest stand goes back to the early 1970s. Ahmadi (2002) performed a study to provide a method for determining the optimal road locating automatically and taking into account environmental aspects, He reported the ability of geographic information systems to routing with a minimum environmental cost. Abdi et al (2008) in research to provide a method for determining the optimal road route automatically and taking into account environmental aspects, reported the ability of geographic information systems to locate forest roads with a minimum cost. Naghdi and Babapour (2009) prepared the stability map using soil texture and bedrock. Their results confirmed that using stability maps, GIS and AHP can be useful methods for the planning of forest road networks in mountain areas in Iran. Norizah and mohd Hasmadi (2012) using the process of hierarchical analysis and judgment of decision-makers stated that slope is the most important influencing factor in the construction of a suitable forest road in Peninsular Malaysia. Çalışkan (2012) compared and analysis of the forest road network in the mountainous region of Türkiye by using the multi-criteria decision-making method and geographic information system, the results of this research showed that the planning and design of forest roads in mountainous areas can be done more accurately with the multi-criteria evaluation method. Çalışkan et al (2019) to find a suitable method for the optimal locating of forest roads and to find an environmentally optimal variant in GIS environment using the hierarchical analysis technique, simple weighting method (SAW), fuzzy and multivariate decision-making method, TOPSIS and promethee method was used, The results of the comparison of the existing network with five new variants from the environmental point of view showed that multivariate decision making, especially promethee technique, got the best results. According to the situation of Iran's biological resources, it is necessary to plan any kind of activities with an attitude towards the talent and capabilities of the land and the principles of sustainable development. There are different methods for evaluating ecological capability and the difference in these methods is due to the difference in ecological models. The assessment of forest road networks using multi-criteria decision-making and in the GIS environment, in addition to being effective (Tampekis et al., 2015), is done with less time and cost (Naghdi et al., 2014). Evaluation of ecological power is a part of the evaluation of environmental power and a tool for strategic forest planning (Rossiter, 1996), during which the potential power or the type of land use is determined or predicted, and in this way, the functions are located at the level of the forest.

Given the importance of Hyrcanian forests, both ecologically and socio-economically, and the impact of forest roads on this precious heritage, a Comparison of existing roads in terms of ecological capabilities was done through the process of hierarchical analysis (AHP) and the use of geographic information system (GIS) techniques.

## Full-Paper Oral Presentations

### 2. Material and Methods

#### 2.1. Material

Khairudkanar forest with an area of about 8000 hectares has eight sections, and the area of Grozban section is 1001 hectares. The Grozban section of Khairudkanar forest is located in the east of Nowshahr between  $36^{\circ} 32'$  to  $36^{\circ} 34'$  north latitude and  $51^{\circ} 36'$  to  $51^{\circ} 40'$  east longitude (Figure 1). The altitude range of the studied area is from 550 to 1380 meters above sea level, and geologically, the parent rock of Grozban is calcareous and belongs to the Upper Jurassic period. The amberge coefficient was used to describe the climate of the region, the climate of the study area was humid–cold by Amberjeh Method.

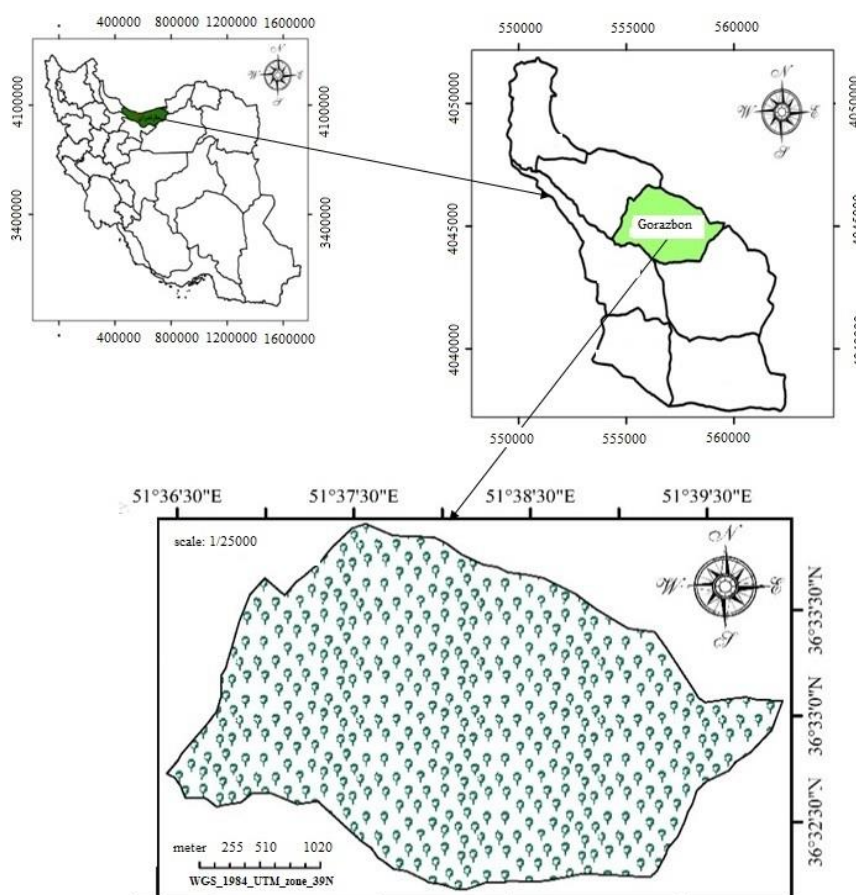

Figure. 1- Location of study area

#### 2.2. Methods

##### 2.2.1. Identification and determination of criteria and sub-criteria

In the current study, four criteria and eleven sub-criteria were selected and investigated according to the subject of study, the natural conditions of the study area, and the prior studies (Ahmadi, 2002; Rafatnia et al., 2006; Abdi et al., 2008; Moahammadian Sammani et al., 2010; Sibi and Rafatnia 2012; Ghomi Motazeh, 2013; Gumus, 2009; Norizah and Mohd Hasmadi, 2012; Pellegrini et al., 2013; Çalışkan, 2013). These criteria and sub-criteria are physiographic factors (slope, aspect, height above sea level), soil (soil texture, soil depth, soil drainage, soil erosion), vegetation (vegetation density, vegetation type, volume), and geology (bedrock).

## **Full-Paper Oral Presentations**

### **2.2.2. Determining the priority and weight of criteria**

Determining the priority and weight of criteria was performed using the Analytical Hierarchy process (AHP) and Geographic Information System (GIS). In this regard, four criteria and eleven sub-criteria were determined and distributed among experts in the form of questionnaires. To prioritize between different criteria, they were weighed and the degree of importance of each criterion in determining the region's capability was calculated. Expert Choice software was used to calculate the final weight of these factors. Finally, the final weight under different criteria was collected in Excel and the Arithmetic mean based on average weight of 10 questionnaires was taken into account.

### **2.2.3. Preparing a map of each criteria and sub-criteria**

Arc GIS software was used to prepare and combine the maps to determine ecological capability. Therefore, the criteria used in this research were layered in the GIS environment. First, TIN (Triangular Irregular Network) and DEM (Digital Elevation Model) maps of the study area were prepared by digitizing the contour line of the Gorazbon district map, then using the TIN, slope, aspect, and elevation maps were extracted and texture maps Soil, soil depth, soil drainage, soil erosion, vegetation density, vegetation type, volumetric inventory, and bedrock were prepared in raw form and with a scale of 1:25000 and were classified according to the type of application and purpose, and finally, the map of each of the criteria and sub-criteria were prepared and produced.

### **2.2.4. Preparation of ecological capability map and comparison of existing roads**

After preparing and combining different maps, the ecological capability map overlapped with the road map, and each of the three roads in this area was compared based on the ecological capability and the extent of their passage through the capability classes. There are two main roads R1 and R2 in Grozban section, R1 road has two branches R1a and R1b. These roads, which are known as 2nd-grade forest roads (main forest roads), have a width of about 5.5 meters, which reaches about 8.5 meters considering the width of the shoulder. The maximum slope of this road is 8%. In addition to these roads, another main road called R3 has been designed to access the upper parcels of Gorazbon district. After preparing and combining different maps, the ecological power map was combined with the map of the existing roads in the region and each of the three roads in the region was compared based on the ecological power and the extent of their passage through the power classes.

## **3. Results**

### **3.1. Weighted effective criteria and sub-criteria in the construction of forest roads**

Based on the results of weighting the effective criteria in the forest road construction, these criteria in order of importance are physiography (0.409), vegetation cover (0.210), soil (0.195), and Geology (0.187). The slope and depth of the soil have the highest and lowest weights between different criteria, respectively (Figure 1).

**Full-Paper Oral Presentations**

Table 1. Weight of criteria and sub-criteria using hierarchical analysis process

Row	Criteria	Weight of criteria	Weight sub-criteria	Weight of criteria
1	Land form	0.409	Slope	0.724
			Aspect	0.143
			Elevation	0.133
2	Vegetation	0.210	Plant density	0.326
			Species type	0.257
			Volume per hectare	0.417
3	Soil	0.195	Soil textures	0.200
			Soil depth	0.158
			Soil Drainage	0.251
4	Geology	0.187	Soil erosion	0.391
			Bedrock	1

**3.2. Prepare an effective criteria map**

The results of different criteria and sub-criteria (physiography, soil, vegetation, and geology) are as follows.

**3.3. Preparation and classification of maps under physiographic criteria**

The slope map was prepared using the TIN map and in the GIS environment was classified into four classes: 15-0, 15-30, 45-30, and more than 45%. The aspect map was also divided into five classes, including north (N), east (E), south (S), west (W), and flat (F). Also, the elevation map was classified into four categories: 760-550, 970-760, 1180-970, and 1380-1180 (Figure 2).

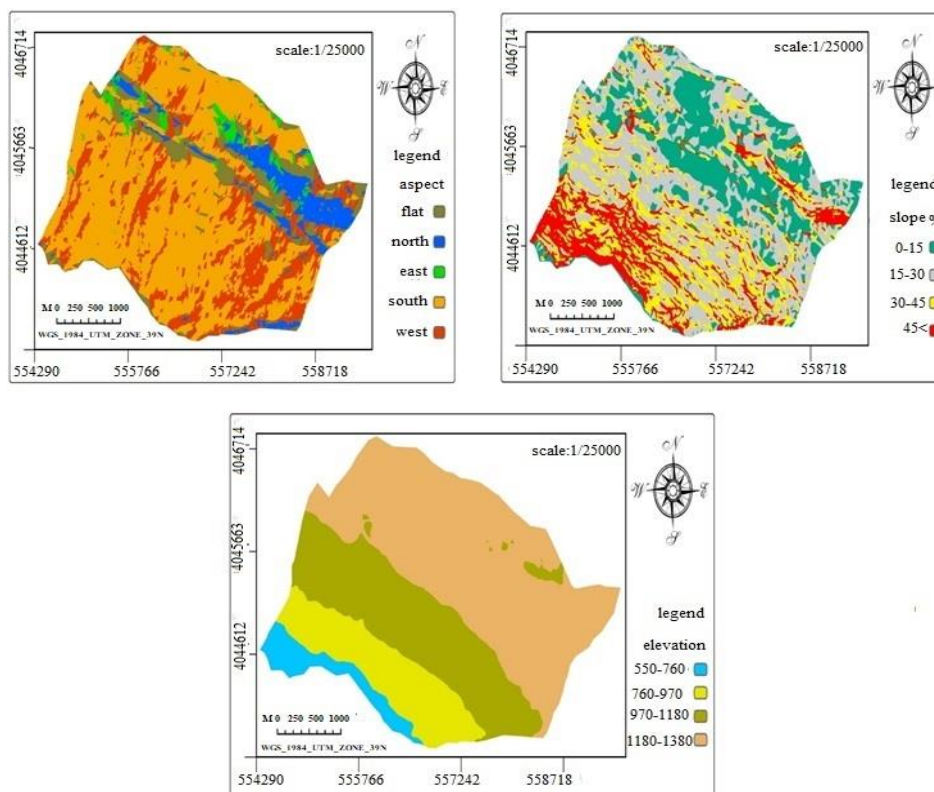

Figure 2. Physiographic sub-criteria maps

**Full-Paper Oral Presentations**

**3.4. Preparation and classification of soil sub-criteria map**

Soil maps were prepared using the data existing in Nowshahr Natural Resources Office (Forestry planning cahier, 2009). According to the soil characteristics, the soil texture was classified into three categories: loamy-clay, clay-loam, and clay. Soil depth was prepared and classified into three classes: very deep, deep, and moderately deep layers. Soil drainage was also classified into three classes moderately well drained, somewhat poorly drained, and poorly drained. Also, soil erosion was categorized into four classes: very high, high, moderate, and low (Figure 3).

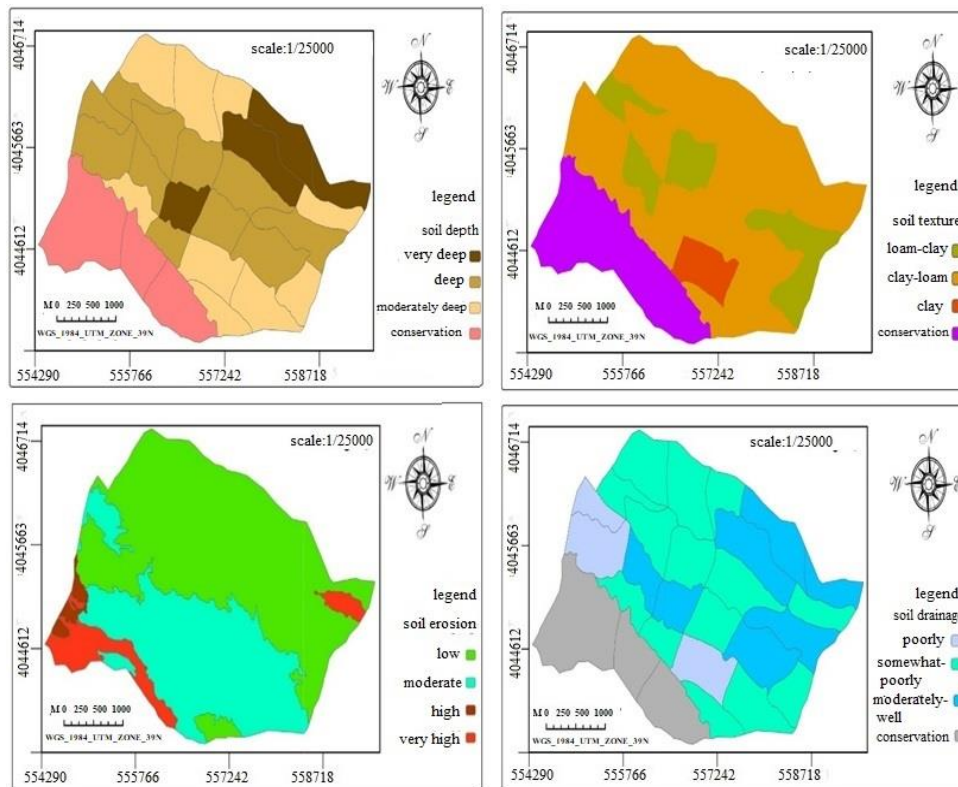

Figure 3. Soil sub-criteria maps

**3.5. Preparation and classification of plant cover sub-criteria**

The vegetation density map is divided into five classes: 200, 300-200, 400-300, 600-400, and 600. The vegetation type also included three Quercus-Carpinus, fagus-Carpinus, and fagus communities. The volume per hectare map was also classified into five categories: 200, 250-200, 300-250, 350-300, and 400-350 (Figure 4).

**Full-Paper Oral Presentations**

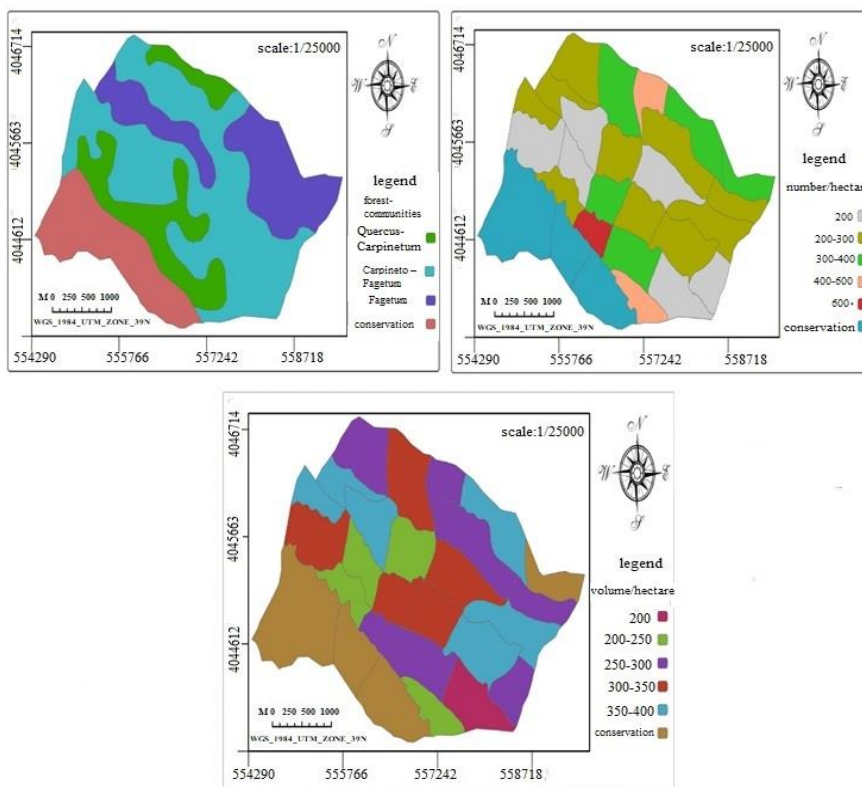

Figure 4. Plant cover sub-criteria maps

**3.6. Preparation and classification of sub-criteria of geology**

Geological formations in Gorazbon district of Kheyroud Forest of calcareous and marine formations in the form of fragmented limestone and dolomite limestone belonging to the Miocene and Pliocene period from the third geological period and calcareous rocks mainly belonging to the Upper Cretaceous period from the second period. In the present study, the lithographic map, according to the lithology of the region, includes two classes, k21 and kt, related to the Cretaceous and Mesozoic periods (Figure 5).

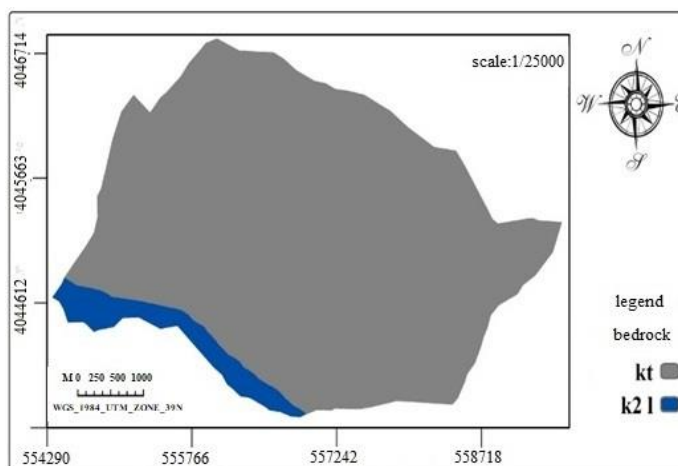

Figure 5. Bedrock map



**Full-Paper Oral Presentations**

**3.7. Results from the preparation of ecological capability classes**

the ecological capability map was divided into three classes of good, medium and without ecological capability (Figure 1). By locating each of the ecological capability classes, it was found that 16.6% of the area has good, 45.2% has medium and 38.2% belongs to the without ecological capability class (Figure 6).

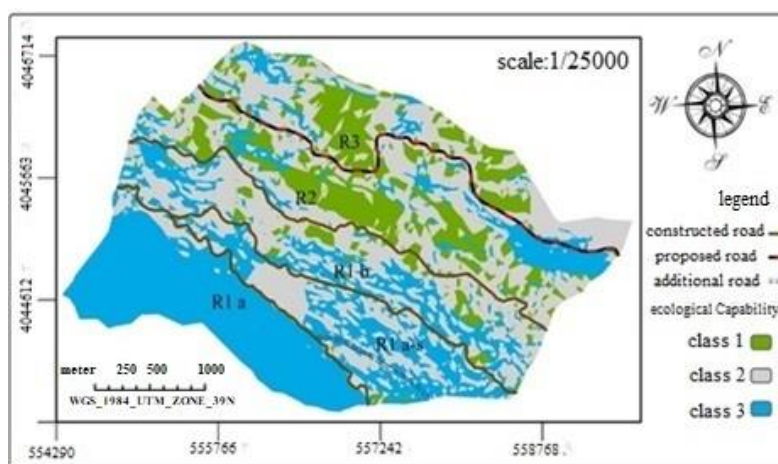

Figure 6. Ecological capability map

**3.8. Characteristics of ecological capability map**

Table 2 shows the characteristics of each of the classes of ecological power in the Grozben region.

Table 2. Characteristic of Ecological capability classes

Characteristic of Ecological capability	Ecological capability classes
Slope 0 to 15%, north aspect, low elevation (in the range of 550 to 970 meters above sea level), Fagum community, limestone bedrock, 400 to 600 trees per hectare, volume more than 350 silos per hectare, Loam-clay soils, very deep soils, well drainage, low erosion	Classes 1 (good)
Slope 15 to 30 percent, western aspect, elevation (970 to 1180 meters above sea level), Fagum-Carpineto community, limestone bedrock, 300 to 400 trees per hectare, volume 250 to 350 silos per hectare, soil texture- Loamy, deep soils, moderate drainage, moderate erosion	Classes 2 (moderate)
Slopes of more than 45%, southern aspect, high elevation (1180 to 1380 meters above sea level), forest communities (Quercus community), limestone bedrock, density (200 to 300 numbers per hectare), low volume (less than 250 silos per hectare), Clay soil texture, moderately deep soils, poorly drainage, very high erosion	Classes 3 (without capability)

**4. Discussion**

Since roads cause damage in nature, the design of forest roads is very important from an environmental point of view, because any wrong change in the fragile forest ecosystem leads to unfavorable results; Therefore, an effective and principled design can greatly reduce the

### **Full-Paper Oral Presentations**

negative effects of road construction on forest stands. The results of the weighting of the criteria and sub-criteria show that the physiographic criterion has a double value compared to other criteria, which is important because of the high weight of the slope factor. After the physiographic criteria, vegetation, soil and geology criteria are in the next ranks respectively. It is to be noted that this ranking does not mean that all the sub-criteria that has more weight than the sub-criteria of the other criteria have preference. For example, among the physiographic sub-criteria, the slope has a very high weight, but the other two sub-criteria (aspect and elevation) do not have significant weight (Table 1). According to Table 1, among the sub-criteria after slope, volume m<sup>3</sup> per hectare and soil erosion are in the next ranks. It should be noted that these weights were obtained for the Gorazbon district of Kheyroud Forest, and in the case of factors that have similar weights, they may be seen differently in other areas; But the extreme difference of the slope factor shows its great importance in the design of roads, especially forest roads. The slope is an important and limiting factor for the forest road network. In general, designers try to make the road pass through low slope points, which will reduce forest destruction and cost (Bodraghi et al., 2007). Eghtesadi et al (2003) consider the slope as an important and limiting factor for road networks. Also, Mohammadian Sammani et al. (2010) stated that slope has the most weight in the design of the forest road network. The slope has the most weight in the design of the forest road network. Therefore, the results of this research are in line with the results of the research of Eghtesadi et al. (2003); Naghdi et al. (2008); Bodraghi et al. (2007), and Mohammadian Sammani et al. (2010).

examination of the roads in the Gorazbon district shows three roads marked with the symbols R1, R2, and R3 (Fig 6). Most of the R1 road passes through area with three or without ecological capability and is better to be blocked at certain times of the year. A large part of R2 has also crossed medium ecological capability, while R3 road has crossed high ecological capability. The design road (R3), despite its greater matching with areas with ecological capacity (classes 1) at the end of its route, passes through patch with ecological capability that needs to be modified, and between the two paths built in the area (R1 and R2), the R2 path is more appropriate and it is better to block R1 for a while or use it at the right time of year. Talebi et al. (24) have also confirmed the GIS capability in the principled design of the road network to assess tourism potential. In general, the results obtained from the weighting of the criteria and sub-criteria indicate that the physiographic criterion is more valuable than other criteria and the main factor of this is slope. Vegetation Criteria, soil, and geology were also ranked after the slope, respectively. Volume per hectare and soil erosion were also ranked among the sub-criteria. As noted, many factors play a role in the design of forest roads. The process of hierarchical analysis leads to the correct and logical prioritization of these factors by comparing these factors and solving the existing complexities, and as a result, the best decision is made. Norizah and Mohd Hasmadi (2012) used hierarchical analysis to develop and prioritize the criteria for the correct location of forest roads, the results showed that the criteria of slope, river crossing, height and existing roads are prioritized respectively. Hierarchical analysis process by comparing these factors and solving the existing complexities leads to correct and logical prioritization of these factors and as a result, the best decision is made (Buğday and Özel. 2019). The results of the investigations carried out in this research showed that before the construction of the roads, the necessary studies and investigations for routing and choosing the appropriate route in terms of ecological potential were not done properly. Therefore, in the design of the forest road network, all environmental and technical aspects should be taken into account and all the

### Full-Paper Oral Presentations

influencing factors should be taken into consideration. The proper combination of these factors will improve the road network and reduce its construction and maintenance costs.

#### 5. Conclusion

The results of current research showed that the necessary studies for forest road locating in terms of ecological capability have not been done properly. Therefore, in designing a forest road network, all aspects of the bio-environment and technical and all influential factors should be considered. The proper combination of these factors together will improve the road network and reduce construction and maintenance costs.

#### References

- Abdi E, Majnounian B, Darvishsefat A, Mashayekhi Z, Sessions J. 2009. A GIS-MCE based model for forest road planning. *Journal of Forest Science*, 55(4):171-176. (in Persian)
- Acar HH, Dursun E. 2015. Reconstruction of the forest road network model with linear fuzzy modelling in the conversion of the coppice forests to high forest enterprises. In *Forest engineering: making a positive contribution. Abstracts and Proceedings of the 48th Symposium on Forest Mechanization, Linz, Austria, 2015* (pp. 249-253). Institute of Forest Engineering, University of Natural Resources and Life Sciences.
- Adl HR, Makhdoom M, Marvi Mohajer MR. 2007. Effective factors on ecological capability in the northern forest of Iran. *Iranian Journal of Forest and Poplar Research*, 15(3):289-300. (in Persian)
- Akay A, Erdas E, Reis M, Yuksel A. 2008. Estimating sediment yield from forest road network by using a sediment model and GIS techniques. *Building and Environment*, 43 (5): 678-695.
- Bodraghi N, Hosseini SA, Lotfalian M, Pormajidian MR. 2007. Evaluation of the existing road network in Vastoon series point view of the positive and negative points using by GIS (Case study: Forests of vastoon district of Mazandaran wood and paper industrial). 87th Tehran Geometrics Conference, National mapping agency.
- Buğday E, Özel HB. 2019. Utilizing a fuzzy inference system (FIS) and modified analytical hierarchical analysis for forest road network planning in afforested lands. *Polish Journal of Environmental Studies*, 28(3):1579-1589.
- Çalışkan E, Bediroğlu S, Yildirim V. 2019. Determination forest road routes via GIS-based spatial multi-criterion decision methods. *Applied Ecology and Environmental Research*, 17(1):759-779
- Çalışkan E. 2013. Planning of Forest Road Network and Analysis in Mountainous Area. *Life Science Journal*, 10 (2): 2456-2465.
- Demir M. 2007. Impacts, management and functional planning criterion forest road network system in Turkey. *Transportation research part A. Policy and Practice*, 41(1): 56-68.
- Eghtesadi A, Sobhani H, Raafatnia N. A. 2003. Study on road network planning for wood transportation at vaz research forest. *Journal of agricultural sciences*, 9(1):33-52. (in Persian)
- Firouzan AH, Abed MH. 2015. Forest road network planning accordance to single selection silviculture method and environmental considerations based on AHP method using GIS. In *Forest engineering: making a positive contribution. Abstracts and Proceedings of the 48th Symposium on Forest Mechanization, Linz, Austria, 2015* (pp. 257-263). Institute of Forest Engineering, University of Natural Resources and Life Sciences.

**Full-Paper Oral Presentations**

- Ghomi Motazeh A, Naghdi R, Mohammadi Sammani K, Taghvaye salami E, Baniasadi R. 2013. Evaluation of AHP Application for Hyrcanian Forests through Road construction potential Map. *Forestry IDEAS*, 1(45): 69-78.
- Gumus s. 2009. Constitution of the forest road evaluation form for Turkish forestry. *African Journal of Biotechnology*, 8 (20): 5389-5394.
- Mohammadi Sammani K, Hosseini SA, Lotfalian M, Najafi A. 2010. Planning road network in mountain forests using GIS and Analytical Hierarchical Process (AHP). *Caspian Journal of Environmental Science*, 8 (2): 151-162.
- Mosaffaie J, Saleh pourjam A, Kamali M. 2018. Evaluation of the ecological capability of aqujan watershed for rangeland and agriculture using gis, *Journal of RS and GIS for Natural Resources*, 9(1) 131-144. (in Persian)
- Naghdi F, Hosseini S, Sadr S. 2014. Ecological capability assessment by using GIS and analytic hierarchy process (Case study: Tabriz Suburb). *Journal of RS and GIS for natural resources*, 5(3): 57-65. (in Persian)
- Naghdi, R and Babapour, R. 2009. Planning and evaluating of forest roads network with respect to environmental aspects via GIS application (Case study: Shafaroud forest, northern Iran). *Proceeding of Second International Conference on Environmental and Computer Science*. Pp. 424-427. Dubai. UAE.
- Norizah k, mohd Hasmadi I. 2012. Developing Priorities and Ranking for Suitable Forest Road Allocation using Analytic Hierarchy Process (AHP) in Peninsular Malaysia. *Sains Malaysiana*, 41 (10): 1177-1185.
- Pazhouhan I, Najafi A, Rouhani AK, Vahidi J. 2017. Effect of Subsurface Materials on Earthwork Operation Costs of Forest Road. *European Journal of Forest Engineering*, 3(2): 44-51.
- Pellegrini M, Grigolato S, Cavalli R. 2013. Spatial multi-criteria decision process to define maintenance priorities of forest road network: an application in the Italian alpine region. *Croatian Journal of Forest Engineering*, 34 (1): 31- 42.
- Petković V, Potočnik I. 2018. Planning Forest Road Network in Natural Forest Areas: a Case Study in Northern Bosnia and Herzegovina. *Croatian Journal of Forest Engineering: Journal for Theory and Application of Forestry Engineering*, 39(1), pp.45-56.
- Picchio R, Tavankar F, Venanzi R, Lo Monaco A, Nikooy M. 2018. Study of forest road effect on tree community and stand structure in three Italian and Iranian temperate forests. *Croatian Journal of Forest Engineering. Journal for Theory and Application of Forestry Engineering*, 39(1): 57-70.
- Rossiter, DG. 1996. A theoretical framework for land evaluation. *Geoderama*, 72 (3): 165-190.
- Sibi A, Rafatnia N. 2012. Consideration of effective factors in design of forest roads using Geographic Information System (GIS). *Journal of Renewable Natural Resources Researches*, 3(1):1-12.
- Talebi M, Majnounian B, Makhdoum M, Abdi E, Omid M. 2018. Forest road network designing for tourism development in Arasbaran protected area using GIS, *Journal of RS and GIS for Natural Resources*. 9(1): 93-112. (in Persian)
- Tampekis S, Sakellariou S, Samara F, Sfougaris A, Jaeger D, Christopoulou O. 2015. Mapping the optimal forest road network based on the multicriteria evaluation technique: the case study of Mediterranean Island of Thassos in Greece. *Environmental Monitoring Assessment*, 187(11): 687.

**Full-Paper Oral Presentations****Decision of Drainage Structures on Forest Roads by Netcad-Nethydro Module in Flood and Overflow Scenarios****Gizem Misirlioglu<sup>1\*</sup>, Selçuk Gümüş<sup>1</sup>**

<sup>1</sup> Department of Forest Engineering, Faculty of Forest, Karadeniz Technical University, Trabzon, Türkiye  
[\\*gizemyorulmaz@ktu.edu.tr](mailto:gizemyorulmaz@ktu.edu.tr)

---

**Abstract**

Drainage structures are facilities built to realize the passage of roads, eliminate the destruction of the road by water, and continue forest transportation in summer and winter. In order to get maximum and long-term efficiency from forest roads, the selection of drainage structures at river crossings is very important. There are various formulas and software used for dimensioning structures. The entire load is left to the planner in the decision-making phase of the “Talbot Formula” used in Turkish forestry. Small mistakes made by the planner appear as the destruction of the drainage structure. One of the most important factors in sizing the drainage structures is to determine the annual peak flow rate of the stream and to evaluate the possibility of overflowing. In this study, Nethydro module of Netcad software was used to determine the annual peak flow amount of the stream where there is a culvert destroyed by the flood. As a result of the analyzes made, the peak flow rate of 100 years was found as 24.7 m<sup>3</sup>/sec. In the communiqué numbered 292, it is stated that the structure to be built in this area will be a bridge according to this flow. As a result, it is thought that eliminating the deficiencies in the Nethydro module can help in the selection of drainage structures in forestry.

**Keywords:** *Forest roads, Drainage structures, Netcad, Nethydro*

---

**1. Introduction**

Forest roads are the most important substructures for exploitation of forests that is renewable natural resource. It is necessary to base the road network to enable reach the goals for planning of forestry operations through sustainability concept. Forest roads are contained in mutual interaction with many factors such as technical economic and environmental featured to achieve these tasks (Gumus, 2015). The planning process of forest roads is the most difficult and important stage, and depending on the wrong route selection, technical and economic problems may arise, as well as negative effects on the natural environment. Forest road construction has a direct impact on the ecological system and if the necessary protective measures are not taken and not carried out in accordance with scientific engineering criteria, they cause negative consequences such as erosion, flooding, landslide and sedimentation (Gorcelioglu, 2004).

Drainage structures; all kinds of pipes, culverts, hamps, trenches, bridges, etc. built along the road route in order to ensure uninterrupted passage of roads, to be protected from the damages of rain and snow waters, and to prevent collapses in cutting and filling. inclined, is made to ensure that the transportation is done regularly and uninterruptedly in summer and winter (Bayoğlu, 1991). Forest roads differ from highways in terms of their location, slope values and geometric standards. A forest road route that follows the valley floor, especially in mountainous

## Full-Paper Oral Presentations

areas and just above the high-water level, requires quite a lot of stream crossings depending on the condition of the land. It is necessary to calculate the flow rate in the streams cut by forest roads and to determine the characteristics of possible floods, to reveal the type and dimensions of the drainage structure to be applied. There are various methods for calculating the flow rate of a stream, and all of these methods are based on precipitation and flood statistics based on long-term measurements of the region where the hydraulic engineering structure will be established. Seçkin (1967), in his study; It has been stated that the first consideration in the selection of a drainage structure is to determine the most economical engineering structure dimensions that will pass the maximum flood flow during the flood in a way that will not harm the road and the environment. For this purpose, he stated that the formula for the first dimensioning was the Tablot formula.

Apart from empirical formulas, there are many software packages produced by different institutions for the analysis of culvert flows (Gumus, 2021). These studies contain specific instructions on hydraulic design procedures (Conesa-García and García-Lorenzo 2013). However, flow rates are entered manually in this software. NetHydro is a Netcad module that defines catchment areas and their drainage networks. It can perform precipitation analysis according to all distribution types, calculate the peak flow rates according to the unit hydrographs and the flood risk areas in the flow branches by calculating the flood flow rates according to different years. NetHydro offers watershed modeling, flood flow calculation and, accordingly, engineering section calculation using a digital terrain model (NetHydro, 2021).

In this study, based on the location of a damaged culvert, analyzes were made with the precipitation data taken from meteorological stations in the Nethydro module and the annual peak flow calculation was determined. According to this peak flow calculation, opinions are presented about the selection of drainage structure.

## 2. Material and Methods

The study area is located between  $43^{\circ} 06' 19''$  -  $31^{\circ} 33' 34''$ , within the borders of Zonguldak province. The main stream of the creek where the box culvert is located is the Alaplı Stream. The annual rainfall of the area is 1222.7 mm. (MGM, 2022) (Figure 1, 2).

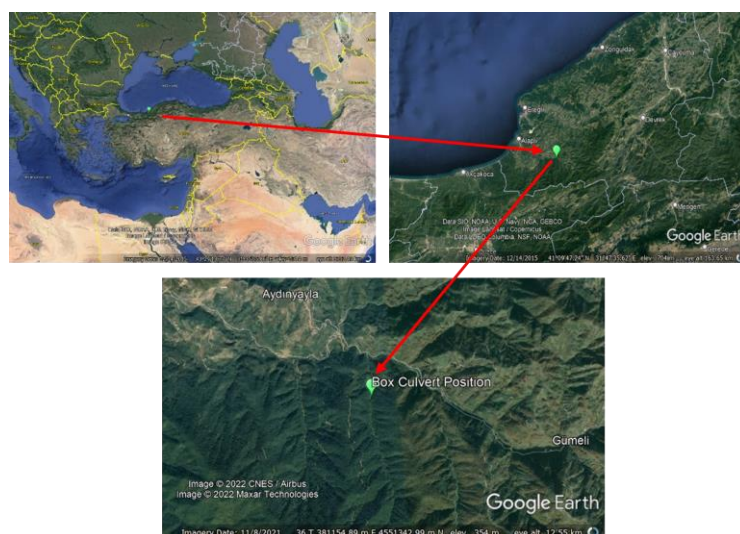

Figure 1. Study area

**Full-Paper Oral Presentations**



Figure 2. The current status of the box culvert

In this study area, analyzes were made on the location of a damaged box culvert, which was built on a stream whose main stream is Alapli. Nethydro module of Netcad software was used for analysis. First of all, a dem map of the area where the culvert is located was obtained. A triangular model was created with the Nethydro module over this dem map. Basin modeling, precipitation analysis and flood peak flow calculations were made over the triangular model (Figure 3).



Figure 3. Triangular model

For the flood analysis, first of all, the basin modeling of the study area was made and the precipitation areas were calculated using the precipitation data obtained from the existing meteorological precipitation stations in the area (Figure 4, 5).

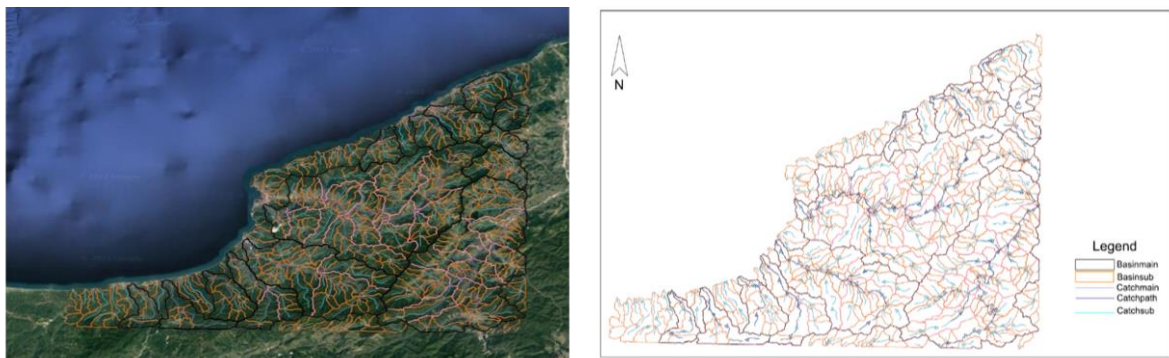

Figure 4. Basin model

## Full-Paper Oral Presentations

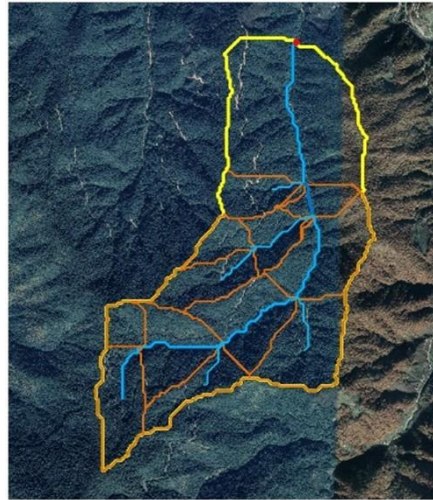

Figure 5. 3D rendering of basin modeling (Basin border and waterways)

By using the daily maximum precipitation in the Akçakoca meteorology station data affecting the basin, precipitation analyzes were made over 6 different distribution functions. As a result of the analysis, it was determined that the most appropriate distribution method in the basin was Log-Pearson Type-3 according to the Smirnov-Kolmogorov test for the most appropriate distribution type (Figure 6).

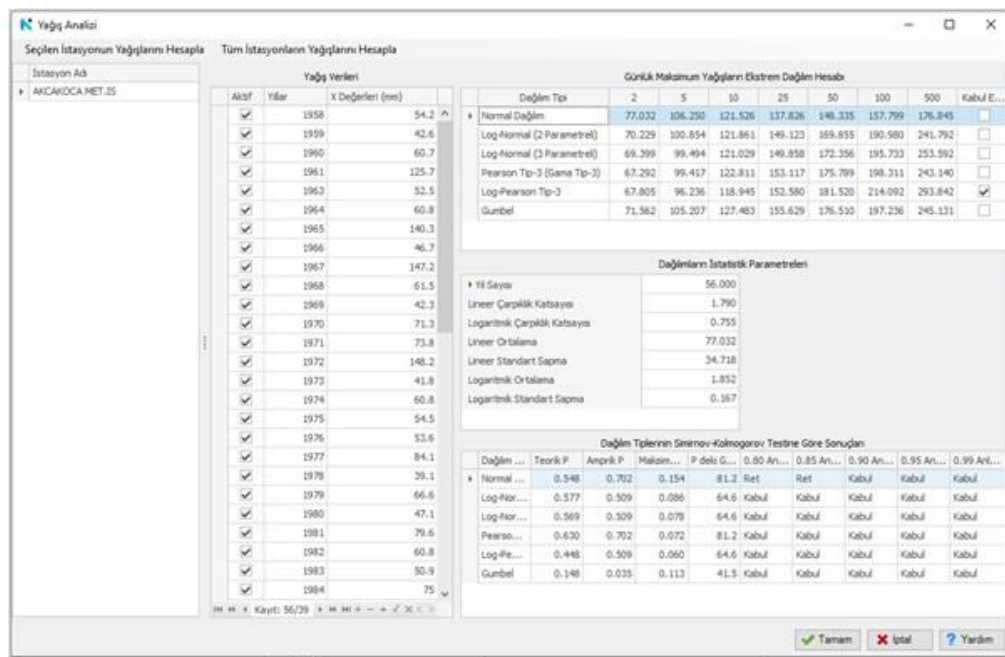

Figure 6. Precipitation data and Smirnov-Kolmogorov test results according to Akçakoca meteorological station

Flood flow calculations are calculated for each basin with different hydrograph methods depending on the area size and concentration time (Toptaş and Gökçeoğlu, 2015). “Synthetic Unit Hydrograph Method” was determined as the most appropriate method based on the attribute information of the basin, which is the basis of this study (Table 1).



**Full-Paper Oral Presentations**

Table 1. Synthetic Unit Hydrograph and results

INPUTS	
Basin ID:	1
Method:	Synthetic Unit Hydrograph
Basin K Coefficient:	0.163
(S) Harmonic Slope	0.089
L (Length) (m)	4982.761
(A) Basin Area (km <sup>2</sup> )	5.469
RESULTS	
(Lc) is the longest distance from the center to the basin entrance or exit point. (km)	2.679
Curve Number (L.Lc/kökS)	44811.476
Qp = A*1*qy*10 <sup>-3</sup> (m <sup>3</sup> /sn/mm)	0.841
User defined qp (lt/sn/km <sup>2</sup> /mm)	200.000
DSİ qp (Yield for Flow for 1mm) (lt/sn/km <sup>2</sup> /mm):	153.724
DSİ Vb (Unit Hydrograph Volume, m <sup>3</sup> )	5469.400
DSİ T (The duration of the hydrograph, hour)	6.596
DSİ Tp (Time to peak for hydrograph, hour)	1.319

**3. Result and Discussion**

Flood and flow calculations are calculated depending on the critical precipitation period of the meteorological station that affects the basin the most, according to the Synthetic Unit hydrograph. Accordingly, the pluviograph coefficient value was determined as 0.50, the minimization factor of the basin as 1.13, and the basin coefficient as 0.16. Depending on the basin area and 2 hours of critical precipitation, the precipitation distribution coefficient was calculated as 0.989 (Table 2). According to the results obtained, the peak flow rate to occur in 100 years was found to be 24.7 m<sup>3</sup>/sec (Table 3).

Tablo 2. Synthetic unit hydrograph method values

Applied Method	T(Hour)	%	MF	YADK	PLV	Last Product
Synthetic Unit Hydrograph	2.00	1	1.130	0.989	0.500	0.559

Tablo 3. 24-hour precipitation recurrence values of the drainage area

		24-Hour Rainfall Recurrence Values of the Drainage Area					
		2	5	10	25	50	100
		67.805	96.236	118.945	152.580	181.520	241.092
		37.899	53.790	66.483	85.283	101.459	119.665
Flow (mm)		0.094	2.097	5.268	11.976	19.283	28.853
Qp=	0.857	0.103	2.294	5.762	13.100	21.094	34.562
K2=	0.163						
Q500 m <sup>3</sup> /sn	49.415	0.1	1.8	4.5	10.3	16.5	24.7
Q1000 m <sup>3</sup> /sn	57.103						

### **Full-Paper Oral Presentations**

The peak flow rate of 24.7 m<sup>3</sup>/sec means that that amount of water will pass through the drainage structure to be applied. According to the communiqué no. 292, it is more appropriate to build a bridge over a stream with this flow (OGM, 2008).

As a result, there are various methods used in the sizing of drainage structures today. Talbot formula is the most widely used in forestry in Türkiye. The value in the Talbot formula is an initial value. According to this value, the size of the cross-section opening is decided by the experience of the planner, taking into account the flow of recurrent peak precipitation (50 and 100 years). The planner's experience and how it will be taken into account are not specified in the communiqué numbered 292 (Gümüş, 2021).

In a study, it was determined that the entrance and exit sections of the culvert were half filled with sediment even though one year had passed since the culvert's exit and entrance levels were below the road level (Öztürk, 2010). In another culvert example given in the same study, it was built perpendicular to the road, in such a way that the flow could not be provided easily. For this reason, it has been observed that all sediment and precipitation waters from the side ditch accumulate at the entrance and exit of the culverts and fill the culverts. In these examples, it is seen that the life of the drainage structures is short as a result of the mistakes made by the planner. In such flood situations, the drainage structures must either be reconstructed or undergo maintenance. Since these transactions will increase the costs even more, they return to the business as a loss.

#### **4. Conclusions**

Errors occur in the sizing of drainage structures due to the fact that the final decision maker of the existing methods is mostly the human hand. It is thought that it would be beneficial to use today's technology in order to eliminate these errors. With Nethydro software, the peak flow rate of 100 years can be found with a series of analyzes without the need for field studies. It is thought that healthier results can be obtained by determining other parameters (vegetation, land structure, soil structure, etc.) that will affect the drainage structure in the area by conducting field studies. It is known that flood formation has a devastating effect on drainage structures. For this reason, it is very important to determine the peak flow amount of the area. For this reason, with Nethydro, a module that can be used, peak flow calculations can be made from the data received from the surrounding meteorology stations, but the pluviograph coefficients for each station are not included in the software, they must be obtained from the meteorology stations and entered manually. In this study, this was not necessary as the area entered only one meteorological station. While working on the module, the software must be taken from the beginning when the software fails and is opened again. It is thought that the improvement of the Nethydro module will be a good step for solving the drainage structure problems in Turkish forestry.

#### **References**

- Bayoğlu, S., Hasdemir, M., 1991. Orman yollarında tesis edilen küçük hidrolik sanat yapılarının seçimi ve boyutlandırılması. *Journal of the Faculty of Forestry Istanbul University*, 41(3-4):17-38.
- Conesa-García, C., García-Lorenzo, R., 2013. Evaluating the effectiveness of road - crossing drainage culverts in ephemeral streams. *Hydrological Processes* 27(12):1781-1796.

**Full-Paper Oral Presentations**

- Gumus, S. 2015. Evaluation of Forest Road Networks Located in Karadeniz Technical University Research and Practice Forest . European Journal of Forest Engineering , 1 (1) , 15-20
- Gümüş, S. 2021. Stream-crossing Approaches on Forest Roads Networks: A Critical Review on Practices in Türkiye. European Journal of Forest Engineering, 7(2), 92-97.
- Görcelioğlu, E. 2004. Orman Yolları-Erozyon İlişkisi. İstanbul: İstanbul Üniversitesi Orman Fakültesi Yayınları
- Netcad, Nethydro <https://www.netcad.com/tr/urunler/nethydro#incele> (Accessed: 10 October 2021)
- OGM, 2008. Orman Yolları Planlaması, Yapımı ve Bakımı, Tebliği No. 292. Orman Genel Müdürlüğü, İnşaat ve İkmal Dairesi Başkanlığı Yayınları, Ankara.
- Öztürk, T., 2010. Orman Yollarında Drenaj Tesislerinin Konumlandırılması İçin Gerekli Esasların Belirlenmesi (Belgrad Ormanı Örneği).
- Seçkin, Ö.B., 1967. Orman yollarında drenaj, İ.Ü. Orman Fakültesi Dergisi, Seri B, Cilt 28, Sayı 1, Sayfa. 149-165, İstanbul.
- Toptaş, T.E., Gökçeoğlu, C., 2015. Taşkın ve heyelan duyarlılığının Netcad NetHydro ve Analist ile modellenmesine bir örnek: Akcaabat (Trabzon), TUFUAB VIII. Technical Symposium, 23 May, Konya. <https://www.tufuab.org.tr/images/dergi/makaleler/7836009139c4eb3.pdf>
- URL-1 <https://www.mgm.gov.tr/veridegerlendirme/il-ve-ilceler-istatistik.aspx?m=ZONGULDAK>

**Full-Paper Oral Presentations****Monitoring of Forest Roads During the Lack of Forest Managerial in Hyrcanian Forest****Mohsen Mostafa**

Mazandaran Agricultural and Natural Resources Research and Education Center, AREEO, Sari, Iran,

[m.mostafa@areeo.ac.ir](mailto:m.mostafa@areeo.ac.ir)

---

**Abstract**

In the current research, the forest roads located in Hyrcanian forest, are being monitored during the regular time interval. The aim of this study is clarifying the road management issues amid the state decision of forest exploitation cessation along with passing on some advice on the maintenance and optimal use of such liner infrastructures. Firstly, the existing road network maps were created on 1:25,000 scale (NCC), using satellite image and mapping by GPS followed by the road sampling in 2021. The Component Technical and Geometrical Specification of each road segment include the Culvert, Ditches, Road surface, cut and fill slopes have been recorded. The sampling was commenced from start to end point in road's segment in each district. In the end, the possible annually and periodically solutions were introduced in order to encourage keeping take effective action on the forest road maintenance operation through the cessation exploitation period as well as the evaluation of the existing road networks.

*Key words: Forest road, Component Technical, Geometrical Specification*

---

**1. Introduction**

Throughout the history of forest management development, forestry plan has been thought of as a key component to obtain forest management objects (Kangas et al. 2006; Linser et al. 2018). The first serious discussion and analyses of forestry plans emerged during the 1960s with the nationalization of forests and rangelands in Iran (Sotoudeh Foumani et al. 2017, Mostafa et al., 2022). In the light of this event and regarding the fact that forest ecosystems require preferential treatment, the forestry plan has been used to manage and harvest forests in some specific parts of Hyrcanian industrial forests in the north of Iran (Gómez et al. 2006). Consequently, the prior plans recently were recklessly abandoned by related state authorities where there is no longer production function in such ecosystems.

At this point in time of approving the forestry plan, road construction was an essential initial stage to forestry plan development. Generally, forest roads are located in heterogeneous biological and climatic conditions. Therefore, the possibility of destruction and blocking the roads up, is high. On the other hand, due to the urgent need to implement forestry projects, forest road annually and periodically maintenance operation is necessary.

The most prominent aspect regarding the forest roads appears to be to take advantage of the roads to make the forest utilization operations as well as to facilitate the removal of forest timber. In the meantime, the blindingly obvious use of forest road is wood transportation,

**Full-Paper Oral Presentations**

forest conservation, ecotourism objective, forest fire management and access to residential spots in forest area. Currently, the ceased forest plan has been considered as a state new approach of Iran’s forest management for some reasons. Consecutively, there are ambiguity over carrying out the essential and routine forest road maintenance in the new approach of the forest management. Although, due to the lack of adequate government funds, the operation became practically impossible to do. Therefore, pursuing the sole purpose of timber harvesting toward forest road and ignoring this linear infrastructure as basic component of forest management could easily lead to the destruction and their perennial uselessness. Overall, the maintenance operation for existing roads seems strongly be crucial through the management approaches bringing about drastically cut down on reconstructing or improving costs. The present project was designed in order to evaluate the forest road managerial conditions in Hyrcanian Vegetative region where being currently undergone a complete logging cessation viewpoint by state decisions.

**2. Material and Methods**

**2.1 Study sits**

The forest districts include Shenrood in Guilan Province and Neka-Zalemrood in Mazandaran Province, Hyrcanian region.

**Shenrood:** Series 7 of Shenrood forest situated in Guilan province. The area of the series is 3707 hectares, latitude is 36°55'15"N to 36°58'29"N, and longitude is 49°50'38"E to 49°57'25"E. The sea elevation range is 1278 to 1924. There are 15 km roads in this series, which built during 1978-1989 (Fig. 1).

**Neka-Zalemrood:** series 5 of Neka-Zalemrood located in Mazandarn province – Sari.

It is situated between latitudes 36°27'41" - 36°31'16"N and longitudes 53°20'13" - 53°23'59" E, encompassing a total area of approximately 1643 hectares, where the altitude varies between 370m and 970 m. There are 22 Km roads in this series which was constructed during 1975-1985 (Figure 1).

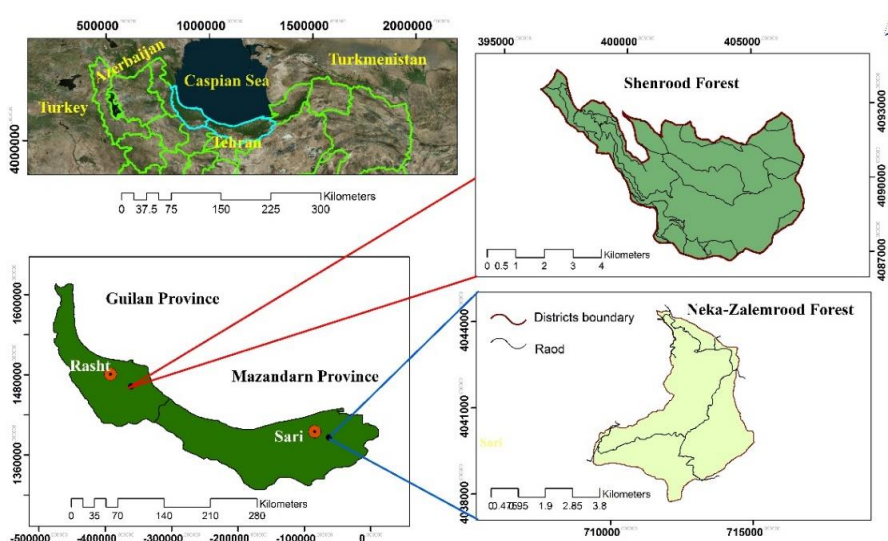

Figure 1. Location and geographical position of the study sites

**Full-Paper Oral Presentations**

**2.2 Road mapping**

The existing road network map was created on 1:25,000 scale National Cartography Center (NCC), using satellite image, and mapping by GPS.

**2.3 Road Inventory**

Road Segmentation in each forest series was performed based on nodes location (segment intersection). Road inventory was commenced from the beginning of the segments. Considering the culverts, the segments were divided into the sections in which the distance between culverts was named as section (Figure 2). Then the technical and geometrical specification of each culvert along with the middle of sections were recorded. It is worth mentioning that if the road distance between culverts were more than 300 meters then the road characteristic would also record from the first third, the middle and the last third.

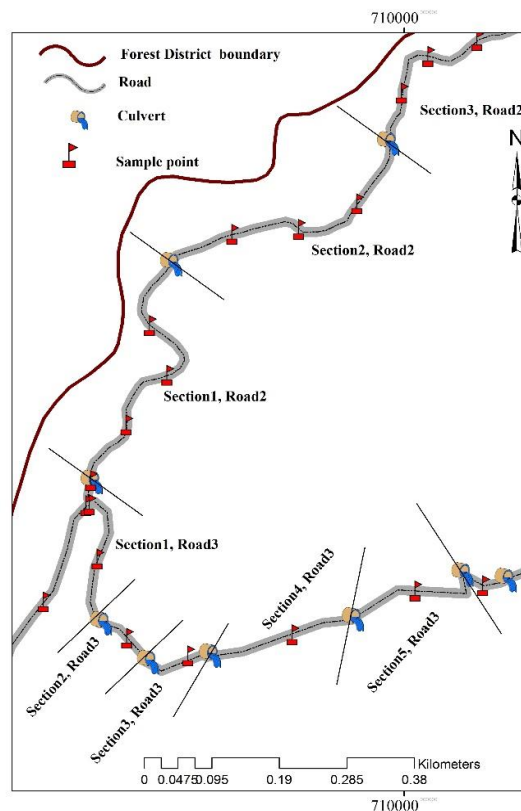

Figure 2. Dividing of road segments to sections based and culvert location in order to road inventory

**3. Results and Discussion**

**3.1 Road surface**

There is a statistical difference between roads and instruction in some road surface elements, according to the results in Table 1. The Traveled way, out slope shoulder and cut shoulder length were significantly different from the standards. The figurative results from the road surface condition after some rehabilitation years are shown in Figure 3.

**Full-Paper Oral Presentations**

Table 1. Comparison of the road geometrics characteristics with standards using One-sample T- Test

Component of road	standard error Average	p - value ±
Traveled way	0.004±2.62	0.00*
Out slope t shoulder	0.04±1.09	0.00*
Cut shoulder	0.03±1.15	0.00*
Length slope	0.16±6.67	0.82 <sup>ns</sup>
Cross slope	0.15±3.91	0.92 <sup>ns</sup>

\*Significant difference, ns, significant difference at the 5% level

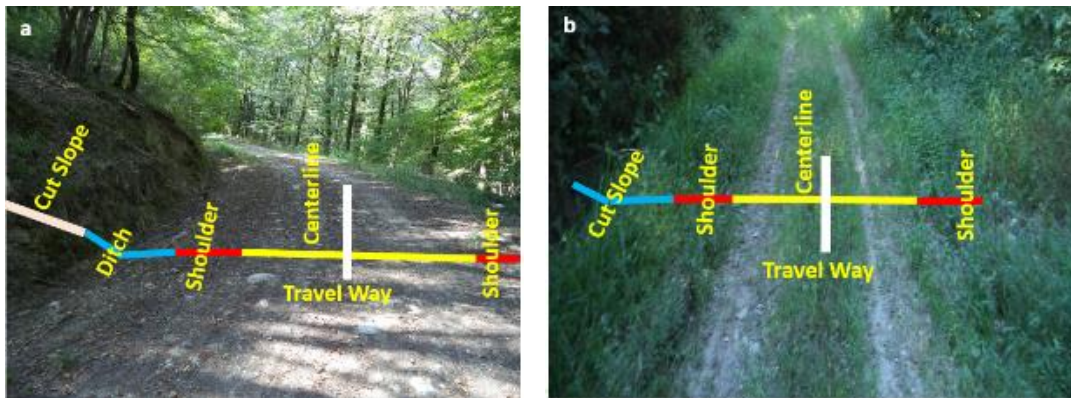

Figure 3. The Road surface elements after 4 years rehabilitation a) the reshaping was conducted in 2017, b) the road surface condition in 2021 without maintenance operation.

In total, the various changes have been occurring in terms of Quantitative Component in the road surface. Likewise, erosion has happened in 52.825 of sample points as the wheel track was observed in 73.53 of the roads. In addition, the overgrown weeds were one of the most important problems in all of the road’s elements specifically in this section, so that this problem has taken place in the 52.94 percent of the road surface. Figure 4 and Figure 5, obviously, feature the actual situation of the road component and the details of Quantitative assessment of the road surface.



Figure 4. Uncontrolled recreational use led to severe erosion on road surface

**Full-Paper Oral Presentations**

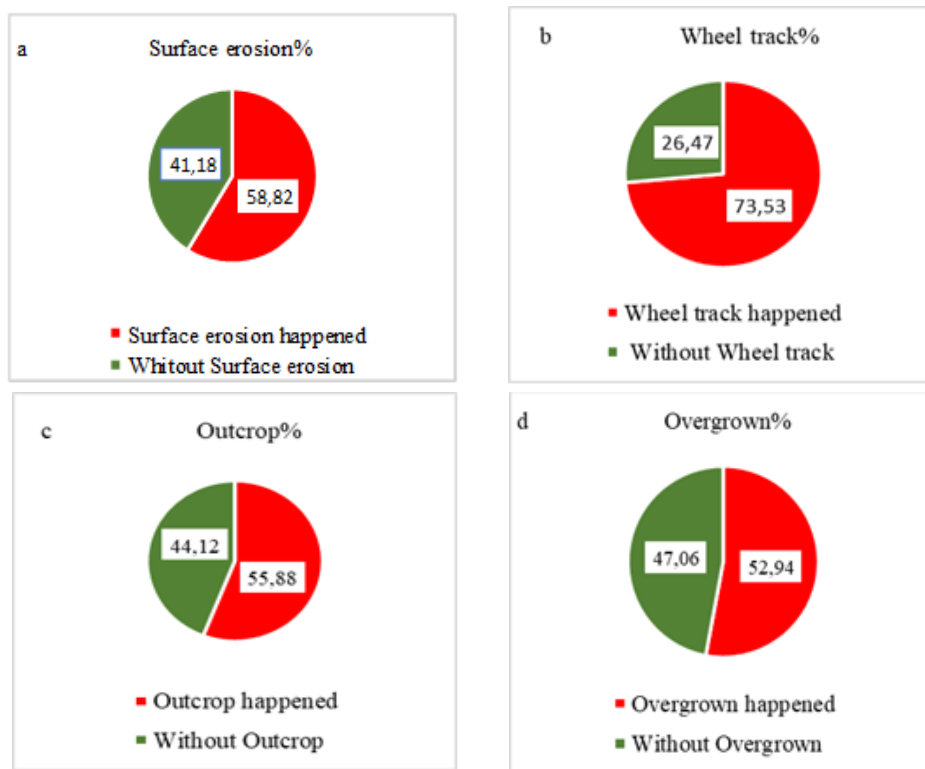

Figure 5. The result of road surface Quantitative assessment a) Surface erosion, b) Wheel track c) Outcrop, d) Overgrown

**3.2 Culverts**

The findings indicated that the studied culverts have not perfectly worked. Figure 6a, 6b show the Intel situation and Outlet scouring in culverts, respectively. Erosion is another setback in the culverts referring to the Figure 6c, 6d, 53.13% and 50% in order, in which the cut slopes and the fill slopes are suffering from the water and the soil erosion. Figure 7 illustrates some failures in pipes across the investigated roads.

**3.3 Ditches**

Most of the ditches were ruined in the length of the studied roads. Figure 8a shows that the 26.47% of ditches were blocked. In addition, the 50% of the observed ditches were spoiled. Considering the Figure 8b, we observed that the erosion has struck in 64.71% of the conveys followed by the scouring and the debris blocking which were other defects in the ditches. Furthermore, the 67.65% and 73.53% of the ditches were suffered from the scouring and debris blocking, in (Figure 7c, d) respectively. Figure 9 illustrates the observed destruction and debris blocking in ditches.



**Full-Paper Oral Presentations**

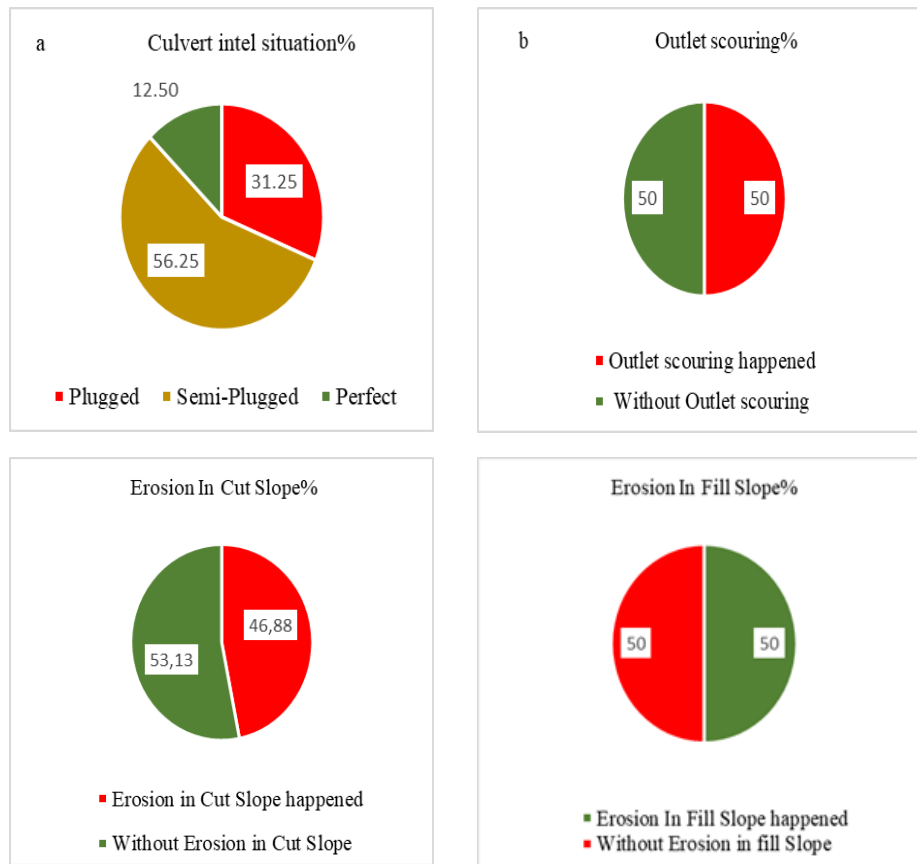

Figure 6. a) Intel situation in pipes, b) Outlet scouring in pipes, c) occurred erosion in culvert's cut slopes, d) the erosion taken place in pipe's fill slopes



Figure 7. Various failures in pipes across the investigated roads, a, b, c) Intel cracking of pips, d) culvert with the destroyed outlet

**Full-Paper Oral Presentations**

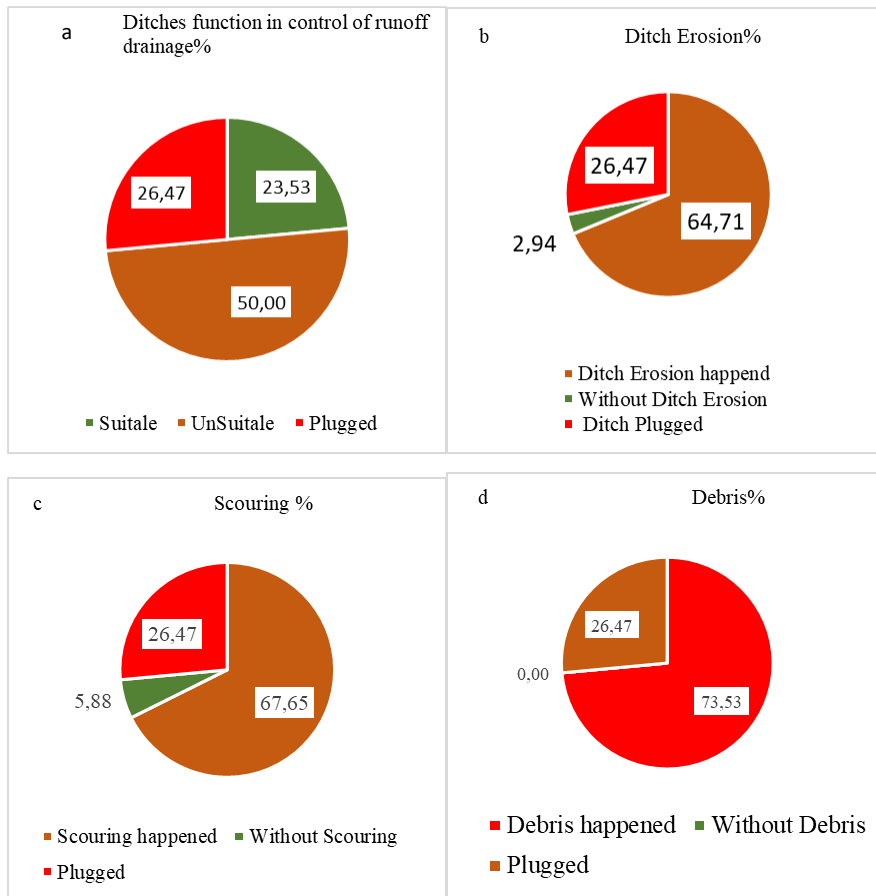

Figure 8. A) Ditches runoff drainage, b) occurred erosion in ditches, c) happened scouring d) debris blocking



Figure 9.

a) Destroying of ditches, b) debris blocking of conveys

**3.4 Cut and fill Slopes**

The erosion and stability were the crucial problems in the cut and fill slopes. Therefore, in the 50% of sampled cut slopes erosion has been observed (Figure 10a). According to the findings in Figure 10b around 85.35 of cut slops were unstable. Such results could refer to the fill slope assessment alike in a way that the 58.82% of the elements were confronted with the erosion (Figure 10c). Besides, the 55.88 of fill slopes were unstable as well. The current condition of the cut and fill slope components are clearly shown in Figure 11.

**Full-Paper Oral Presentations**

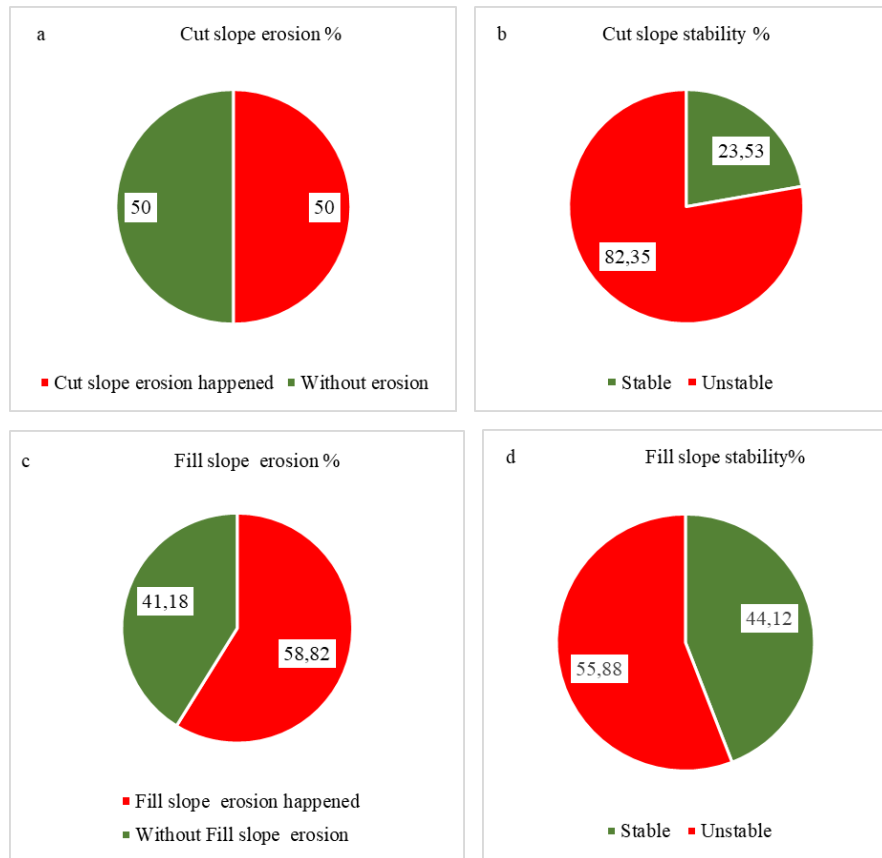

Figure 10. a, c) occurred erosion in cut and fill slopes, b) results of stability evaluation in cut and fill slopes.

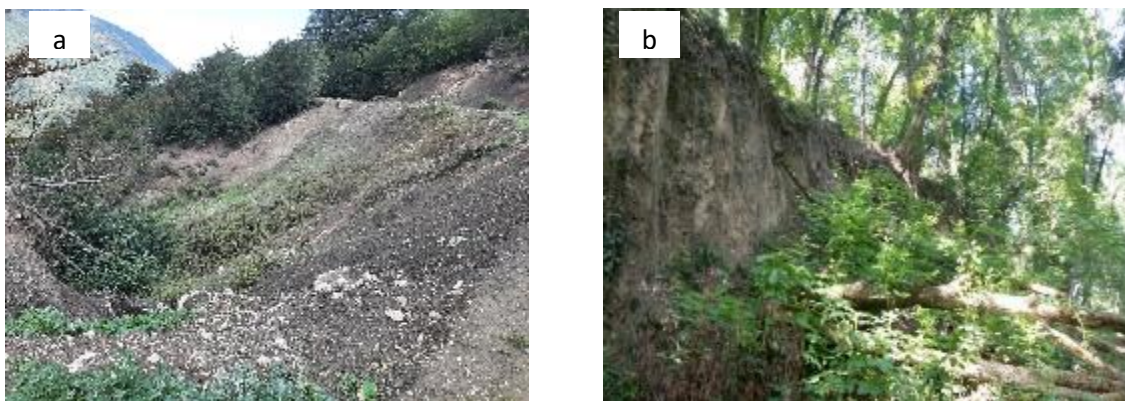

Fig 11. Destruction of fill slopes (a) and cut slopes (b)

**4. Conclusion and Suggestions**

The study has shown that keeping the annual and periodical maintenance and repair services of forest roads can ensure the preserve of the initial investment and significant decrease in the serious risk of developing the other potential problems associated with both natural and human-made ones and should not be ignored. The results highlight an emphasizing need of regular maintenance for all of the roads in order to accesses the whole forest area to fulfill a variety of purposes include logging, firefighting and conducting the silvicultural practices.

### **Full-Paper Oral Presentations**

Overall, the research came to conclusion that the forest roads should be continuously repaired and protected. It means that the roads should have stable surface, cut and fill slopes along with the operating drainage system. Additionally, the Culvert and ditches are regularly well worth getting cleaned out from the debris averting them from plugging up by sediments and over weed growth.

#### **References**

- Kangas, A., Kangas, J., Laukkanen, S. 2006. Fuzzy multicriteria approval method and its application to two forest planning problems. *Forest Science*.52: 232–242.
- Linser, L., Wolfslehner, B., Asmar, F., Bridge S.R.J., Gritten D., Guadalupe V., Robertso G. 2018. 25 years of criteria and indicators for sustainable forest management: Why some intergovernmental C&I processes fourished while others faded. *Forests*. 9(9): 515.
- Sotoudeh Foumani, B., Rostami Shahraji T., Mohammadi Limaiei S. 2017. Role of political power in forest administration policy of Iran. *Caspian Journal of Environment Science*. 15: 181–199.
- Mostafa, M., Hatami N., Espahbodi K., Asadi A. 2022. Fuzzy analytic hierarchy process (FAHP) applied to evaluating the forest management approaches. *Journal of Forest Science*. 68(7):236-276.
- Gómez, T., Hernandez, M., Leon, M.A., Caballero R. 2006. A forest planning problem solved via a linear fractional goal-programming model. *Forest Ecology and Management*. 227: 79–88.

**Full-Paper Oral Presentations****Assessment of Forest Fire Damage by Using Deep Learning Method****Aybike Göksu Bektaş<sup>\*1</sup>, Abdullah E. Akay<sup>2</sup>, İsmail Rakıp Kardeş<sup>1</sup>**<sup>1</sup>Karabük University, Department of Computer Engineering, Karabük, Türkiye<sup>2</sup>Bursa Technical University, Faculty of Forestry, Bursa, Türkiye[\\*aybikebektass@gmail.com](mailto:aybikebektass@gmail.com)

---

**Abstract**

Forest fires are considered as one of the important natural disasters that can seriously damage forest ecosystems, harm wildlife and threaten human life. In order to prevent forest fires or minimize their effects on ecosystems, fire damaged areas should be accurately determined and appropriate prevention plans should be developed. This study aimed to investigate capabilities of using deep learning method for assessment of fire damaged areas. Convolutional neural network (CNN), which is most commonly used method in deep learning applications, was used for classification of burned and unburned forest areas. The algorithm was developed on Google Colab, as it provides its own GPU and allows the necessary libraries to be used automatically. The basic categorization logic was performed by using the Pytorch library and class assignment has been made to the existing object. In this study, the training data for burned and unburned areas were collected from the Sentinel-2 satellite images of before and after fire, covering the forest fires that took place in Antalya in Summer 2021. The test analysis was run for the forest fire that took place in the same year using the satellite image. In the solution process, 60 data were used for training stage while 40 was for test stage. Alexnet was used as the training model based on total of 50 trainings. During the training stage, the results of the accuracy, loss and kappa metrics were evaluated for each step. At the end of the study, the Accuracy value was found to be 96%, the Recall value was 98.96, the Precision value was 96.94, while the F1 Score value was 97.94. The accuracy evaluation suggested that the success of the model was sufficient in the study.

**Keywords:** *Forest fires, Fire damages, Deep Learning, Machine Learning*

---

**1. Introduction**

Fires cause a lot of damage to natural resources such as vegetation, water and air. In addition, it causes loss of life and property in settlements or agricultural areas around forests. Today, fighting forest fires and making the right decisions in planning have become even more important. Forests, which are one of the important factors for the sustainability of natural life, face a serious threat due to wildfires. (Fidanboy et al., 2022). It is known that most of the forest fires are caused by humans. Therefore, determining the damage caused by forest fires and identifying the damaged areas is an important step in the firefighting activities. Satellite images provide a quick and easy way to obtain the necessary data for the analyses to be made before and after the forest fire events (Polat and Kaya, 2021).

Today, one of the developing and problem-oriented Technologies used in the solving complex problems is artificial intelligence. Deep learning, which is the sub-title of solution-oriented and

## Full-Paper Oral Presentations

artificial intelligence, has started to be used in many areas such as security, agriculture, and forestry in order to obtain more accurate results (Yilmaz et al., 2020). It has been reported that effective solutions can be produced in the fight against forest fires by using deep learning methods. Deep learning methods were implemented in previous studies to estimate the fire risk and hazard potentials using the factors that cause forest fires (Fidanboy et al., 2022).

The most successful deep learning architectures in image analysis processes are convolutional neural networks (CNN). CNN architectures emerged in the 1980s. CNNs are deep artificial neural networks mainly used to classify images, cluster them by similarity, and perform object recognition in scenes. The most important assumption regarding problems solved by CNN should not have spatially dependent features. (Bayat et al., 2017). CNN architectures have not come to the fore until 2010 due to the lack of compatible hardware and software (Karakurt and İşeri, 2022).

This paper presents how deep neural networks implemented in modern GPUs can be used to efficiently learn highly distinctive image features for the purpose of fires hazard estimation. The performance of the deep learning model was evaluated in classification of the burned and unburned areas based on satellite images.

## 2. Material and Methods

### 2.1. Study Area

In Summer 2021, large size forest fires occurred in several places in Türkiye including Antalya, Köyceğiz, Marmaris etc. It was reported that total of 160000 hectares of forest land has been damaged during these fires. In this study, Marmaris and Köyceğiz fire which happened at the end of July in 2021 was studied (Figure 1). The dominant species in the region is Brutian pine that is highly sensitive to forest fires. In the study, two Sentinel-2 satellite images, one captured before the fire (18 July, 2021) and the other after the fire (17 August, 2021), were analyzed to detect fire burned areas (Figure 2, Figure 3, Figure 4).

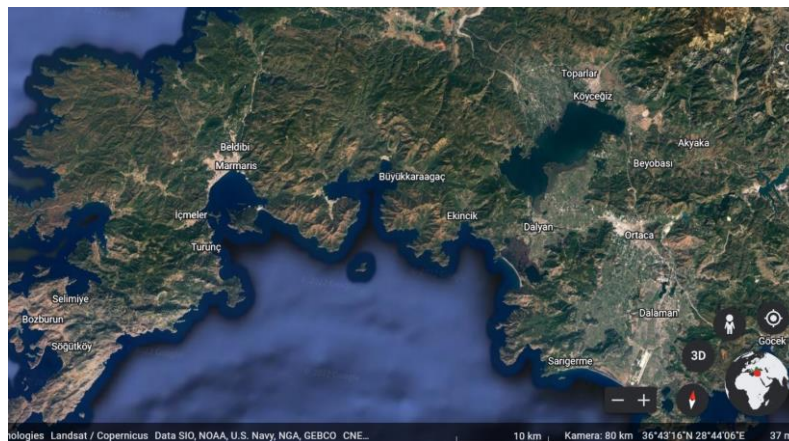

Figure 1. Marmaris and Köyceğiz provinces

**Full-Paper Oral Presentations**

Figure 2. Sentinel-2 satellite images taken in 18 July, 2021 (left) and 17 August, 2021 (right)



Figure 3. Before forest fire in Marmaris area



Figure 4. After forest fire in Marmaris (left) and Köyceğiz (right) areas

## Full-Paper Oral Presentations

### 2.2. Dataset

It was decided to use Marmaris data as training data while Köyceğiz data as test data. The larger the data set, the better the learning. In order to increase the accuracy of the model, the data obtained was fragmented and the number of data was made more meaningful. There are two folders named test and train in the dataset. There were 175 data in the test folder and 327 data in the train folder. The Figure 5 shows the distribution ratios of training and test data.

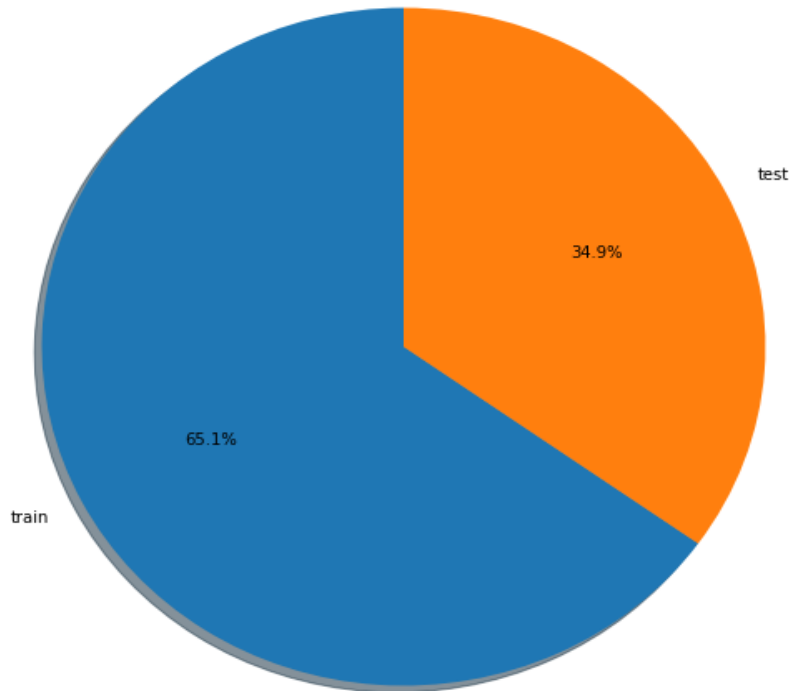

Figure 5. Train and test data distribution

### 2.3. PyTorch

PyTorch is a rapidly developing and preferred deep learning library. PyTorch was published by Facebook in 2017 as a Python-based and open-source machine learning library connected to Torch. It also uses different servers for CPU and GPU without acting on a single server. With the use of dynamic computational graphics, it becomes very easy to adapt to the changing amounts in the input data. The selection of the Pytorch library in the study was effective because it allowed the creation of neural network models. (Sen and Sawant, 2021).

### 2.4. AlexNet

Deep learning architectures, which have become more competitive with the ImageNet competition, are increasing more and more with the number of layers and success rates that change every year (Aliyu et al., 2020). AlexNet architecture came first in this competition, which standardized on deep neural networks, with a success of 83.6% (Krizhevsky et al.,



## Full-Paper Oral Presentations

2012). This was the first study to make convolutional neural network models and deep learning popular again (Karakurt and İşeri, 2022). The use of ReLU instead of the hyperbolic tangent activation function in the AlexNet architecture has made it one of the most preferred architectures today.

There are 5 basic convolution layers in the AlexNet deep learning network, which consists of 25 layers. Generally, an activation layer, the relu layer, is used after each convolution layer. In addition, there are input layer, normalization layer, pooling layer, dropout layer, fully-connected layer, soft-connected layer and output layer (Doğan and Türkoğlu, 2019). The AlexNet architecture was designed to classify 1000 objects and the error rate in object identification was reduced from 26.2% to 15.3%. The deep learning algorithm provided an accuracy rate of 80% (Doğan, 2018). Figure 6 shows the AlexNet architecture.

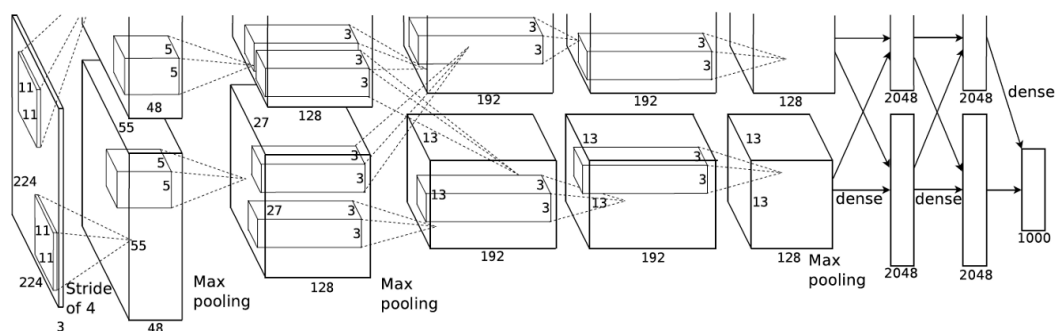

Figure 6. AlexNet architecture

In architecture, it is seen that the problem is divided into two parts, half of which runs on GPU1 and the other half on GPU2. This keeps the communication load low, which helps to achieve good overall performance. Data processing from two channels is crossed only in the third feature extraction layer. In this multi-layered structure, each layer must transfer the data to the next layer after performing its own operation. While the input data is transferred within the network, the amount of data between the layers is quite high. Therefore, the input image size becomes 55x55x48 due to its division by 2 GPUs. Other layers proceed in the same way. In the sixth layer, the input is converted to a vector and multiplied by 2048. It takes quite a while to execute transactions with a normal processor. GPUs are used to reduce this processing time and to perform more operations at the same time (Doğan and Türkoğlu, 2019).

## 2.5. Hyperparameters

In machine learning, hyperparameter is a parameter whose value is used to control the learning process. While designing machine learning models that learn from data, the algorithms or techniques used in the model bring some parameters that the designer should decide on. In contrast, the values of other parameters are derived through training. Solving problems with deep learning has become equivalent to designing the multi-layered network structure in the

### Full-Paper Oral Presentations

best and optimum way. In this engineering, after the intuition of the researcher, the most frequently used tools have been hyperparameters. There may be different hyperparameter groups where the model provides high performance (Lee et al., 2022).

Optimization methods are used to find the optimum value in the solution of nonlinear problems. Optimization algorithms such as stochastic gradient descent, adagrad, adadelta, adam, adamax are widely used in deep learning applications. The Adam optimizer was used for optimization in the model and the model was compiled in this way. Adam is an adaptive learning rate optimization algorithm designed specifically for training deep neural networks. The algorithms leverage the power of adaptive learning rates methods to find individual learning rates for each parameter.

Learning rate can be the most important hyperparameter when configuring your neural network. The default value for learning rate is usually 0.01 and it is reduced to 0.001 after a certain epoch. In this study, the learning rate was defined as 0.001. Before the training, the data were matrixized and visualized randomly as seen in the Figure 7.

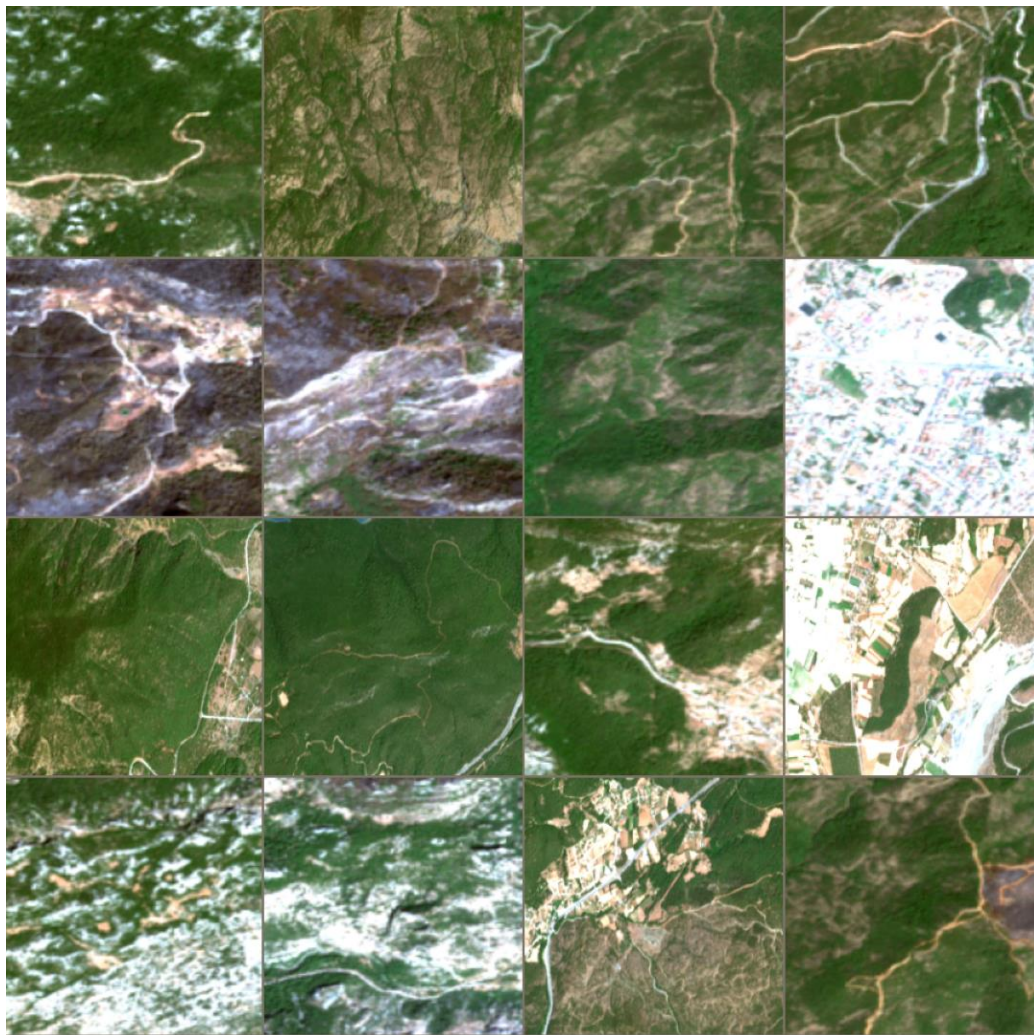

Figure 7. Image matrix

**Full-Paper Oral Presentations**

While the model was being trained, not all of the data are included in the training at the same time. They took part in education in a certain number of parts. The first piece was trained, the performance of the model was tested, and the weights were updated with backpropagation according to the success. In the backpropagation process, this update was done by finding the difference by using backward derivatives called "chain rule" and multiplying the difference value with the "learning rate" parameter, subtracting the result from the weight values and calculating the new weight value. Then the model was retrained with the new training set and the weights were updated again. This process was repeated at each training step to try to calculate the most appropriate weight values for the model. Each of these training steps was called an "epoch". Since the most suitable weight values to solve the problem in deep learning were calculated step by step, the accuracy would be low in the first epochs, and the accuracy increase as the number of epochs increases. The number of epochs varies according to the training. As the accuracy increases visibly with each step, this increase starts to increase by decreasing and stabilizing at a certain rate. In this case, the training can be terminated. The epoch number was determined as 50 in this study. After the training, the test phase of the model was visualized as in the Figure 8 and its performance was checked.

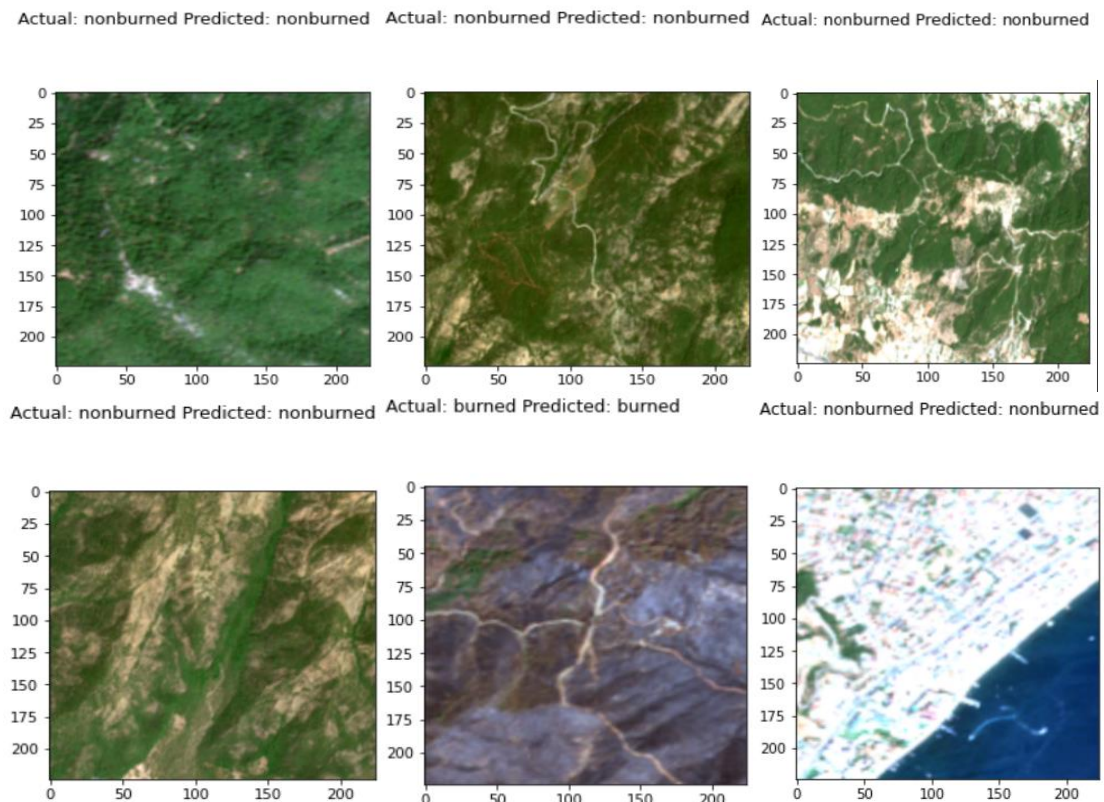

Figure 8. Test for training

**3. Results and Discussion**

Figure 9 contains four different combinations of predicted and actual values. In the confusion matrix, there are some terms we need to define. These were used to calculate various metrics.

**Full-Paper Oral Presentations**

TP (True positive): burnt means burnt (I)

FP (False positive): unburned means burnt (II)

TN (True negative): unburned means unburned (III)

FN (False negative): burnt means not burn (IV)

		Actual Values	
		Positive (1)	Negative (0)
Predicted Values	Positive (1)	TP	FP
	Negative (0)	FN	TN

Figure 9. Confusion matrix table

Figure 10 is the classification of the burned and unburned areas of the complex matrix. It can be seen that the model created was able to correctly predict 19 of the 21 unburned areas, while it could correctly predict 76 of the 77 burned areas. In this way we can explain the performance of our model from the complexity matrix.

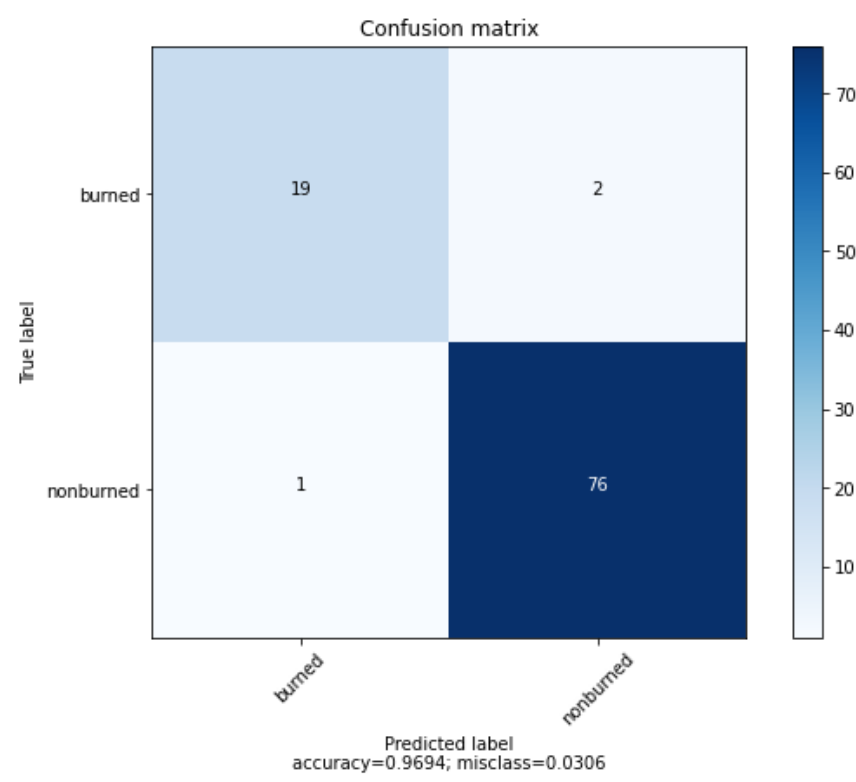

Figure 10. Result of matrix

### Full-Paper Oral Presentations

The metric is a function used to evaluate the performance of your model. Metric functions are like loss functions, except that the results from the evaluation of a metric are not used when training the model. Any loss function can also be used as a metric (Aliyu et al., 2020). In the study, loss function, F1score, Accuracy, Recall, Precision metrics were evaluated and analyzed. The formulas of the metrics are given in the Table 1.

Table 1. Formulas of metrics

Metric	Formula and Description
True Positive Rates (TPR)	$TPR = TP / (TP + FN)$
False Positive Rates (FPR)	$FPR = FP / (FP + TN)$
Precision	$Precision = TP / (TP + FP)$
Recall	$Recall = TP / (TP + FN)$
F-Measure	$F-Measure = 2TP / (2TP + FP + FN)$
Accuracy	$Accuracy = (TP + TN) / (TP + TN + FP + FN)$

In this study, the performance of the AlexNet network model was evaluated using the Pytorch library and Python programming language on a machine with NVIDIA GPU processor on the Google Colab platform. Experimental results using the AlexNet network model to train different number of forest image datasets show that the classification accuracy decreases as the number of datasets decreases (Zhu et al., 2018).

The architecture was retrained and tested for each hyperparameter. When the number of training rounds was determined as 20 in the first trial, it was observed that the study was not significant. With the increased data, the number of training tours has been updated to 50. In addition, ReLU was used in the hidden layers and the sigmoid function was used in the fully connected layer. F1 score value of 0.9794, accuracy value of 0.9694, recall value of 0.9896, and precision value of 0.9694, which were used to measure the success of the model and were desired to be close to 1, were obtained (Figure 11).

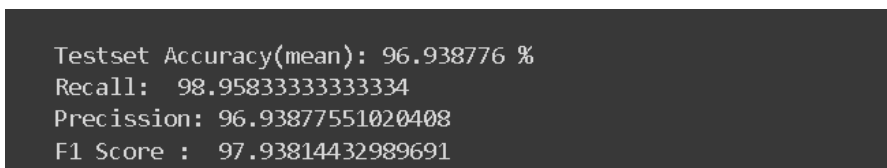

Figure 11. Test results

#### 4. Conclusions

Forest fires can cause detrimental effects on forest ecosystems and threaten human life. To fight against forest fires, fire severity damaged should be accurately determined and so that prevention plans can be developed. CNN, commonly used method in deep learning applications, was employed for classification of fire damaged forest areas. The high accuracy, F1 score, sensitivity and recall values obtained showed that the CNN model proposed in this study can be used in the classification of forest fire images. In future studies, more successful architectures can be obtained by setting hyper-parameter values differently. In addition, it is predicted that deep learning architectures can be used successfully to fight forest fires.

**Full-Paper Oral Presentations****References**

- Aliyu, H. A., Razak, M. A. A., Sudirman, R., Ramli, N. 2020. A deep learning alexnet model for classification of red blood cells in sickle cell anemia. *IAES International Journal of Artificial Intelligence*, 9(2): 221–228. <https://doi.org/10.11591/ijai.v9.i2.pp221-228>
- Bayat, O., Aljawarneh, S., Carlak, H.F. 2017. Proceedings of 2017 International Conference on Engineering & Technology (ICET'2017): Akdeniz University, Antalya, Turkiye, 21-2.
- Doğan, F., Türkoğlu, İ. 2019. Derin Öğrenme Modelleri ve Uygulama Alanlarına İlişkin Bir Derleme. *DÜMF Mühendislik Dergisi*, 10(2):409–445. <https://doi.org/10.24012/dumf.411130>
- Fidanboy, M., Adar, N., Okyay, S. 2022. Development of a forest fire prediction model based on deep learning and forecast fire risk map of Turkey. *Turkish Journal of Forestry Research*, 2022(2):206–218. <https://doi.org/10.17568/ogmoad>
- Karakurt, M., İşeri, İ. 2022. Patoloji Görüntülerinin Derin Öğrenme Yöntemleri İle Sınıflandırılması. *European Journal of Science and Technology*. <https://doi.org/10.31590/ejosat.1011091>
- Krizhevsky, A., Sutskever, I., Hinton, G.E. 2012. Imagenet classification with deep convolutional neural networks. *Advances in neural information processing systems*, 1097-1105.
- Lee, C., Park, S., Kim, T., Liu, S., Md Reba, M. N., Oh, J., Han, Y. 2022. Machine Learning-Based Forest Burned Area Detection with Various Input Variables: A Case Study of South Korea. *Applied Sciences (Switzerland)*, 12(19). <https://doi.org/10.3390/app121910077>
- Ferdi, D. 2018. The Comparison Of Leaf Classification Performance Of Deep Learning Algorithms. In *Sakarya University Journal Of Computer And Information Sciences (Vol. 1)*.
- Polat, N., Kaya, Y. 2021. Çok Bantlı Uydu Görüntüleriyle Orman Yangınlarının Belirlenmesi ve Hasar Tespiti. *Bartın Orman Fakültesi Dergisi*, 23(1). <https://doi.org/10.24011/barofd.837507>
- Sen, S., Sawant, K. 2021. Face mask detection for covid\_19 pandemic using pytorch in deep learning. *IOP Conference Series: Materials Science and Engineering*, 1070(1): 012061. <https://doi.org/10.1088/1757-899x/1070/1/012061>
- Yılmaz, O., Aydın, H., Çetinkaya, A. 2020. Faster R-CNN Üzerinde Geliştirilen Model ile Object Detection Api Üzerinde Doğruluk Tahmini ve Analizi. *European Journal of Science and Technology*. <https://doi.org/10.31590/ejosat.753896>
- Zhu, L., Li, Z., Li, C., Wu, J., & Yue, J. (2018). High performance vegetable classification from images based on AlexNet deep learning model. *International Journal of Agricultural and Biological Engineering*, 11(4), 190–196. <https://doi.org/10.25165/j.ijabe.20181104.2690>

**Full-Paper Oral Presentations****The Importance of Realtime Scanning Radars in Determining Flood Levels: The Case of the Kastamonu - Bozkurt Flood in June, 2022****Çiğdem Özer Genç<sup>\*</sup>, Arif Oguz Altunel**

Kastamonu University, Faculty of Forestry, Department of Forest Engineering, Kastamonu, Turkiye)

<sup>\*</sup> [cozer@kastamonu.edu.tr](mailto:cozer@kastamonu.edu.tr)**Abstract**

Floods and overflows, which pose serious problems for humanity in the world, frequently occur in Turkiye and can cause catastrophic results. It has been determined that the total number of floods that occurred in our country between the years 2010-2021 is 2486. One of the most important practices that should be done in order to prevent the flood hazards and to reduce the damages will be the creation of flood forecasting and early warning systems by monitoring the precipitation levels. Precipitation is a parameter with significant spatial and temporal variability. Weather forecasting Doppler radars are among the commonly used installations to determine precipitation intensity. Since these radars have high temporal and spatial resolution, they have the feature of providing robust and reliable data by following atmospheric anomalies that occur as a result of meteorological events. In this study, the flood disaster that occurred in Kastamonu-Bozkurt sub-district in the western Black Sea region of Turkiye on 27.06.2022 will be examined. Within the scope of the study, Radar images acquired by doppler radars in Zonguldak will be used to produce precipitation intensity map for the sub-district. They will be critical assets for disaster preparedness scenarios.

**Keywords:** *Disaster, Flood, Realtime Scanning Radars, Precipitations Intensity***1. Introduction**

Natural disasters cause property damage and jeopardize human life especially in urban areas (Linsley, 1986). In the last 20 years (between 1998 and 2017), 7255 natural disasters such as floods, storms, landslides, earthquakes, droughts, fires, extreme temperatures and volcanic eruptions have been recorded in the world. Among these natural disasters, the flood was the most frequently occurring one with 43.4% (3148) (Mizutori, and Guha-Sapir, 2017; Ceylan and Kömüşçü, 2007; Ersoy et al., 2017). They are the events causing the most life and economic losses among the natural disasters. It has been determined that the total number of floods that occurred in our country between the years 2010-2021 was 2486 (URL 1).

Flood is the event that streams, rivers and impact areas are filled with water at certain rates due to natural or different factors (Zeybek, 2009). Human activities have important effects on the formation of these damages, and the following five main factors are more effective. Weather events, landforms, soil characteristics, vegetation and human are those factors that affect the formation of flood (Özcan, 2006; Avcı and Sunkar, 2018). In this context, positive factors such as sufficient stream or creek branches to effectively carry the precipitation

## Full-Paper Oral Presentations

falling in the region, infiltration capacity of the surrounding soils, forest areas' water holding ability, and suitable planned settlements will reduce the flood formation (AFAD, 2022).

In our country, there are regions with a very high-risk rate in terms of floods and overflows in terms of topography (Bahtiyar and Şahtiyancı, 2020) (Figure 1). Precipitation falling in these regions rapidly flows depending on the topographic, soil structure and amount of precipitation, and may cause floods and overflows. Therefore, it is important to use meteorological radars in order to create early warning systems that can detect the amount of precipitation that may fall in risky areas in terms of floods and overflows and predict the events that may occur as a result of these precipitations (Kömüşcü 2020; Sunkar and Toprak, 2016; Özcan, 2006).

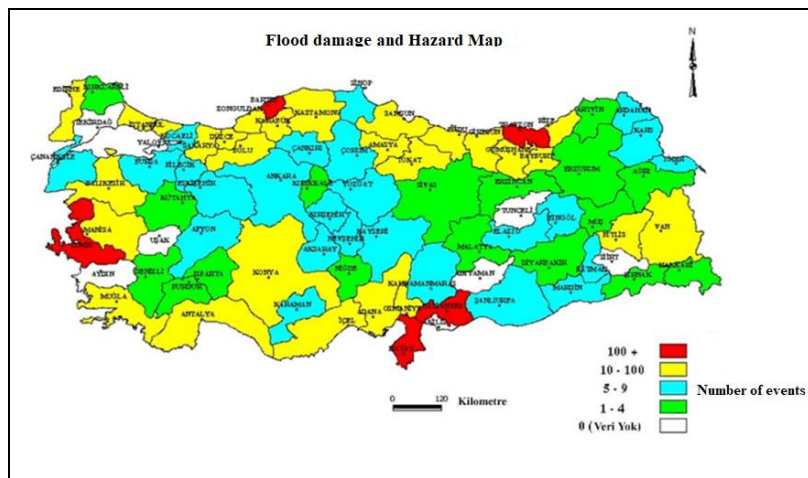

Figure 1. Türkiye flood damage and hazard map (URL 2)

In this study, the flood disaster that occurred in Kastamonu-Bozkurt sub-district in the western Black Sea region of Türkiye in 27.06.2022 will be examined. Within the scope of the study, radar images acquired by one of the Doppler radars in Zonguldak will be used to produce precipitation intensity map for the sub-district. They will be critical assets for disaster preparedness scenarios.

## 2. Doppler Radars

Doppler radars can measure the shift between the transmitted signal frequency and the signal reflected from the objects. Radars have been able to predict particularly heavy rains, hail, tornadoes, floods and floods. With meteorological radars, which are an active remote sensing system, the location, speed and direction of movement of the meteorological event can be determined, and information about the type, severity and amount of the it can be obtained. When the electromagnetic signal sent from the radar comes into contact with hydrometeors such as raindrops, snowflakes, and hail, it is exposed to electromagnetic scattering. These scattered electromagnetic waves are detected and processed by the sensitive receivers of the radars and presented to the user as a visual product through software (URL 3). Doppler radar measures precipitation and radial speeds of wind over large areas in real time. Also, the radar's ability to see the movement of the echo is very useful in forecasting short-term precipitation (URL 3).



**Full-Paper Oral Presentations**

There are a total of 18 radars used operationally in our country (Figure 2). The coverage area of each radar can be up to 370 km in scanning mode and up to 120 km radius in Doppler mode. A full scanning period of these weather radars is usually 6 minutes and they have a spatial resolution of 125 meters. The energy of the reflected rays is proportional to the size of the raindrops and therefore to the intensity of the precipitation. Radar can be particularly useful in determining the local distribution of precipitation (Chandrasekar et al., 2003).

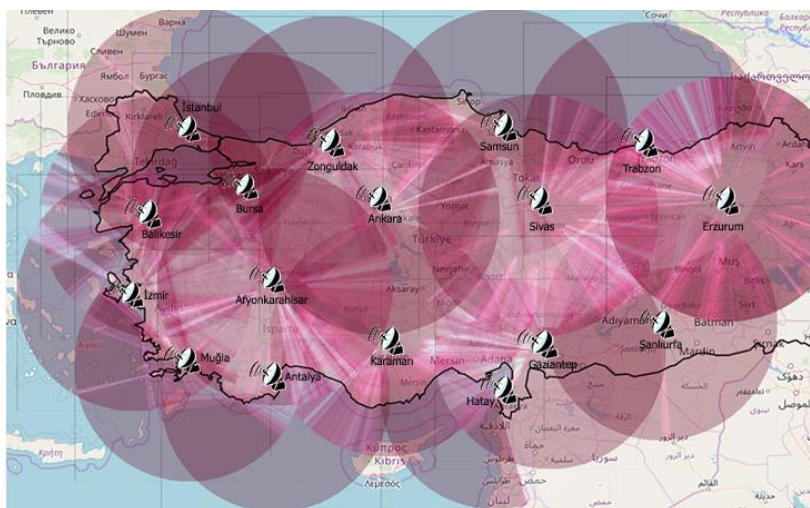

Figure 2. Number and areas scanned of radars in our country

**3. Determining the precipitation amount of the flood in Bozkurt with Doppler radars**

In this study, the flood disaster that occurred in Kastamonu-Bozkurt sub-district in the western Black Sea region of Turkiye on 27.06.2022 was examined (Figure 3).

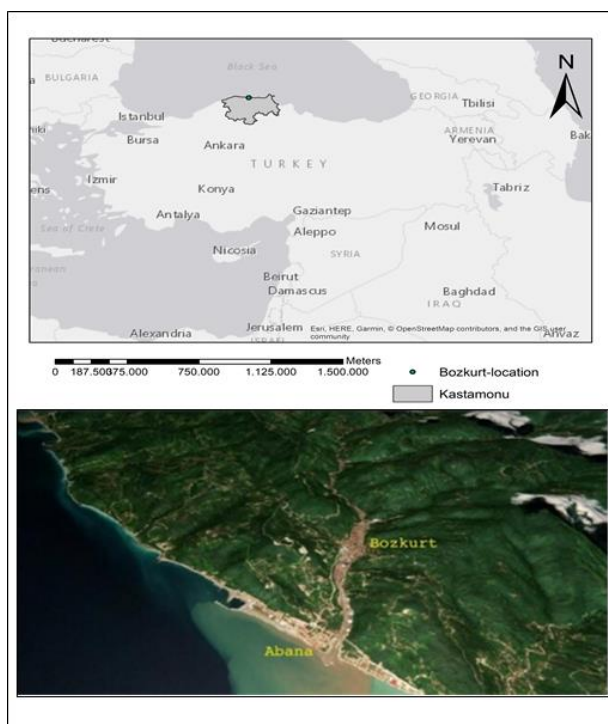

Figure 3. Kastamonu-Bozkurt location where the flood occurred

**Full-Paper Oral Presentations**

In the study, the precipitation intensity was tried to be determined with the data obtained from the Doppler radar in Zonguldak. The radar works with horizontal scanning in the c-band within a horizontal radius of 250 km (Figure 4). In the study, emitted radar signals and return signals were evaluated. Radar continuously scans the area at 6-minute intervals. The accumulation of these scans constitutes first hourly, then daily raw data. Hourly averages were processed over 362 x 362 m raster cells. One-day data from the day of the flood was used. Then, geographically projected and “hdf5” formatted radar image was converted to "tiff" format and reprojected to UTM using ArcGIS 10.5, and raster data were downsized to sub-basins which had previously been generated from a DEM produced from 1:25000 scaled national quads. Then, a GRID spaced at 362 m and later turned into points was laid over the precipitation image. Subsequently, hourly precipitation totals were appended onto these points (Figure 5, Figure 6).

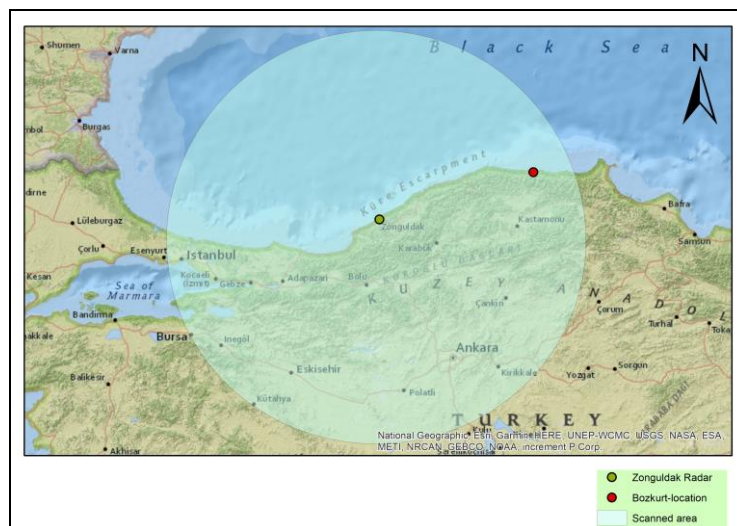

Figure 4. The radar-scanned area and the Zonguldak location

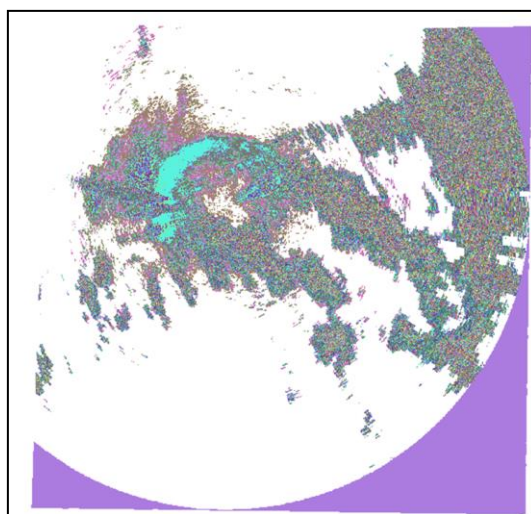

Figure 5. Zonguldak radar image

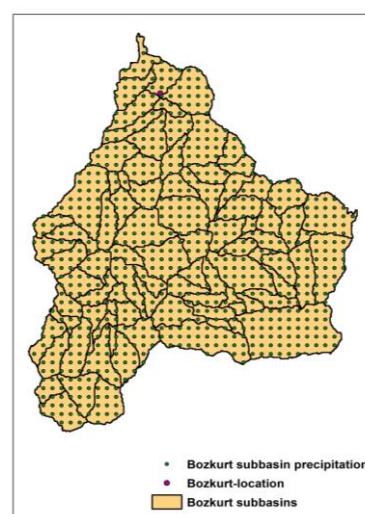

Figure 6. Grid points from which precipitation data are falled

### Full-Paper Oral Presentations

As a result of the evaluation of one-day data, it was determined that the amount of precipitation reaching Bozkurt sub-district was 39 mm.

#### 4. Results and Suggestions

In this study, the importance of meteorological radars in the detection and follow-up of natural disasters is emphasized and the determination of the amount of heavy precipitation in Kastamonu-Bozkurt using radar is explained.

The ability to measure weather events occurring in the atmosphere in high resolution and real time, quickly and frequently, using radars contributes to meteorological studies as it provides rather sensitive data. Despite the factors that negatively affect the data quality, radars appear as an important data source in the evaluation of various atmospheric events and speed measurements related to atmospheric movements, as well as obtaining precipitation information.

Thus, it will be possible to provide early warning information with radar systems in order to minimize the loss of property and life as a result of natural disasters of various meteorological origins in our country and world.

#### References

- AFAD, 2022. <https://www.afad.gov.tr/afadem/sel>
- Avcı, V. ve Sunkar, M. 2018. Bulancak'ta (Giresun) sel ve taşkın olaylarına neden olan Pazarsuyu, İncüvez, Kara ve Bulancak derelerinin morfometrik analizleri. *Fırat Üniversitesi Sosyal Bilimler Dergisi*, 28(2), 15-41.
- Bayraktar, H., and Sahtiyancı, E. 2020. 17-18 Temmuz 2019 Akçakoca ve Cumayeri (Düzce) Sel Afeti Sonuçları ve Müdahale Çalışmaları. *Resilience*, 4(2), 239-255.
- Ceylan, A. and Kömüşçü, A. Ü. 2007. Meteorolojik karakterli doğal afetlerin uzun yıllar ve mevsimsel dağılımları. *İklim Değişikliği ve Çevre*, 1(1), 1-10.
- Chandrasekar, V., Meneghini, R., Zawadzki, I. 2003. Global and local precipitation measurements by radar. In *Radar and atmospheric science: a collection of essays in Honor of David Atlas* (pp. 215-236). American Meteorological Society, Boston, MA.
- Ersoy, Ş., Nurlu, M., Gökçe, O., Özmen, B. 2017. 2016 Yılında Dünyada ve Türkiye'de Meydana Gelen Doğa Kaynaklı Afet Kayıplarının İstatistiksel Değerlendirmesi. *Mavi gezegen*, (22).
- Kömüşçü, A. U., Aksoy, M., Çelik, S., Ciba, Ö. F., Uğurlu, A., Turgı, E., Emel, Ü.nal. (22). 22 Ağustos 2020 Tarihinde Giresun ve İlçelerinde Meydana Gelen Şiddetli Yağış ve Sel Olayının Meteorolojik ve Hidrometeorolojik Analizi. *Su Kaynakları*, 6(1), 1-14.
- Linsley, R. K. 1986. Flood estimates: how good are they?. *Water Resources Research*, 22(9S), 159S-164S.
- Mizutori, M., and Guha-Sapir, D. 2017. Economic losses, poverty and disasters 1998–2017. *United Nations Office for Disaster Risk Reduction*, 4, 9-15.u
- Özcan, E. 2006. Sel olayı ve Türkiye. *Gazi Üniversitesi Gazi Eğitim Fakültesi Dergisi*, 26(1), 35-50.
- Sunkar, M., Toprak, A. 2016. Sel ve Taşkın Çalışmalarında Tarihi Veri Kaynaklarının Önemi. TÜCAUM Uluslararası Coğrafya Sempozyumu . Ankara.
- URL 1. 2022. Meteoroloji Genel Müdürlüğü. <https://www.mgm.gov.tr/genel/raporlar.aspx>
- URL 2. 2022. <https://www.msxllabs.org/forum/cevaplanmis/286842-ulkemizde-sel-felaketi-en-cok-hangi-bolge-de-yananmistir.html>.

**Full-Paper Oral Presentations**

URL 3. 2022. Meteoroloji Genel Müdürlüğü, 2022.  
<https://www.mgm.gov.tr/genel/meteorolojiradarlari.aspx>  
Zeybek, H. İ. 2009. 2-3 Mart 2005 Turhal Sel Afeti ve Sonuçları. *Doğu Coğrafya Dergisi*,  
(21), 233-247.

**Full-Paper Oral Presentations****Study of the Clearing Limit of Road Considering Features of Different Environmental Units in a Deciduous Forest****Aidin Parsakhoo<sup>1</sup>, Mohsen Mostafa<sup>\*2</sup>**<sup>1</sup>Department of Forestry, Faculty of Forest Science, Gorgan University of Agricultural Sciences and Natural Resources, Gorgan, Iran.<sup>2</sup>Mazandaran Agricultural and Natural Resources Research and Education Center, AREEO, Sari, Iran, [mohsenmstf@gmail.com](mailto:mohsenmstf@gmail.com), [m.mostafa@areeo.ac.ir](mailto:m.mostafa@areeo.ac.ir)**Abstract**

Clearing limit is the strip width of a forest which trees are felled for road construction. This study was conducted in a deciduous forest to determine the mean clearing limit of forest road considering different environmental units. The map of three environmental units was initially produced in GIS with considering slope steepness, geology, and slope direction, soil and forest stock growth. Then, transects on a straight road was randomly selected in each of environmental units and some cross sectional variables of clearing limit including horizontal distance from tree on slope to top of cutslope, width of the cutslope, width of the roadbed, width of the canopy gap and horizontal distance from tree stem on fillslope to road edge were measured. Results showed that the average distance between crowns in winter season was 5.2 m. Width of the cutslope in environmental unit II was more than all other environmental units, but no significant difference was detected between the environmental unit I and III regarding width of the cutslope. The mean clearing limit in environmental unit I, II and III were 11.8, 18 and 16.5 meter, respectively. Moreover, width of clearing limit increased with increasing hillside slope. Finally, corrected clearing limit was recommended for each environmental unit which can be used for same units.

**Key words:** *Clearing limit, Forest road, Environmental units, GIS, Shast Kalate district.*

**1. Introduction**

Clearing limit is the strip width of a forest which trees are felled for road construction. The width of this strip is depending on hillside slope, soil and geological properties, traffic volume and road type (Tunay and Melemez, 2004; Watkins et al., 2003). One of the negative effects of roads is the loss of forest area due to their construction. Indeed, increasing the clearing limit of forest road increases the amount of environmental damages (Haarlas, 1973; Sorkhi et al., 2012). Laurance et al. (2004) found that even roads with narrow clearing limit and low traffic volumes can reduce local movement of many insectivorous birds in Amazonia.

Safety is one of the main problems of road traffic (Pentek, 2005). Drivers' behaviour is highly dependent on the width of clearing limit especially on horizontal curves (Zakowska, 1997; Wemple et al., 2001). Different methods are used to determine the clearing limit of a forest road before earthworking operation. In fixed method a fixed width is determined for felling strip of trees and in variable method strip width is separately determined for each cross section (Sarikhani and Majnonian, 1994; Abeli et al., 2000). In first method the clearing limit may be less or more than required limit. So, more trees may be felled for road construction

## Full-Paper Oral Presentations

and if lower trees are felled unsafe traffic will occur. Second method is time consuming and expensive because of permanent controlling for construction of each cross section (LeDoux, 2004; Potočnik et al., 2005).

In recent years it was attempted to propose near to nature methods to decrease negative effects of clearing limit. For example, Nasiri (2011) reported that clearing limit should be carefully selected, not only to minimize the total road cost but also to reduce the environmental impact and to improve traffic safety. Parsakhoo et al. (2009) determined the optimum clearing limit of forest for road construction separately for cut and fill slope in steep slopes of Hyrcanian zone with suggestion of chart models. This method decreases the rate of trees felling and increases the forest roads safety and permanency. Potočnik et al. (2008) in a study about clearance of a forest road cross section in south-east Slovenia found that the distance between crowns is 6 m in a 15-year old forest road, 0.74m in a 35-year old road, and 0.24 m in a 50-year old road.

Using an *environmental unit* to increase independence and control in management can improve researches accuracy. *Environmental units* can integrate various *environmental* characteristics to support proper management of natural resources. Some of *environmental* characteristics are slope steepness, geology, slope direction, soil, hydrology and forest stock growth. In this study it was attempted to investigate clearing limit for forest road construction considering different environmental units of Shast Kalate district as well as to recommend a table to determine clearing limit in each environmental unit.

## 2. Material and Methods

District one in Shast Kalate forests with an area of 1713 hectares is located in Golestan province and in watershed number of 85 (36°43'27" to 36°48'6" N and 54°21'26" to 54°24'57" E). The bedrock of this forest is lime and sand stone with altitude ranging from 100 to 1000 m above sea level. The forest is mixed deciduous which has been established on brown forest soil with mostly sandstone as bedrock Clay-loam-silty texture and worn stones are spread around the region. The mean forest stock growth in the study area was 247m<sup>3</sup>ha<sup>-1</sup>. The climate of the region is Mediterranean warm and moist. The mean annual precipitation is 562 mm which the lowest is in July and August (Figure 1a).

Environmental units have homogeneous attributes. Land data can be integrated and classified based on characteristics such as slope steepness (Figure 1b), geology (Figure 1c), slope direction (Figure 1d) and stand stock growth (Figure 1e). Geology and stand stock growth maps were prepared from forestry plan manual of Shast Kalate forest. A Digital Elevation Model (DEM) was generated with 20-m resolution in Arc Map, and from surface analysis the slope direction and steepness maps were produced. Then the map of environmental units was produced from union procedure in GIS (Figure 1f).

**Full-Paper Oral Presentations**

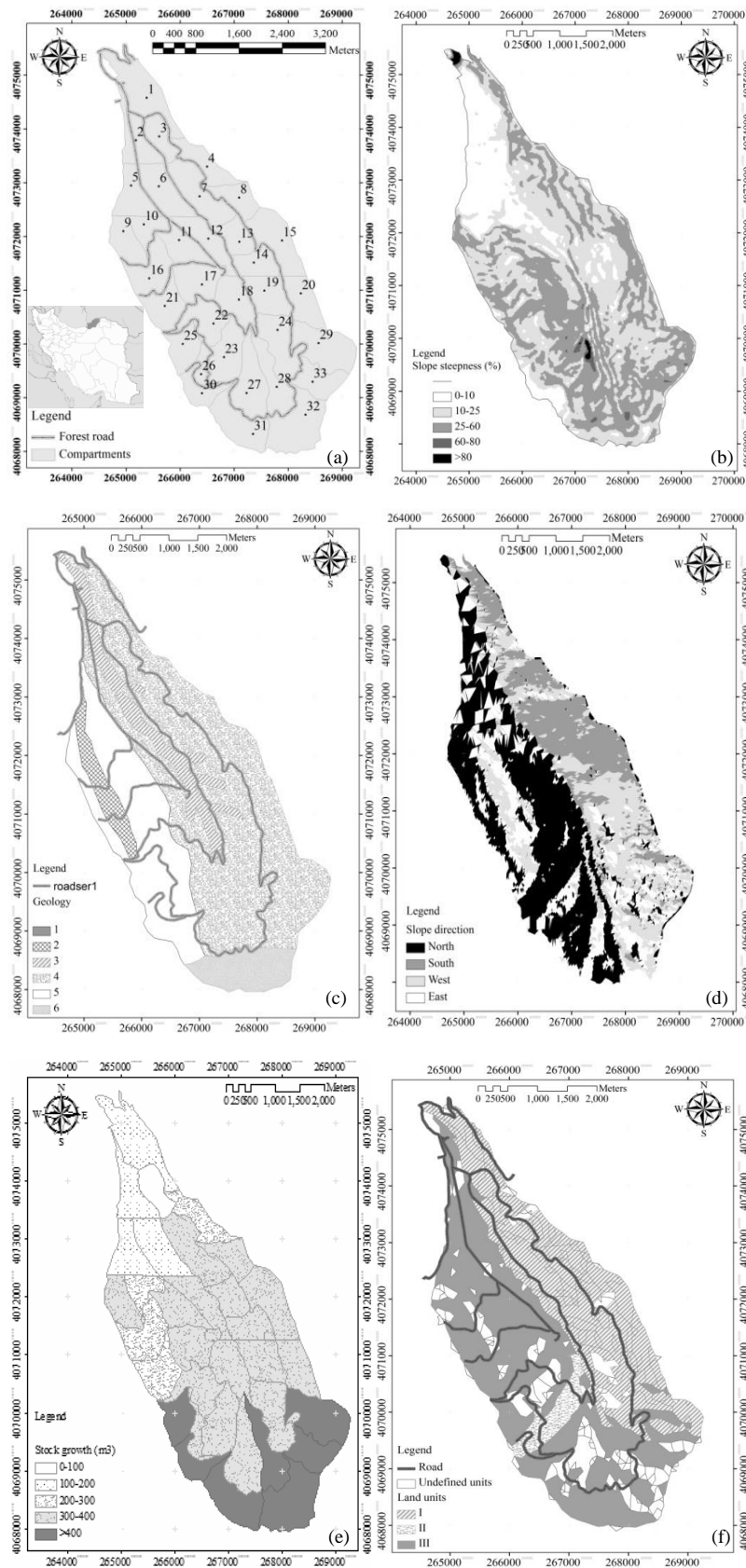

Figure 1. Study area (a) and the stages (b-f) of preparing maps of environmental units in GIS

**Full-Paper Oral Presentations**

ArcGIS version 9.2 was utilized to analysis data layers. Features of each environmental unit have been illustrated in Table 1.

Table 1. Features of environmental units in study area.

Land Units	Geology	Slope direction	Hillside slope (%)	Stock growth (m <sup>3</sup> ha <sup>-1</sup> )
I	Conglomerate sand stone	West	10-25	>300
II	Conglomerate sand stone, current age stream deposits	East	25-50	>300
III	current age stream deposits	North	0-10	100-200

In this study a straight road with a length of 1000 meter was randomly selected in each of environmental units I, II and III. 60 transects with a distance of 10 meter were vertically established on road through systematic randomized method. Hillside slope was measure by clinometer. Some cross section parameters of forest road such as horizontal distance from tree on slope to top of cutslope (A), width of the cutslope (B), width of the roadbed, width of the canopy gap and horizontal distance from tree stem on fillslope to road edge (C) were measured by tape meter (Figure 2).

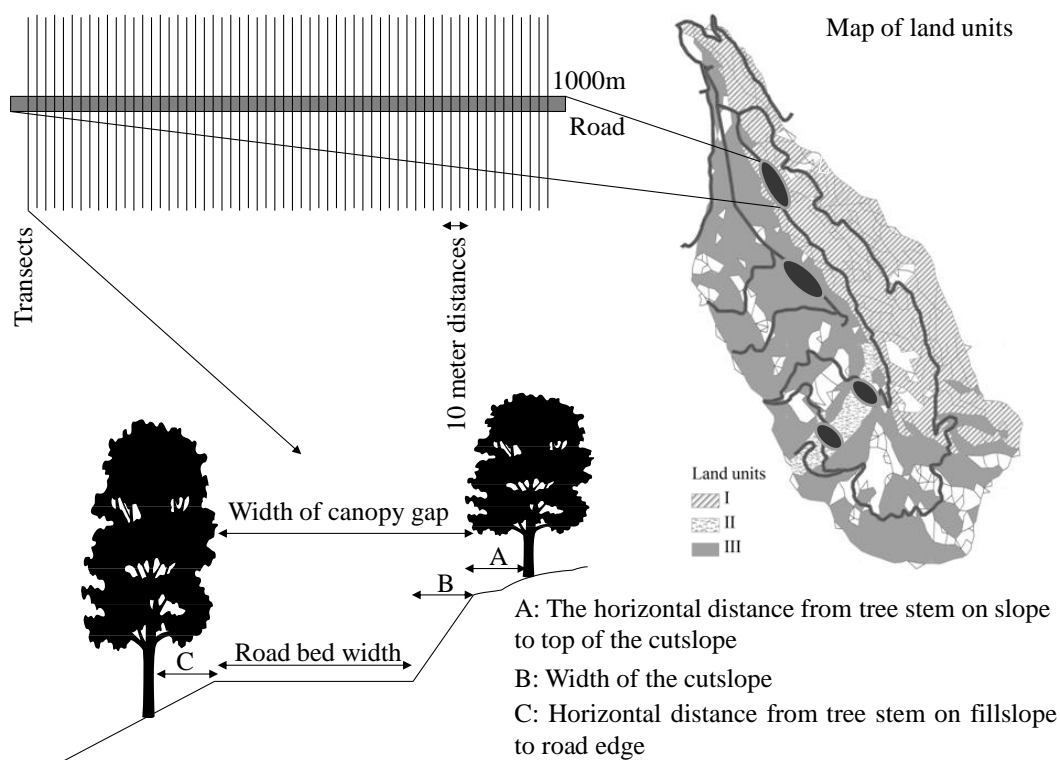

Figure 2. Sampling design for clearing limit of road in environmental units



## Full-Paper Oral Presentations

### 2.1 Statistical Analysis

Data were statistically analyzed using the GLM procedure in SAS software. SNK test (Student Newman Kolus) at probability level of 0.05 was used to compare means for different parameters of clearing limit for secondary forest road. Spearman correlation coefficient was used to determine the relationships among parameters.

### 3. Results and Discussion

In this study the width of roadbed was equal to 5.5 meter which was recorded for secondary forest road. The horizontal distance from tree on slope to top of cutslope in environmental unit III was significantly lower than all other environmental units (Figure 3a). Besides, the horizontal distance from tree stem on fillslope to road edge in environmental unit III was significantly lower than those of environmental units I and II. No significant difference ( $P>0.05$ ) was found between the environmental unit I and II in term of horizontal distance from tree stem on fillslope to road edge (Figure 3b). These detections indicate a lower canopy gap in environmental unit III. The average distance between crowns in winter season was 5.2 m (Figure 3c). Petkovic et al. (2014) for a single lane road in European beech and sessile oak forest at north of the Republic of Srpska and Bosnia and Herzegovina showed that the average distance between crowns is 5.6 m. They reported that clearing width of forest roads depends on terrain and site conditions, frequency of maintenance of forest roads, distance between forest road sections and public road, and traffic load. The distance between tree crowns is smaller in the road sections that are further away from the public roads. Width of the cutslope in environmental unit II was more than all other environmental units, but no significant difference ( $P>0.05$ ) was detected between the environmental unit I and III regarding width of the cutslope (Figure 3d).

The mean clearing limit in environmental unit III was 11.8 meter which was significantly lower than those of environmental units I and II ( $P<0.05$ ). Forest stock growth in this unit is 100-200  $\text{m}^3 \text{ha}^{-1}$ , so it was attempted to fell trees discreetly (Table 1). Maximum clearing limit was recorded in environmental unit II with 18 meters in width. The main reason of this finding is high steepness of hillside in this environmental unit (Figure 4).

Hillside slope in environmental unit II was 25-50% which was more than that of environmental units I and III (Table 1). Narrow (<20m width) clearing of road being less vulnerable to edge disturbance than are wider clearings. Beside linear clearings parallel to the path of the sun are exposed to sunlight throughout the day and can be more vulnerable to edge disturbance (Laurance et al., 2009). Sedlak (1985) stated that standard clearing limit of forest road for slope classes 30-40, 40-50, 50-60 and 60-70%, are 11, 13, 15 and 19 m, respectively.

Correlation analysis showed that there was significant positive correlation between the width of cutslope and hillside slope as well as clearing limit of road and hillside slope. Indeed, width of cutslope and clearing limit increased with increasing hillside slope. Moreover, horizontal distance from tree stem on fillslope to road edge increased with increasing hillside slope. Totally clearing limit of a forest road increases with increasing horizontal distance from tree on slope to top of cutslope, width of the cutslope, width of the roadbed and width of the canopy gap and horizontal distance from tree stem on fillslope to road edge (Table 2).

**Full-Paper Oral Presentations**

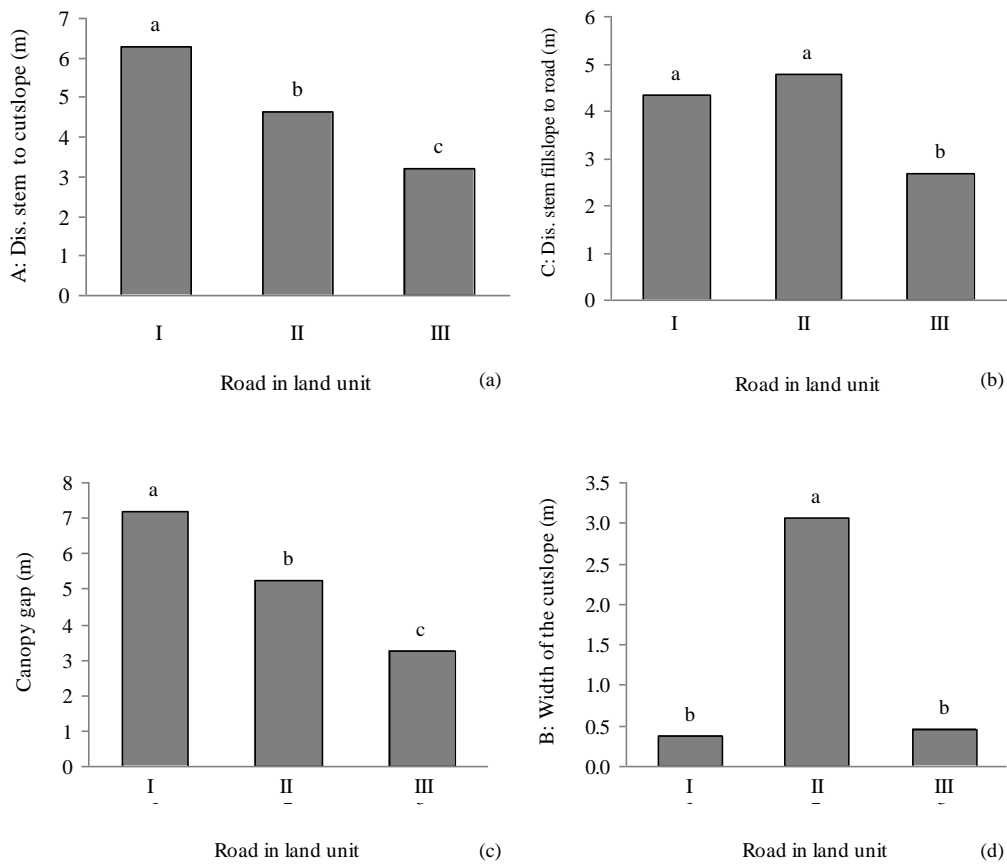

Figure 3. Comparison of the cross-sectional variables of clearing limit in different environmental units (Different letters show significant difference at  $p < 0.05$  in SNK text)

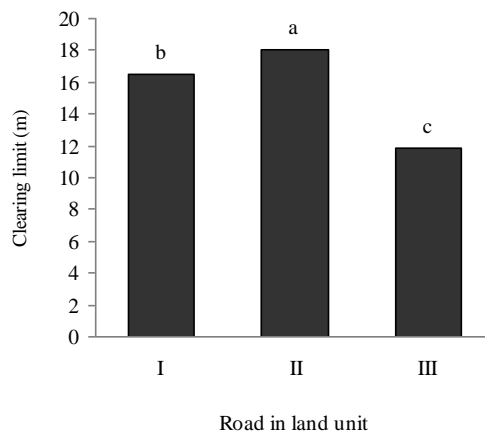

Figure 4. Comparison of the clearing limit in different environmental units (Different letters show significant difference at  $p < 0.05$  in SNK text)

**Full-Paper Oral Presentations**

Table 2. Spearman correlation coefficients between slope steepness and parameters of clearing limit.

Parameters	Slope	B	A	C	Canopy gap	Clearing limit
Slope	1.00	0.92***	-0.05	0.17*	0.03	0.32***
B	0.92***	1.00	-0.01	0.16*	0.05	0.39***
A	-0.05	-0.01	1.00	0.11	0.56***	0.70***
C	0.17	0.16	0.11	1.00	0.49***	0.63***
Canopy gap	0.03	0.05	0.56***	0.49***	1.00	0.68***
Clearing limit	0.32***	0.39***	0.70***	0.63***	0.68***	1.00

\*\*\*, \*: Significant at probability level of 0.1 and 5%, respectively. A: The horizontal distance from tree stem on hillside to top of cutslope, B: Width of cutslope, C: Horizontal distance from tree stem on fillslope to road edge

In Table 3 a corrected clearing limit is recommended for each environmental unit which can be used for same units. After the preparing this width the bothersome trees can be marked in next stages. Nasiri (2011) found that the clearing limit of valley forest road is more mountainous forest road. Presence of some pioneer species such as Alder along the forest roads can reduce clearing width (Delgado et al., 2007; Hosseini and Jalilvand 2007).

Table 3. Recommended clearing limit for each environmental unit in study area.

Land Units	Width of the roadbed (m)	B (m)	A (m)	C (m)	Total (m)
I	5.5	1.0	2.5	2.0	11
II	5.5	2.5	3.5	2.5	14
III	5.5	0.5	1.5	1.5	9

**4. Conclusion and Suggestions**

This paper proposed an approach to determine clearing limit according to feature of environmental units. It was concluded that the mean clearing limit in environmental unit I, II and III were 11.8, 18 and 16.5 meter, respectively. Forest stock growth in environmental unit III was lower than other environmental units, so it was attempted to fell trees discreetly. Maximum clearing limit was recorded in environmental unit due to high steepness of hillside. Hillside slope in environmental unit II was 25-50% which was more than that of environmental units I and III. Clearing limit of a forest road increases with increasing horizontal distance from tree on slope to top of cutslope, width of the cutslope, width of the roadbed and width of the canopy gap and horizontal distance from tree stem on fillslope to road edge. Totally, in an environmental unit with a stable geology structure, gentle slope, sunward direction such as west to south in northern hemisphere and high stock volume stands it can be possible to consider lower clearing limit.

**References**

Abeli, W.S., Shemwetta, D.T.K., Ole Melodies, R.E.L., Kachwele, M., 2000. Road alignment and gradient issues in the maintenance of logging roads in Tanzania. *International Journal of Engineering*.11 (2): 15-22.

Delgado, J.D., Arroyo, N.L., Ar'evalo, J.R., Palacios, J.M. 2007. Edge effects of roads on temperature, light, canopy cover and canopy height in laurel and pine forests (Tenerife, Canary Islands). *Landscape Urban Plan*. 81: 328-340.

**Full-Paper Oral Presentations**

- Hosseini, S.A., Jalilvand, H. 2007. Marginal effect of forest road on alder trees (Case study: Darab kola forest, mazandaran province, Iran). *Pakistan Journal of Biological Sciences*. 10: 1766-1771.
- Haarlaa, R. 1973. The effect of terrain on forest road construction. *Silva Fennica*. 7(4): 284-309.
- LeDoux, C.B. 2004. Determining safe clearing limits for skid road/trail construction, *Proceedings of the 14th Central Hardwood Forest Conference*. 148-153.
- Laurance, S.C., Stouffer, P.C., Laurance., W.F. 2004. Effects of road clearings on movement patterns of understory rainforest birds in central Amazonia. *Conservation Biology*. 18(4): 1099-1109.
- Laurance, W.F., Goosem, M., Laurance, G.W. 2009. Impacts of roads and linear clearings on tropical forests. *Trends in Ecology & Evolution*. 24(12): 659-669.
- Nasiri, M. 2011. Comparison of Right of way in Mountainous and Valley Forest Roads. *International Journal of Applied Engineering Research*. 2(2): 379-389.
- Parsakhoo, A., Hosseini, S.A., Lotfalian, M. 2009. Investigation on the forest roads right-of-way based on earthworking limit, hillside gradient and vegetative characteristics of edge stands. *Iranian Journal of forest*. 1(2): 91-104. (In Persian).
- Pentek, T. 2005. Analysis of an existing forest road network. *Croatian Journal of Forest Engineering*. 26(1): 39-50.
- Petkovic, V., Marceta, D., Potocnik, I. 2014. Horizontal and vertical alignments of forest roads. *Nova meh. Šumar*. 35: 79-87.
- Potočnik, I., Pentek, T., Pičman, D. 2005. Impact of traffic characteristics on forest roads due to forest management. *Croatian Journal of Forest Engineering*. (26)1: 51-57.
- Potočnik, I., Pentek, T., Pičman, D., Papa, I., Poje, A. 2008. Filling in the clearance of a forest road cross-section in Beech forest. *Croatian Journal of Forest Engineering*. 29 (1): 53-62.
- Sarikhani, N., Majnonian, B. 1994. Guideline for production of forest roads project. *Plan and Budget Organization Publication*. 131: 136-159.
- Sorkhi, A., Hoseini, S.A., Lotfalian, M., Parsakhoo, A. 2012. Effect of the standard clearing limit of forest road right-of-way on stand stock growth: Case study of Vaston forests, Hyrcanian zone. *African Journal of Environmental Science and Technology*. 6 (1): 43-49.
- Sedlak, O. 1985. Forest road planning, location and construction techniques on steep terrain, logging and transport in steep terrain, *FAO Forestry Paper*, FAO, Rome. 333pp.
- Tunay, M, Melemez, K. 2004. Environmental effects of forest road construction on steep slope. *CAB abstracts*. 13: 33-37.
- Watkins, R.Z., Chen, J., Pickens, J. 2003. Effects of forest roads on understory plants in a managed hardwood landscape. *Conserv. Biol*. 17: 411-419.
- Wemple, B.C., Swanson, F.J., Jones, J.A., 2001. Forest roads and geomorphic process interactions, Cascade Range, Oregon. *Earth. Surf. Process. Landform*. 26:191-204.
- Zakowska, L. 1997. Dynamic road view research for road safety and aesthetics evaluation. *Journal for Geometry and Graphics*. 1(1): 51-57.

**Full-Paper Oral Presentations****Evaluating the Effects of Forest Roads on Forest Fire Using Sentinel-2 Satellite Images – A Case Study for Cokertme Fire in Turkiye****Gizem Misirlioglu<sup>1\*</sup>, Selçuk Gümüş<sup>1</sup>**<sup>1</sup> Department of Forest Engineering, Faculty of Forest, Karadeniz Technical University, Trabzon, Turkiye  
[\\*gizemyorulmaz@ktu.edu.tr](mailto:gizemyorulmaz@ktu.edu.tr)**Abstract**

The construction of forest roads is very important in terms of putting forests into operation and providing access to forests in case of disasters. With the increase in climate change, the increase in the number of years in which the risk of fire is high, the prolongation of the fire season, and the effect of the fires on larger areas increase the importance of forest roads. In this study, the Cokertme neighborhood within the borders of the Milas Forestry Management Directorate, which was highly affected by the fire that destroyed 12764 ha of forest area in 2021, was chosen as the study area. Analyzes were made on Sentinel-2 satellite images before and after the fire in the study area. An area of 1995.35 ha where the effect of the fire was seen on these satellite images was determined as the study area. The forest cover and forest roads in this area were digitized and the situation before and after the fire was determined. While there were 50.13 km of roads in the area before the fire, the number of roads after the fire was found to be 88.85 km. The road density in the area was determined as 31.5 m/ha. Although the forest road density is higher than desired, it is concluded that the reason why the fire is so effective in the area is that the roads are not homogeneously distributed over the area.

**Keywords:** *Forest roads, Forest fire, Sentinel-2, ArcGIS, Satellite images*

**1. Introduction**

Well-planned forest roads are very important for forest protection and forest management (Gumus et al., 2008). With the increase in climate change, providing access to the forest cannot be considered only as a wood production stage. Roads should be planned to meet more than one need. Road construction should be of such a nature as to prevent environmental degradation, especially to preserve ecological impacts and biodiversity (Laschi et al., 2019).

In recent years, the relationship between forest road network and forest fire prevention and extinguishing has gained more and more importance. The insufficient amount of forest road network makes it impossible to access the forest and respond to the fire during a fire. Forest fire represents one of the most important threats to forests, forest villages and other wooded areas in many parts of the world. In addition, due to climate change, it is expected that the number of years with a high risk of fire will increase, the fire season will prolong and extreme events that may cause larger, more intense and more frequent fires will increase (Giannakopoulos et al., 2009).

Firefighting options are still considered the most important issue by fire experts in Mediterranean countries (Raftoyannis et al., 2014). At the beginning of these options, forest road network planning should be examined in order to achieve effective fire prevention and

## Full-Paper Oral Presentations

extinguishing processes (Stefanovic et al., 2015). Forest road networks contribute to guaranteeing continuous and high-quality surveillance, especially during periods of high risk. All roads can be used for surveillance of the most sensitive areas during periods of high fire risk. These roads can be periodically closed to traffic by firefighting vehicles, thus serving the dual purpose of acting as a deterrent against arsonists and allowing very rapid response should a fire start (Calvani et al., 1999). Analysis of forest road functions, planning, construction and maintenance methods is needed to achieve this goal and increase the effectiveness and efficiency of the firefighting organization.

In this study, the forest fire that occurred in the Çökertme neighborhood of the Milas Forest Management Directorate in 2021, where there was a loss of 12764 ha of forest, was discussed. The existing forest roads in the area and forest roads added during and after the fire were determined. The situation before and after the fire was analyzed through the Arcmap module of ArcGIS software. The effects of the constructed and existing roads on forest fire were tried to be determined.

## 2. Material and Methods

The Çökertme neighborhood, which was affected by the fire in 2021 between 37° 00' 28" - 27° 47' 38", within the borders of Milas Forestry Operations Directorate, was chosen as the study area. According to the 2021 Forest Fires Evaluation Report, an intentional forest fire in Milas Forest Management Directorate affected the Yalı, Mumcular, Çökertme and Ören Directorates with the effect of the strong wind and destroyed 12764 ha forest area (OGM, 2021) (Figure 1, 2).



Figure 1. Study area

(31.07.2021 - MİLAS – Karacahisar, Yalı, Mumcular, Çökertme, Ören)



(Milas - Karacahisar - Beyciler Mah. Batışderesi 12764,0 Ha.)

Figure 2. Fires in Milas Forestry Management Directorate (OGM,2021)

### Full-Paper Oral Presentations

In the evaluation report, it was stated in the first article regarding the suggestions on extinguishing that the forest roads planned in the network plan should be completed and the existing fire safety roads should be maintained, and the appropriate fire safety roads would be re-evaluated within the scope of YARDOP. With this proposal, in this study, an area highly affected by the fire in Çökertme neighborhood was determined and analyzes were made on Sentinel-2 satellite images with a resolution of 10 meters.

Two Sentinel-2 satellite images of the area were selected, with dates before and after the fire (Figure 3 and 4). Based on these satellite images, an area of 1995.35 ha affected by the fire was determined as the study area.

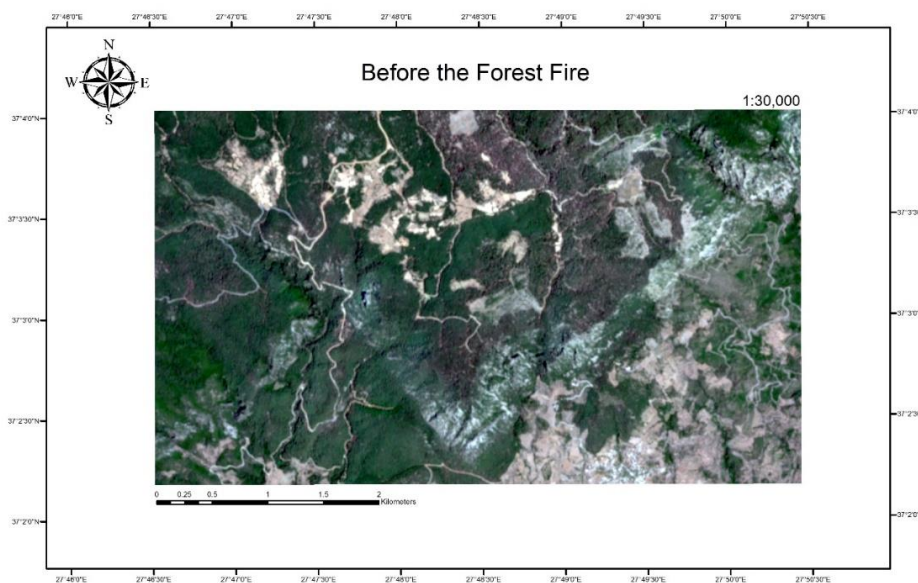

Figure 3. Situation before the forest fire

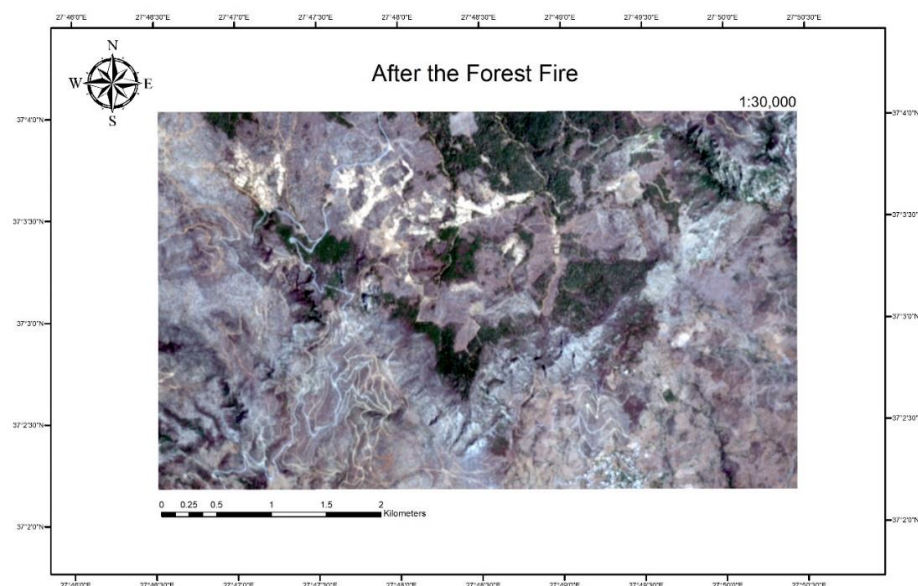

Figure 4. Situation after the forest fire

**Full-Paper Oral Presentations**

Digitizing the existing roads and forest area through the Arcmap module in ArcGIS software over these satellite images was made and the effect of the fire was tried to be determined.

**3. Result and Discussion**

The amount of roads available before the fire was determined as 50.13 km, and the amount of roads after the fire was determined as 88.85 km. In this case, there is 38.72 km of road added to the existing road. It is thought that while there may be lanes opened during the fire, roads that are not clear from the forest cover in the satellite image before the fire may also affect this amount (Figure 5, 6).

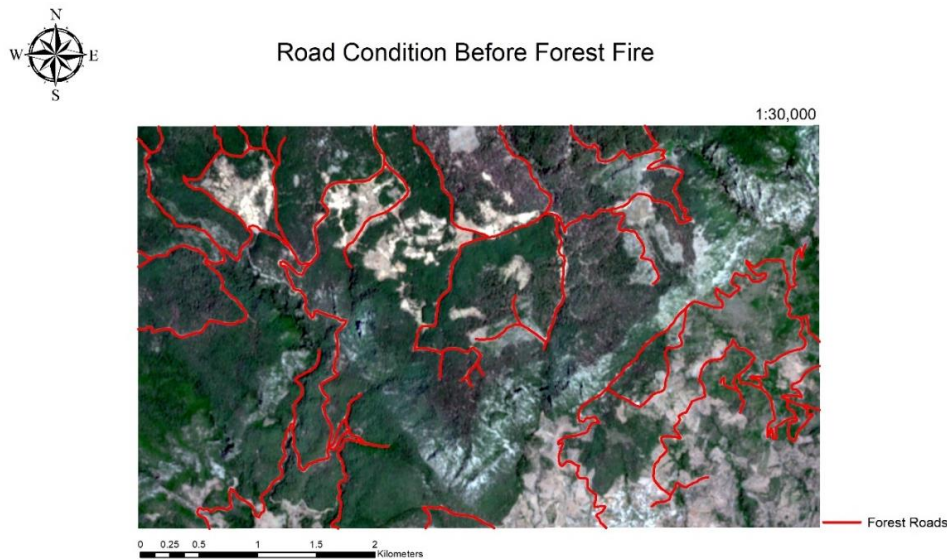

Figure 5. Road condition before the forest fire

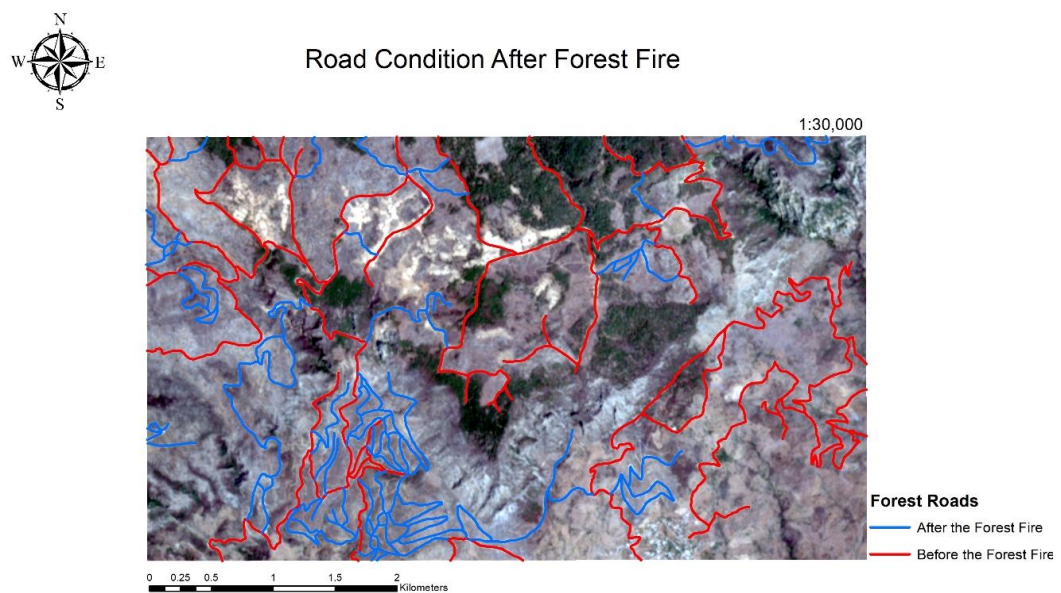

Figure 6. Road condition after the forest fire



### Full-Paper Oral Presentations

The existing forest cover before the fire was 1590.85 ha, and the amount of forest cover for the same area after the fire was determined as 349.35 ha (Table 1). 78% of the forest area in the study area was destroyed by fire.

Table 1. Amount of road and forest cover before and after the fire

	Forest roads (km)	Forest area (ha)
Before the forest fire	50.13	1590.85
After the forest fire	88.85	349.35

The fact that the amount of roads almost doubled after the forest fire, but there was a loss of 78% in the forest area, resulted in the fact that the added or existing roads were not effective enough. The forest roads in the area are not homogeneously distributed, but generally concentrated at certain points.

While the road density in the area was 31.5 m/ha before the fire, it was found to be 55.85 m/ha after the fire. In the communiqué numbered 292, it is emphasized that the road density should not exceed 20 m/ha. Although the road density in this area is above this amount, transportation was difficult during the forest fire. It is thought that this may be due to the fact that the roads do not wrap like a net.

#### 4. Conclusions

The importance of forest roads in firefighting and fire prevention is known. In this study, although the amount of roads increased by 50% compared to the situation after the fire, it was observed that 78% of the forest area was lost. The increase in the presence of forest roads has not been fully effective in preventing fire. For this reason, forest roads and fire safety strips to be built in fire-sensitive areas should be spread more homogeneously and full access to the forest should be aimed.

By making use of Sentinel-2 satellite images, regional analyzes should be made and the conditions of the roads in fire-sensitive areas should be checked, especially in winter.

It is thought that afforestation works with tree species that are sensitive to fire on the slopes of the planned forest roads can prevent both the progression of forest fire and slope shifts.

#### References

- Calvani, G., Marchi, E., Piegai, F., Tesi, E., 1999. Funzioni, classificazione, caratteristiche e pianificazione della viabilità forestale per l'attività di antincendio boschivo. *L'Italia Forestale e Montana* 54(3): 109–125.
- Giannakopoulos, C., Le Sager, P., Bindi, M., Moriondo, M., Kostopoulou, E., Goodess, C.M., 2009. Climatic changes and associated impacts in the Mediterranean resulting from a 2 °C global warming. *Global and Planetary Change* 68(3): 209–224.
- Gumus, S., Acar, H.H., Toksoy, D., 2008. Functional forest road network planning by consideration of environmental impact assessment for wood harvesting. *Environmental Monitoring and Assessment* 142(1–3): 109–116.

### **Full-Paper Oral Presentations**

- Laschi, A., Foderi, C., Fabiano, F., Neri, F., Cambi, M., Mariotti, B., & Marchi, E. 2019. Forest road planning, construction and maintenance to improve forest fire fighting: a review. *Croatian Journal of Forest Engineering: Journal for Theory and Application of Forestry Engineering*, 40(1), 207-219.
- OGM, 2021. 2021 Yılı Orman Yangınları Değerlendirme Raporu, Muğla Orman Bölge Müdürlüğü, Orman Yangınlarıyla Mücadele Şube Müdürlüğü.
- Raftoyannis, Y., Nocentini, S., Marchi, E., Calama Sainz, R., Garcia Guemes, C., Pilas, I., Peric, S., Amaral Paulo, J., Moreira-Marcelino, A.C., Costa-Ferreira, M., Kakouris, E., Lindner, M., 2014. Perceptions of forest experts on climate change and fire management in European Mediterranean forests. *iForest – Biogeosciences and Forestry* 7(1): 33–41.
- Stefanović, B., Stojnić, D., Danilović, M., 2015. Multi-criteria forest road network planning in fire-prone environment: a case study in Serbia. *Journal of Environmental Planning and Management* 59(5): 911–926

**Full-Paper Oral Presentations****Application of Space Information and Digital Elevation Model for Monitoring Lowland and Mountain Forests of the Zaqatala Region of Azerbaijan****Aytaj N. Badalova<sup>1</sup>, Khosiyat R. Ismatova<sup>2</sup>, Natavan R. Jafarova<sup>3\*</sup>**

<sup>1</sup> Aerospace Environmental Monitoring", National Aviation Academy, Baku, Azerbaijan  
<sup>2</sup> Problem laboratory Aerospace monitoring", National Aviation Academy, Baku, Azerbaijan  
<sup>3</sup> Institute of Geography, National Academy of Sciences, Baku, Azerbaijan

\*[jafarova.nata@mail.ru](mailto:jafarova.nata@mail.ru)

---

**Abstract**

Periodic monitoring of the state of forests, timely detection of violations, informing the population about threats to forestry, the use of aerospace monitoring methods and geoinformation technologies is an urgent task in the modern world. This article presents the stages of applying the tools of geoinformation systems for processing a satellite image and a digital model of the relief of the study area. The research was carried out on the example of mountain and lowland forests of the Zaqatala region of Azerbaijan. As a result of processing satellite images and digital relief models of the Zaqatal region of Azerbaijan, maps of slope, exposure, hypsometry, river drainage basins, distribution of vegetation species by heights in the mountainous part of the forest cover were obtained. Using the created maps, an analysis of the state of lowland and mountain forests was carried out.

**Keywords:** *Lowland and mountain forests, Space images, Digital elevation models, Hydrological and geomorphological analysis, Natural extreme situations*

---

**1. Introduction**

The relevance of using remote sensing data and information technologies in forestry is associated with the dynamic growth of the market for space and geoinformation technologies and their effectiveness. Sources of initial data for aerospace monitoring of forest cover can be topographic maps, aerial and space images, digital elevation models, and satellite positioning systems. The use of a geographic information system is a necessary step in improving the quality of aerospace monitoring of the environment, managing forest resources and studying the spatial organization of vegetation cover.

The use of digital elevation models (DEM) is used to obtain morphometric characteristics of the relief, including the calculation of slope angles and aspect of slopes; cross section profiles; estimates of the shape of slopes through curvature, etc. Also, with the help of DEM processing, it is possible to carry out hydrological analysis in order to determine the drainage basins of the rivers of the study area.

Anthropogenic activities associated with deforestation, poaching, forest fires, atmospheric pollution and pollution lead to a reduction in the area occupied by forest. Why is deforestation bad?. Deforestation leads to a decrease in biodiversity, to soil erosion (growth

**Full-Paper Oral Presentations**

of ravines, washing out of the fertile layer), a decrease in the water content of rivers, as well as to an increase in the greenhouse effect. Therefore, an urgent task is periodic monitoring of the state of forests, timely detection of violations, informing the population about threats to forestry, the use of aerospace monitoring methods and modern information technologies. This article shows the methods of aerospace monitoring of mountain and lowland forests on the example of the Zaqatala region of Azerbaijan. The stages of applying the tools of geoinformation systems for processing a satellite image and a digital model of the relief of the study area are given.

**2. Material and Methods**

**2.1. Description of the Study Area**

The Zaqatala region is located in the north-west of the Republic of Azerbaijan, on the southern slope of the Greater Caucasus Mountains (Figure 1-6). From the south it has a border with the Republic of Georgia, from the north - with the Dagestan Republic, from the west and east - with the Balakan and Gakh regions of the Republic of Azerbaijan. The most common landscapes in the region are meadows, mountains and woodlands. As the main trees can be called: beech, oak, hornbeam, linden, black alder, hook pine. There is Zaqatala reserve in the region, it is one of the most ancient reserves in Azerbaijan. It was formed in 1929 on the territory of Zaqatala and Balakan regions. The reserve borders on Georgia.



Figure 1. Zaqatala district



Figure 2. Subalpine meadows



Figure 3. Mountain forest



Figure 4. Shrub and semi-shrubby vegetation



Figure 5. Azersky image of Zaqatala region

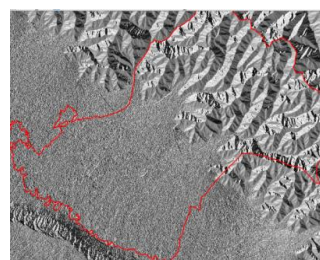

Figure 6. DEM –model of Zaqatala region

## Full-Paper Oral Presentations

The relief of the Zaqatala region is represented by mountainous and lowland areas. Accordingly, there are both mountain forests and lowlands. The vegetation of the Zaqatala reserve is divided into three zones –forest (Figure 1), subalpine woodlands (Figure 4) and the zone of alpine and subalpine meadows (Figure 3). The forest zone includes:

- the lower (Iberian oak, hornbeam), middle (eastern beech) and upper (eastern oak) belts.
- In the subalpine (1850-2300 m) belt, plant formations of meadows and high grass are observed;
- higher, in the alpine (2400-3200) belt - wasteland meadows and bright picturesque alpine carpets.

### 2.2. Research Methods

In different regions, the influence of relief on the differentiation of vegetation properties manifests itself in different ways. The purpose of this work is to identify ecologically significant relief elements by processing a digital relief model and space technologies. Such relief elements include: the height of the terrain above sea level, slope, slope exposure, steepness and river watersheds, and the area of river basins. Based on satellite images, the types of composition and dynamics of vegetation cover, as well as types of land use of the territory, were determined. Based on the foregoing, the stages of processing space images and a digital elevation model are determined as follows:

1. Visual analysis of images and maps of materials;
2. Creation of a digital terrain model using vectorization of maps and images;
3. Choice of image processing methods and apply to the original image;
4. Hydrological analysis of the territory based on the DEM;
5. Geomorphological analysis based on DEM;
6. Interpretation of the results obtained in the processing of maps, images and digital elevation model.

Initial information is as follows:

1. Topographic map scale 1:50000;
2. Space image from the Azersky satellite (MS: 6m; PAN: 1,5; 4 band);
3. Ground measurements.

### 3. Results and Discussion

**Stages 1-2.** Visual analysis and vectorization of the mountainous and lowland parts of the forest on the basis of map materials (Figure 7, 8, 9, 10, 11).



Figure 7. Topomap 1: 50000

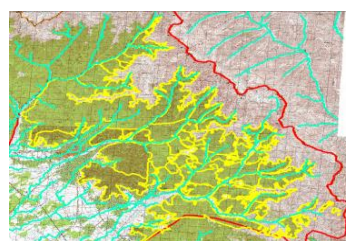

Figure 8. Vectorization of a mountain forest

**Full-Paper Oral Presentations**

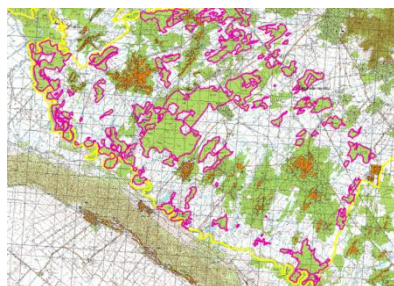

Figure 9. Vectorization of a lowland forest area by map

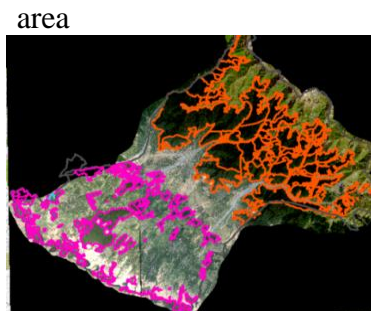

Figure 10. Vectorization of a lowland and a mountain forest area by image



Figure 11. Overlaying the vector layer from map to image (2018)

The area of the Zaqatala region is 1348 sq. km. Digitization of the mountainous part of the forest on a 1:50000 scale map (2001) and calculation of its area showed that the area of the mountain forest is 400.66 sq. km. Based on the result of vectorization of the map at a scale of 1:50000 lowland part of the forest showed that it covers an area of 117.9205 sq. km.

The overlay of the vector layer of mountain forest boundaries from the map (2001) to the image (2018) shows that the boundaries of mountain forests have not changed (Figure 12). Although the boundaries of the mountain-forest contour do not change, processes occur inside the forests that change the landscape (Figure 12.a, b; 13.a, b).



Figure 12.a. Map: 2001



Figure 12.b. Image: 2018



Figure 13.a. Map: 2001



Figure 13.b. Image: 2018

Lowland Forest Dynamics. Vectorization on the map (2001) and on the image (2018) shows the dynamics of the lowland forest in the study area. In the lower part of the district, forests are gradually cut down and developed for agricultural fields (Figure 14.a, b, c).

**Full-Paper Oral Presentations**

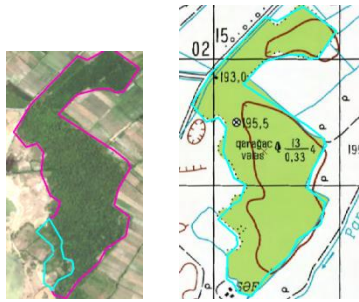

Figure 14.a. fragment of image and lowland forest

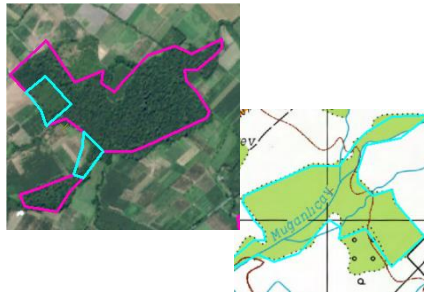

Figure 14.b. fragment of image and lowland forest



Figure 14.c. fragment of image and lowland forest

**Stage 3.** The third stage includes image processing and application of the processing results to the identification of forest cover in the mountainous and lowland parts of the Zaqatala region. Directly on the image, it is difficult to visually separate forests from garden plots and other objects of the earth's surface (Ismatova 2005, Pan et al., 2021). Here it is necessary to use pre-processing (for example, the NDVI index and unsupervised classification). Unsupervised classification is used to create vector files of mountain and lowland forest areas from space images.

The result of unsupervised classification is converted into a vector layer, where we extract the vector layers of mountain and lowland forests. This makes it possible to calculate the areas of forest plots using space information. Therefore, we can compare the areas of forest areas calculated from the map and from satellite images (Mekhtiev Aet al., 2015, Wulder et al., 2018). The advantage of this approach is the fact that forest and non-forest areas are identified quite accurately based on the result of unsupervised classification and the calculation of the NDVI index (Figure 15.a, b, c, d).

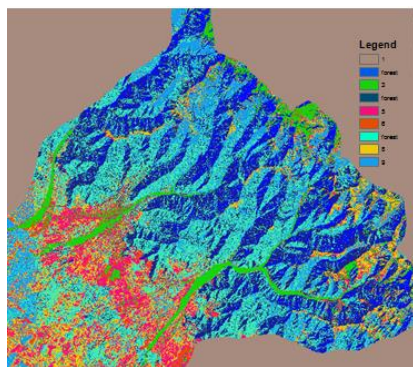

Figure 15.a. Result of unsupervised classification

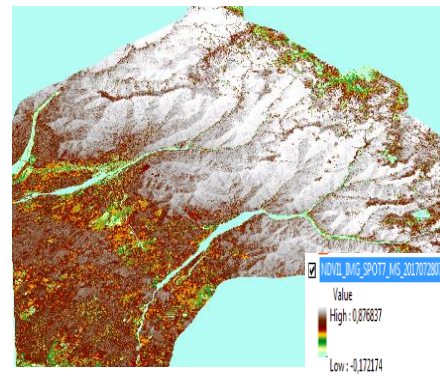

Figure 15.b. Result of NDVI

**Full-Paper Oral Presentations**

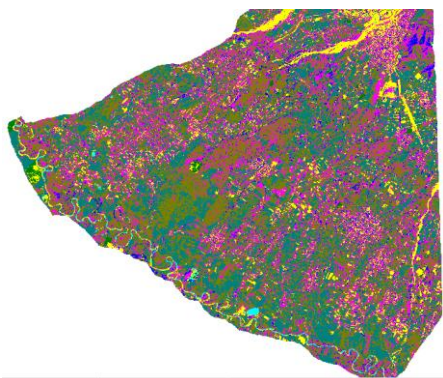

Figure 15.c. Result of unsupervised classification

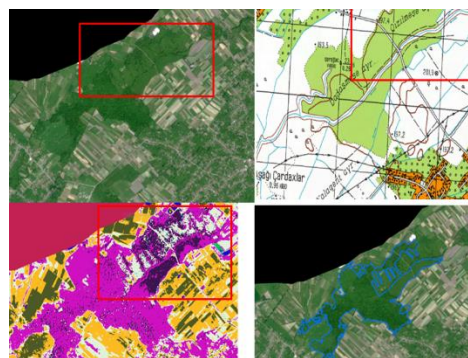

Figure 15.d. Analysis of lowland forest dynamics

**Stage 4. Hydrological analysis of the territory based on the DEM**

When analyzing the distribution of vegetation cover, relief is one of the main factors in its formation, since it is the most stable of all components of forest landscapes. Hydrological analysis involves the construction of a series of surfaces: Fill, Flow Direction, Flow Accumulation, Con flow Accumulation, Stream Connection, Watershed, Stream Order (<https://www.esri.com/en-us/arcgis/products/arcgis-desktop>). /Resources).

This process also includes the creation of vector files for the drainage basins of rivers, river channels, large and small rivers in their order (Motovilov and Gelfan, 2018). This process takes a lot of time, as it is necessary to optimize the surface calculation parameters, connect several hydrological analysis tools, and also perform some calculations using the Map Algebra function in the GIS (<https://tsamsonov.github.io/arcgis-course/dem.html>).

To avoid this lengthy process, we took advantage of the Model Builder tool in ArcGIS 10.4.1. On fig. 16 shows a model of hydrological analysis, where the input information is the DEM of the Zaqatala region. Using the constructed model (Figure 16), we obtained the results shown in Figure 17.f, b, c, d, f. and Figure 18.a, b, c.

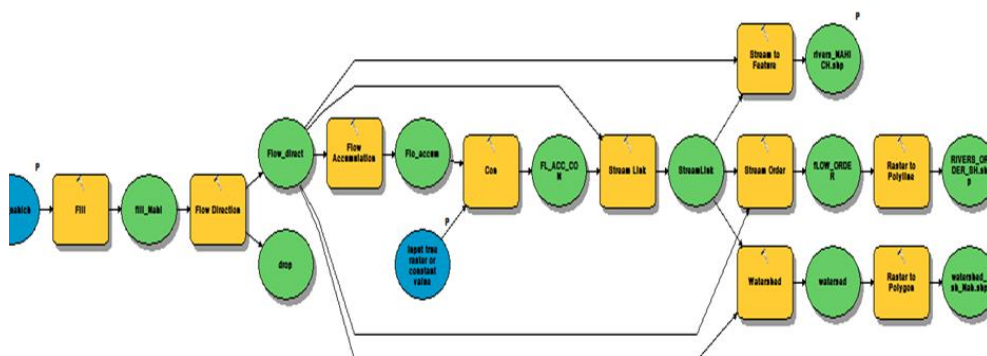

Figure 16. Hydrological analysis model



**Full-Paper Oral Presentations**

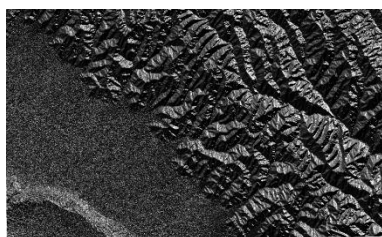

Figure.17.a.Fill- Corrected DEM-model

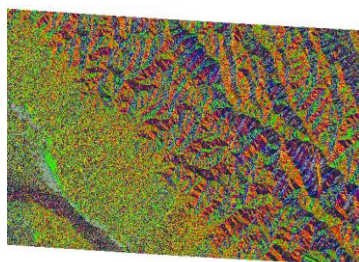

Figure 17.b.Flow direction -rastr

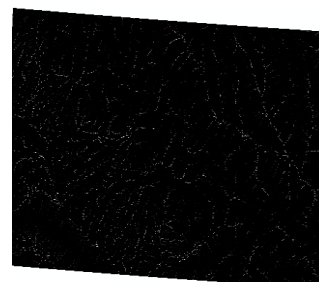

Figure 17.c.Flow accumulation - rastr

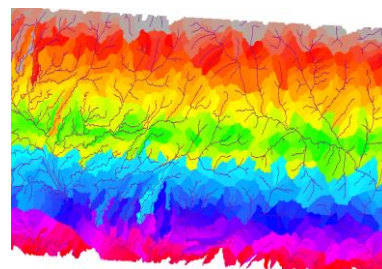
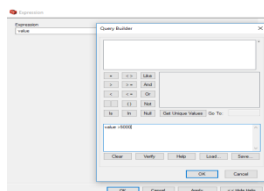
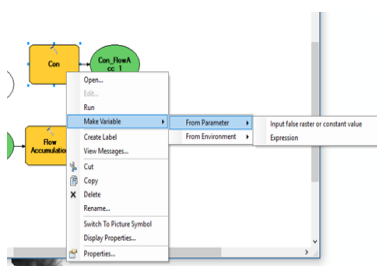

Figure 17.d. A request is entered for the density of the river network, in our case: value>5000. To implement this request, use the tool:

Spatial Analyst- Conditional -CON with parameter: value>5000

Figure.17.d. Watershed raster and river vector layer



Figure 18.a. Vector layer of drainage basins of rivers in the mountainous part of the Zaqatala region

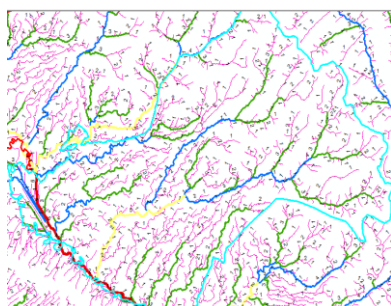

Figure 18.b. Feature layer of the order of large and small rivers

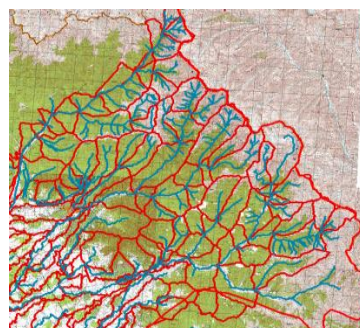

Figure 18.c. Overlaying a river basin layer and a river layer on a map shows the accuracy of the hydrological analysis model and its outputs

**Stage 5. Geomorphological analysis based on DEM.**

When choosing geomorphometric characteristics, it is necessary to take into account the features of the relief of a particular territory, the specifics of the mechanisms of its influence on the processes of vegetation cover differentiation (Mekhtiev et al., 2015). According to many authors the formation of vegetation diversity is influenced by a number of major topographic factors, such as absolute height, surface slope and aspect. Thus, the absolute height determines the vertical zonation of soils and vegetation in mountainous regions. The steepness and orientation of slopes control the speed and direction of surface flows, the

**Full-Paper Oral Presentations**

intensity of precipitation evaporation, snowmelt, and some soil properties ((<https://tsamsonov.github.io/arcgis-course/dem.html>)). All of the above indicators affect the composition of forest species growing on various landforms. In this work, with the help of GIS tools and on the basis of DEM, maps of slopes (Figure 19.a), absolute heights (Figure 19.b), aspect maps (Figure 19.c) were built.

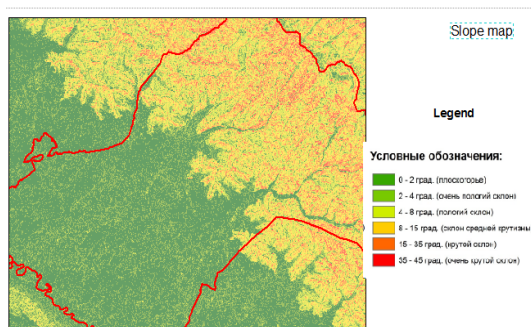

Figure 19.a. Slope map

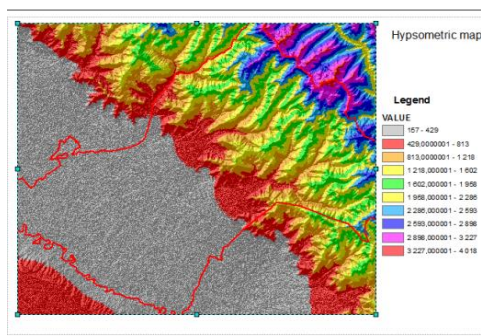

Figure 19.b. Absolute height map

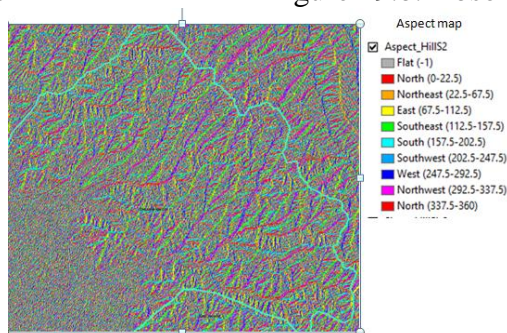

Figure 19.c. Aspect map

**Stage 6.** Interpretation of the results obtained during the processing of maps, images and digital elevation model.

The performed procedures of hydrological and geomorphological analysis, as well as uncontrolled classification are the basis for identifying possible risks of natural or man-made emergencies in river basins (Figure 20), (Wulder et al., 2005). The consequences of extreme situations adversely affect the state of the forest, for example, as a result of landslides or mudflows, the fertile soil layer is washed away.

Hence, when analyzing maps created as a result of processing DEM and satellite images, it can be seen that in the mountainous part of the study area, the main parameters of the slope are clearly visible, the direction and steepness of the slope of which are extreme for the risk of emergency situations. So the map (Figure 20), obtained as a result of the integration of the height map, the raster of unsupervised classification and the vector layers of the drainage basins of the rivers, it is possible to identify areas of river basins where risks of emergency situations are possible. Figure 20 shows, that these are watersheds with numbers 222, 418, 515. On the example of a basin with number 222 (Figure 21.a, b), this fact can be confirmed by analyzing slope maps and aspect. As we see in Fig. 21. a., risks arise when the slope of the terrain is more than 45 degrees, and in Figure 21.b the main direction of the slope is northwestern and western.

**Full-Paper Oral Presentations**

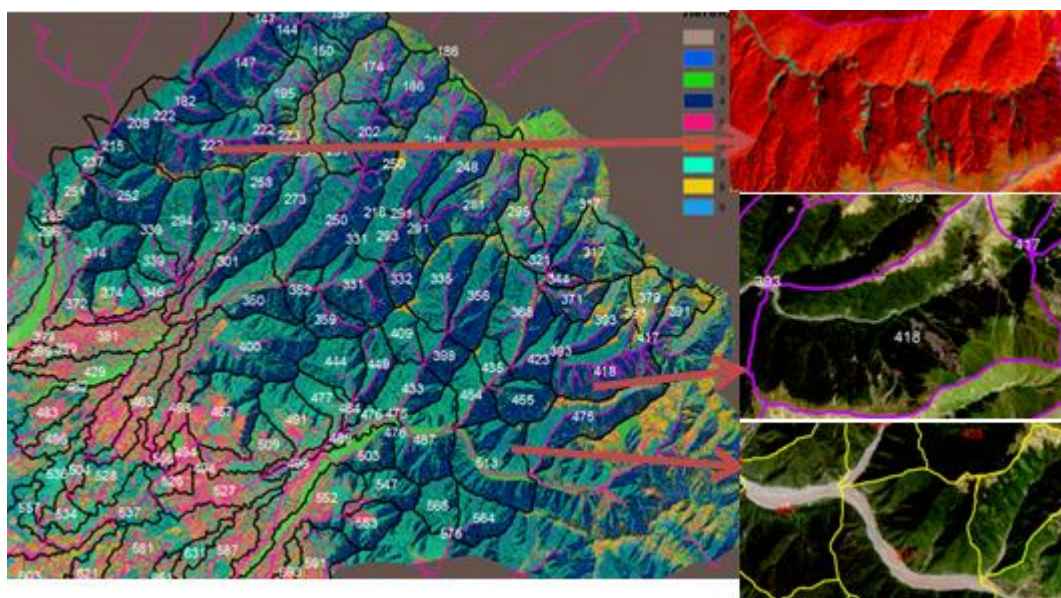

Figure 20. Result of hydrological analysis and unsupervised classification and The result of hydrological analysis and uncontrolled classification and river basins where risks of extreme situations are possible (for example, a landslide or mudflows , floods or deforestation)

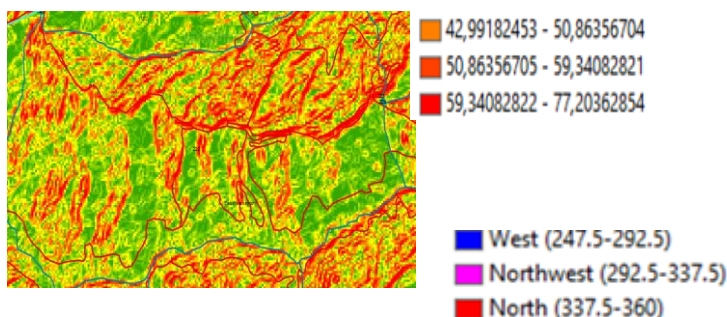

Figure 21.a. River drainage basin No. 222. Slope

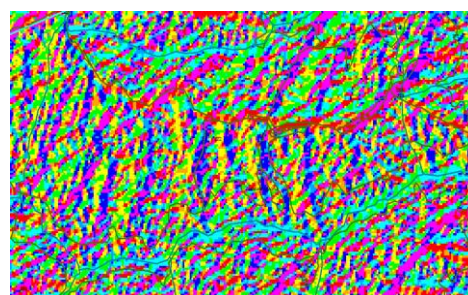

Figure 21.b. River drainage basin No. 222. Aspect

As a result of space image processing and its interpretation, a vector layer of distribution of tree species was obtained in the mountainous and lowland parts of the study area. In Figure 22. an integral map of the distribution of forest species by heights in the mountainous part is presented. The following symbols are on the map: On the map the following designations: fistiq- beech, veles -hornbeam, palid – oak, qaragac-elm, qizilagac – alder.

**Full-Paper Oral Presentations**

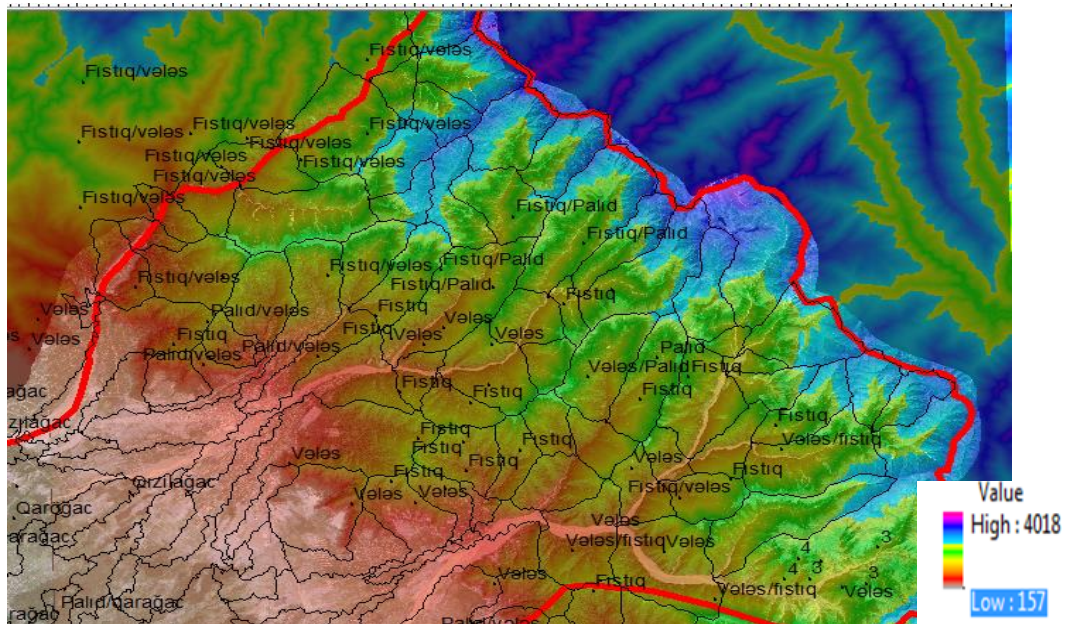

Figure 22. As a result of processing the satellite image and DEM, the following results were obtained: 1. river drainage basins, 2. height map and 3. location of forest species in mountainous terrain

**Conclusion**

At present, space and geoinformation technologies are widely used in solving problems of protection and forestry management. Space technologies and geoinformation technologies are a spatial tool for forest monitoring. In this work, we used a variety of tools for the analysis of spatial information, which include the processing of space images and digital elevation models. Integration of various data (maps, space images, digital terrain models) and methods of their processing in a single information environment allows you to identify the dynamics of forest landscapes, identify risk zones for extreme forest situations. As a result of processing satellite images and digital relief models of the Zaqatala region of Azerbaijan, maps of slope, exposure, hypsometry, river drainage basins, distribution of vegetation species by heights in the mountainous part of the forest cover were obtained. Using the created maps, an analysis of the state of lowland and mountain forests was carried out. Forest vegetation on mountain slopes is evenly distributed between slopes with different slopes. The area of plots occupied by forest vegetation, depending on the exposure of slopes in areas of possible risk of extreme natural situations, is distributed between the cardinal points, with a predominance of western and northwestern slopes. The boundaries of the contour of the mountain forest do not change, but processes occur inside that change the landscape of the area. In the lower part of the district, forests are gradually cut down and developed for agricultural fields.

**References**

Mekhtiev A.Sh., Ismatova H.R., Agayeva K.S. 2015. Creation and updating of cartographic material for landslide hazard assessment based on remote sensing data. National Aviation Academy, Scientific works. Volume 17., cild 17, №. 1, ISSN 1811-7341, pp. 76-81  
 Ismatova Kh.R. 2005. The role of remote sensing data in land use mapping in Azerbaijan. Modern problems of remote sensing of the Earth from space. Moscow. 273-278.

**Full-Paper Oral Presentations**

- Motovilov Yu.G., Gelfan A.N. 2018. Models of runoff formation in problems of hydrology of river basins. Moscow, Russian Academy of Sciences, 296p.
- Pan, X., Wang, Z., Gao, Y., Dang, X., & Han, Y. (2021). Detailed and automated land use/land cover classification using machine learning algorithms in Google Earth Engine. Geomap International. 1-18.
- Wulder M. A., Hall, R. J., Franklin, S. E., 2005. Remote sensing and GIS in forestry. Remote sensing for GIS managers. ESRI Press, Redlands, 351-362.
- <https://www.esri.com/en-us/arcgis/products/arcgis-desktop/resources>
- <https://tsamsonov.github.io/arcgis-course/dem.html>

**Full-Paper Oral Presentations****Determination of Work Efficiency and Physical Workload During the Winching Operation by Farm Tractor****Sadık ÇAĞLAR**Kastamonu University, Faculty of Forestry, 37150 Kastamonu, Türkiye  
[scaglar@kastamonu.edu.tr](mailto:scaglar@kastamonu.edu.tr)**Abstract**

Winching is a common practice for extracting (primer transport) harvested trees in forest operations in Turkey. However, it requires significant physical effort by human to pull-out the cable to the felling site. The aims of this study were; (1) to determine the work cycle time, (2) to calculate the productivity of a Solis-75 farm tractor and (3) to identify the physical workload of the choker setter under the experimental conditions with during the winching operation. This research was conducted in Kastamonu RDF at the summer period during the extraction of harvested tree-length (TL) materials. Time studies and working heart rate (HRw) measurements was realized while the extraction of the harvested black pine (*Pinus nigra*). The harvested TL materials were winched from felling area to uphill and they were skidded to landing areas at road side. The average ground slope of the winching direction was 60% at harvesting area. The average winching distances were realized 35,94 from felling area to landing area. The mean productivity of the farm tractor (Yanmar Solis-75) was calculated as 11,47 m<sup>3</sup>/hour  $\pm$  3,88 (mean  $\pm$  SD). The mean HRw of the choker setter was 133 bpm and workload class was determined as “extremely heavy” work severity.

**Key words:** *Winching, Time study, Productivity, Workload.*

**1. Introduction**

Forestry activities, such as extraction, are heavy and quite costly in the mountainous terrain conditions (Çağlar et al, 2007). Because of difficulties in the extraction of the harvested woody materials, machine usage has become more important during the harvested wood extraction at the steep terrain for the productivity and safety of the both machine and workers.

There are two stages in the transportation of harvested wood materials from forest. The first one is primer transportation is to transport products from stump to landing areas on road. The second transportation is to transport these materials from the landing areas to the forest depots or trading storage (Aykut, 1985; Çağlar, 2016). The primer transportation is considered as the most dangerous, difficult, expensive and time-consuming tasks especially on the difficult terrain conditions (Çağlar, 2020).

Harvesting systems and methods used for harvesting activities such as felling, processing, primary transportations to the landing area, loading and log transportation to the mill greatly affect overall harvesting cost, productivity (volume of logs produced per hour during a harvesting operations), overall profitability of harvesting operations, and return landowners (Adebayo et al, 2007).

**Full-Paper Oral Presentations**

Full-tree harvesting (FTH), tree-length harvesting (TLH) and cut-to-length (CTL) methods usually are applied in wood harvesting. These methods differ in relation to the technology utilized (Gerasimov and Sokolov, 2014). In the FTH method, the trees are felled and transported to the landing area with the branches. Delimiting and, if necessary, bucking is performed at the roadside. In the TLH method, trees are delimited and topped immediately after felling in the stump area, and then the intact stems are skidded to the roadside landing. In the CTL method, the trees are felled, delimited and bucked in the stump site and logs are transported to the landing area (Gerasimov and Sokolov, 2014; Çağlar, 2020). These wood harvesting methods are essential for effective forest management and achievement of economic and environmental sustainability (Marchi et al. 2018; Soman et al. 2020; Lee and Lee).

Currently, about 55 percent of the world’s wood harvest is performed manually with chain saw while the remaining 45 percent is harvested mechanically (Adebayo et al, 2007). Today, two thirds of the world’s mechanized industrial timber harvesting are done by CTL machinery. Within the EU, the CTL method is used for over 70 percent of both mechanized and manual timber harvesting (Ponsse, 2022).

S T A G E	TREE HARVESTING PROCESS		
	CUTTING	TRANSPORT STAGE	
		PRIMER TRANSPORT	SECONDER TRANSPORT
A	Cutting preparation	Preparation	Loading
C	Cutting-felling	Loading (fastening)	Transportation on road
T	Delimiting	Extraction (skidding, hauling)	Unloading
I	Topping	Unloading (untie)	
I	Measuring marking		
T	Bucking	Timber stacking (temporarily stacking)	Storage
E	Debarking		
S			

Figure 1. Tree harvesting with chainsaw and transport stages in Türkiye (Çağlar, 2016)

Manual harvesting methods have traditionally been preferred for steep slope harvesting. Manual slope harvesting uses various winch and cable line systems as aids. Compared to mechanized harvesting, manual forestry is extremely strenuous and dangerous. In some countries, nearly three percent of loggers are injured or killed each year while carrying out manual forestry. Replacing manual harvesting with mechanized methods is by far the most effective way to reduce accidents and to improve the safety of workers (Ponsse, 2022).

Generally, farm tractors have been combined with the light scale winches and its drums to haul small volume harvested trees (Çağlar, 2016). Because of the low investment costs, the modified farm tractors usage is a common solution for the extraction of wood-based forest products on gentle terrain condition in Türkiye (Çağlar, 2020). The farm tractors can skid logs downhill, up to 25% ground slope. The winch-attached farm tractors are used for uphill extraction of logs up to distance of 30 m to 50 m (Akay, 2005).

## Full-Paper Oral Presentations

Cable operations can only be performed by means of several men co-operating as a crew. Some of them are the field workers and the others work at the landing. The number of workers in a crew depends on the size of the equipment. Light cable cranes suitable for 200-300 meter and with tree dimensions less than 1 m<sup>3</sup>/tree are often operated by a two men crew, one winch operator and one field worker (Samset, 1985).

The determination of the degree of efficiency and how to upgrade the degree of efficiency of workers without harming the workforce are the main issues for the research of ergonomics. It is essential to reveal the both machine and employee's productivities in variable operating conditions by analysing these effects (Çağlar, 2016). The productivity of the farm tractors depends on various factors including machine and attached equipment's type, conditions of the forest ground and stand, weather conditions, and the experience and skills of the operators (Gullberg, 1995; Öztürk, 2010a; Çağlar 2016; Çağlar 2020). In a study conducted by Çağlar (2016), the productivity of MB Trac 900 forest tractor was determined as 4.172 m<sup>3</sup>/hour for the 47 m extraction distances from felling area to the forest road side landing place at the 55 % ground slope conditions. In another study Çağlar (2020) determined that the average hourly productivity of Bronson 6530 farm tractor was calculated as 5.80 m<sup>3</sup>/hour for 37 m extraction distance and for 35% ground slope conditions. The most time-consuming work element was winching (49.2%), followed with delay time (20.1%). A positive result of the mechanization of harvesting work is the drastic reduction in serious accidents and injuries (Potočnik et al., 2009). However, increasing mechanization is posing new problems (Gerasimov and Sokolov, 2014). In a research conducted by Potocnik et al (2014), the percentage of the accidents determined as 68% in felling and 24% during skidding in forest operations in Slovenian state forests in the period 1990–2005. The height, weight, physical fitness, age and sex of the workers are the main factors in competitive situations. In addition, various environmental conditions, including cold, heat, humidity, wind, altitude, ground surface and terrain, as well as clothing and equipment worn, significantly affect the energy costs of activities (Berendt et al., 2020; Çağlar, 2021).

## 2. Materials and Methods

The forests in the western black sea region of Türkiye are located on the mountainous and steep terrain. The mountains spread from sea level up to 2500 m altitude within Kastamonu in Türkiye. The harvesting areas of black pine forests are located on hilly and steep slopes. The experimental site is located in Tezcan Forestry District (FD) in Bozkurt, Kastamonu Regional Directorate of Forestry (RDF) in north west of Türkiye (Figure 2). The tree length (TL) harvested materials was extracted at the summer period.

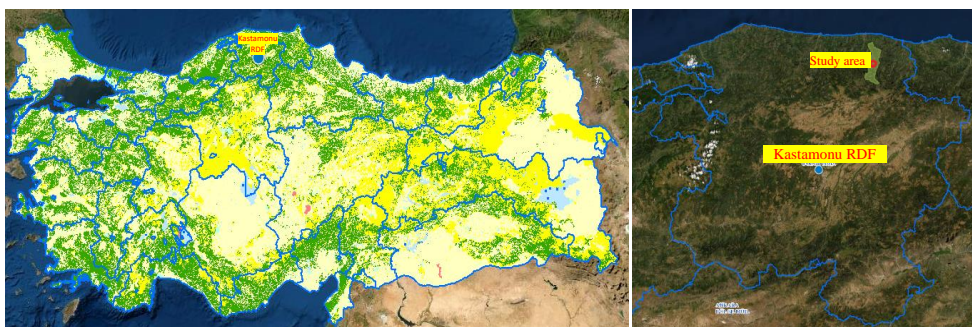

Figure 2. Map of the study area in Kastamonu RDF



**Full-Paper Oral Presentations**

A winch mounted farm tractor (Yanmar Solis-75) used for extraction of the harvested black pine (*Pinus nigra*) from felling area to the roadside. Farm tractor has one winch (drum) during the cable winching operations. The steel cable lengths on the winch was 150 m with 12 mm diameter (Table 1).

Table 1. Technical specification of the Yanmar-Solis 75 farm tractor

Features name	Yanmar Solis-75
Machine weight	3362 kg
Engine	Diesel / 71 kW (95 HP)
Cylinders	4
Cylinder capacity	3707 cm <sup>3</sup>
PTO speed (rpm)	540/540E
Fuel capacity	64 lt
Lifting capacity	2500 kg
Number of Gears	3362 kg
Forward / backward	12 /12
Cable diameter / length /weight	12 mm/ 150 m/ 0.73 kg/m
Tire size (front / rear)	11.2-24 /16.9-30



The winching operation was realized from downhill to uphill direction (uphill winching). The workplace conditions, the time measurement related to a work cycle and the heart beats of the worker was realized to calculate the productivity and physical workload of the worker during the winching operations, as well.

**2.1. Working conditions, time measurement and productivity**

A field trial during winching operations was conducted in June, 2022. The working conditions were in dry terrain conditions with a mean day temperature of 33°C and a mean humidity of 60%. The altitude of the experimental site was 740 m above sea level. There were no logging residues on the selected corridors. The living ground cover percentage on the cable hauling lane 20%.

Two professional male forest workers (operator and choker setter) conducted trial of the winching operations within one working day. The participation was voluntary and the test person had to right to decline or withdraw from participation at any time. Both test persons were familiar with the cable extraction work under condition of region. Polar RS800 heart rate monitor was attached to the chest of the choker setters who connected the steel cable and his heart rates were recorded during winching operation.

Time measurements of the work elements in a cycle have been performed in order to determine the productivity of the machine. To determine the physical workload that the workers are exposed to, both time study and heart rate measurements were realized simultaneously.

The time study was carried out at the site following the continuous timing method by means of the chronometer. The series of work elements of farm tractor (Yanmar Solis-75) constitutes the work cycle at harvesting area. These work elements are known as dependent variables. Delay time values were excluded from the total cycle time to calculate the pure cycle time (Table 2).

The farm tractor was positioned on the roadside at the start of a work cycle of the uphill winching operations. And then the steel cable was pulled out by the worker (walk out) to the

**Full-Paper Oral Presentations**

loads location. The cable was hooked up to loads by the worker (choker setter) and after that the cable was hauled back (in-haul) from felling area to landing. The worker had to follow the load during the winching of the load (walk in) to be ready to start the next cycle. (Figure 3).



Figure 3. Main work elements in a cycle during winching operation with tractor

Dependent time variables and independent variables were symbolized as  $T_i$  and  $X_i$  respectively (Table 2). Independent variables are effective variables on the work elements in a cycle. The independent variables mostly belong to the ground, forest, stand, weather conditions and the specifications of the machine, equipment’s and the workers. Some of them changeable during the cable haulage and they have significant effect on the working productivity (Çağlar, 2016).

The main independent variables affecting the working time are; the cable haulage distance ( $X_1$ ) in which the worker walk out and walk in (m), the diameter of logs (cm) ( $X_2$ ) and the length of logs ( $X_3$ ), volume of the load ( $X_4$ ) for each cycle and the slope percentage (%) of the cable haulage corridor ( $X_5$ ).

Table 2. Definition of the dependent variables in a cycle at winching operation.

Work element	Definition
$T_1$ :Preparation	Starts when the tractor reached to the start of corridor at roadside and ends when the cable is released unattached from winch drum.
$T_2$ : Pull out (walk out)	Starts when the cable was unattached from drum and ends when the cable is pulled out to the loads by the worker.
$T_3$ : Hook	Starts when the worker pulled out the cable to location of load and ends when loads completely hooked up and the worker gives the signal for the load to be hauled in.
$T_4$ : In-haul (walk in)	Starts when the worker gives the command that in-haul can begin and ends when the load reached to e landing. Worker follows the loads while the cable hauled back from felling area to the landing.
$T_5$ : Unhook	Starts when the load is hauled to the landing at roadside and ends when the worker unhook the chokers from load.
$T_6$ : Unloaded return	Starts when the log unhooked at the road side and ends when the unloaded tractor reached to the starting point of corridor.
$T_7$ : Delay	Includes operational, mechanical and personal delay times
PCT: Pure cycle time	Delay free time
TCT: Total cycle time	Includes delays

**Full-Paper Oral Presentations**

At the end of each winching work cycle, the diameter and the length of each logs were measured at landing. Huber’s formula was used, based on the length and medium diameter of the logs Equation (1):

$$V = \frac{\pi}{4} \times (d)^2 \times L \tag{1}$$

where V: volume (m<sup>3</sup>), d: diameter of the log (m) and L: length of the log (m). Then, the production rate was calculated, using Equation (2) (Stampfer et al., 2010):

$$P = (V/T) \times 60 \tag{2}$$

where P is the productivity (m<sup>3</sup>/productive machine hour (PMH)), V is the volume of the log (m<sup>3</sup>) and T is the yarding cycle time (min).

**2.2. Physiological measurements**

Polar RS800 sport heart-rate monitor was fitted to the worker chests to determine worker’s resting (HRr) and working heart (HRw) beats per min (bpm) for calculation of the physical workload (%HRR) of the worker (Figure 4).



Figure 4. a) Polar RS800CX training computer and b) Polar transmitter

Polar RS800CX training computer displays and records the heart rate and other exercise data during exercise (Figure 4-a). Polar WearLink transmitter: sends the heart rate signal to the training computer. Includes a connector and strap (Figure 4-b) (Polar, 2022). The %HRR has been used as a parameter that allows direct comparison between test workers (Berendt et al. 2020; Çağlar 2021). The heart rate reserve (%HRR) is defined using Equation (3) (Karvonen et al., 1957):

$$\%HRR = \left[ \frac{(HRw - HRr)}{(HRmax - HRr)} \right] * 100 \tag{3}$$

where %HRR is physical workload, HRw is heart rate at work (bpm), HRr is heart rate at rest (bpm) and HRmax is maximum heart rate (220- age). The heart rate and physical workload (%HRR) values were classified according to heart rate (Çağlar, 2021). By using the %HRR values of the worker, the work severity was classified using the Table 3.

Table 3. Classification of physical workload (%HRR) in terms of hearth rate.

Work severity	Heart rate (bpm)	Physical workload (%HRR)
Light work	<90	<30
Moderate work	91-110	31-40
Heavy work	111-130	41-50
Very heavy work	131-150	51-60
Extremely heavy work	>151	>61

**Full-Paper Oral Presentations**

To measure the resting heart rate (HR<sub>r</sub>), the worker was asked to sit down and relax, without moving, drinking anything or smoking, for 15 mins (Kirk and Sullman 2001; Çağlar 2021). The working heart rates (HR<sub>w</sub>) were recorded on heart rate monitor for the entire day during winching operation. At the end of the winching operations, the HR<sub>w</sub> was derived from the average rate for winching operations. The maximum heart rate (HR<sub>max</sub>) was calculated for worker using the Equations (2) in which subtracting the age (years) of the worker from the 220 value (Berendt et al. 2020; Çağlar 2021).

$$HR_{max} = 220 - \text{Age} \tag{4}$$

The body mass index (BMI) was calculated by dividing body weight of the worker (kg) by the square of the worker’s height (m). The BMI values (kg/m<sup>2</sup>) were classed as underweight (<19.9), normal (20-25) and overweight (>25) (Kirk and Sulman 2001; Çağlar 2021).

**3. Results and Discussion**

In this study, independent variables affecting the work cycle time and physical workload were studied during winching operations by using a winch mounted farm tractor at mixed stand with black pine (*Pinus nigra*) and oak (*Quercus sp*) in Kastamonu, Turkiye. The tree length (TL) harvested black pine materials was extracted from felling area to the landing at roadside. Jacke et al. (2006) verified in a skidder winch trial that pulling a steel cable during the pull-out in an uphill direction can be conducted only under exceptional conditions and only for very short distances. Generally, downhill winching should be avoided whenever possible for ergonomic and safety reasons (Aalmo Ottaviani et al., 2016; Berendt et al., 2020). This why, uphill winching operations were carried out with a farm tractor in this study. During the winching operations of the farm tractor, totally 33 cycle times measured. There were two voluntary test persons (choker setter and operator). The meteorological conditions were similar during for the work day with a mean temperature of 33°C and a mean humidity of 60%.

**3.1. Work time and productivity results**

As independent variables; the results in this study showed that the mean winching distance was 35.94 ± 10.6 m from felling area to landing. The mean diameter and length of the extracted TL harvested materials were 25.9 ± 2.5 cm and 12.7 ± 2.3 m, respectively. The average volume was 0.678 ± 2.3 m<sup>3</sup> per cycle. The mean slope (%) of cable haulage corridor was 59.5 ± 4.6% (Table 4). During winching operations, one piece of tree length load was hauled in each cycle.

Table 4. Independent and dependent variables and their descriptive statistics.

	X <sub>1</sub> : Distance	X <sub>2</sub> : Diameter	X <sub>3</sub> : Length	X <sub>4</sub> : Volume	X <sub>5</sub> : Slope	T <sub>1</sub> : Preparation time	T <sub>2</sub> : Pull-out time	T <sub>3</sub> : Hook time	T <sub>4</sub> : In-haul (walk in)	T <sub>5</sub> : Unhook time	T <sub>6</sub> : Unloaded return time	T <sub>7</sub> : Delay time	PCT: Pure cycle time	TCT: Total cycle time (includes
	m	cm	m	m <sup>3</sup>	%	min.	min.	min.	min.	min.	min.	min.	min.	min.
Average	35.9	25.9	12.7	0.678	59.5	0.40	0.57	0.34	1.34	0.26	0.39	0.65	3.30	3.94
Maximum	58	30	16	1.039	65	0.75	0.85	0.80	3.27	0.88	0.93	6.53	5.67	12.20
Minimum	21	23	10	0.411	50	0.22	0.27	0.08	0.60	0.08	0.00	0.00	2.25	2.25
Std. Dev.	10.6	2.5	2.3	0.211	4,57	0.15	0.21	0.21	0.64	0.19	0.30	1.57	0.97	2.31
	Percentages of work stages (%)					10.2	14.4	8.6	33.9	6.7	9.8	16.4	83.6	100.0

**Full-Paper Oral Presentations**

The average total cycle time and pure cycle time were  $3.94 \pm 2.31$  min and  $3.30 \pm 0.97$  min, respectively. Mean pull-out time and walk-in time per total cycle were  $0.57 \pm 0.21$  min and  $1.34 \pm 0.64$  min, respectively for 35.9 m winching distance. Berendt et al. (2020) determined the average pull-out time of the cable (downhill) by the worker and winching (in-haul) time was determined as 0.48 min and 1.22 min, respectively, in a work cycle for the 50 m distance. The results of both study are similar.

In this study for winch mounted farm tractor, percentage (%) of work elements in total cycle time (TCT) time were determined as  $T_4 > T_7 > T_2 > T_1 > T_6 > T_3 > T_5$  (6.7%) (Table 4). Within the work elements, the in-haul time ( $T_4=1.34$  min) was the one with the highest time consumption rate (33.9%) (Figure 5). At this work stage, the worker followed the loads while it was winched from felling area to the landing. This means that, this work stage and the corridor must be regulated for the more productive work by farm tractor. The same result was determined in a study realized by Çağlar (2016) by using MB Trac 900 forest tractor. The percentage of the work elements in cycle is similar to Çağlar (2020).

The percentage of the preparation time ( $T_1$ ) and the unloaded return time ( $T_6$ ) of the farm tractor were 10.2% and 9.8%, respectively. The delay times were observed only in 14 work cycles. The mean delay time ( $T_7$ ) percent in total cycle time was 16.4% (Table 4).

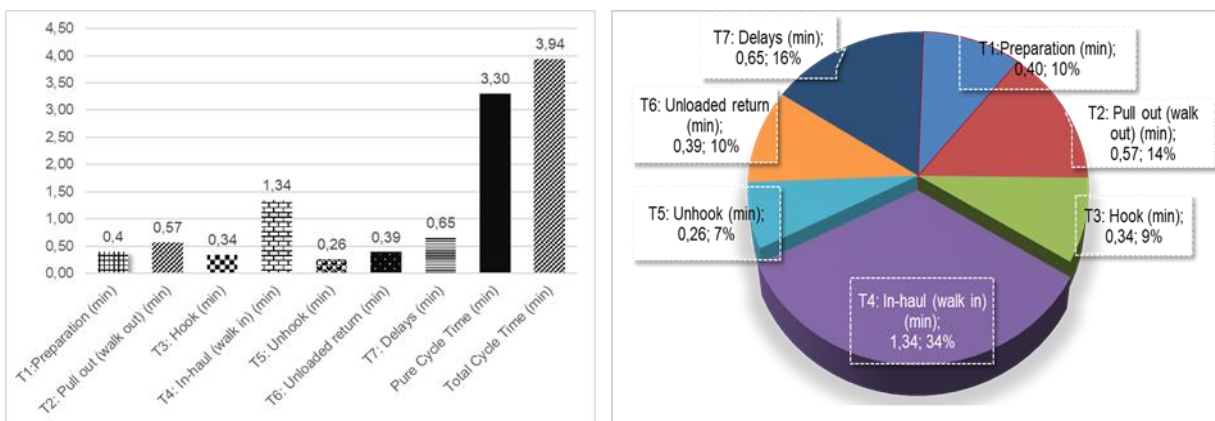

Figure 5. Average values and percentage of work elements in total cycle time.

According to these results, sum of percentages of the work elements in which worker had to work intensively (pull-out, hook, in-haul and unhook) was 63,6% in a cycle (Table 4). The worker had irregular walking speed during the pull-out. But, during the walk-in, following the winching load hook, the velocity of the winch mostly determined the walking speed of the worker. The average productivities per cycle and per hour were calculated as 0.68 m<sup>3</sup>/cycle and 11.47 m<sup>3</sup>/hour, respectively. The productivity values of the farm tractor at given conditions are given in Table 5.

Table 5. Productivity values of cycle time during winching operations.

	Units	Total Cycle Time
Productivity values	min/cycle (± SD)	3.94 (± 2.31)
	m <sup>3</sup> /cycle (± SD)	0.68 (± 0.21)
	m <sup>3</sup> /hour (± SD)	11.47 (± 3.72)

**Full-Paper Oral Presentations**

Çağlar (2020) reported that the cycle time was 6.39 min and the productivity were 5.80 m<sup>3</sup>/hour. In this present study, the hourly productivity was higher (11.47) than Çağlar (2020) because the cycle time was 3.94 min in this study. This difference may be attribute to the factors such as delay time and machine power.

There was a positive correlation between pure cycle time and the winching distance (r=0.486), length of logs and the volume at the 99% significant level and the slope and the diameter at the 99% significant level. There was also a positive correlation between total cycle time and same independent variables at %99 and %95 significant level. There was a positive correlation between productivity and log length at the 95% significant level (Table 6).

Table 6. Correlations coefficients between dependent and independent variables

Dependent variables	Independent variables				
	Distance	Slope	Diameter	Length	Volume
Pure Cycle Time (PCT)	0.486**	0.410*	0.353*	0.513**	0.546**
Total Cycle Time (TCT)	0.557**	0.367*	0.453**	0.366*	0.520**
Productivity	-0.235	-0.288	0.229	0.355*	0.318

\* Correlation is significant at the 0.05 level, \*\* Correlation is significant at the 0.01 level.

**3.2. Physical workload results**

The worker was 49 years old with 33 years of work experience during the winching operations. Work experience of the worker was 33 years. Worker has never smoked and drank alcohol in his life. The average height and weight of the worker was 180 cm and 90 kg respectively. The BMI value of the worker was calculated as 27.78 kg/m<sup>2</sup> (Table 7). The BMI value of the worker were classes as «overweight».

Table 7. Anthropometric information, heart rates and workload values of worker.

Subject	Age (years)	Height (cm)	Weight (kg)	BMI (kg/m <sup>2</sup> )	Work experience (years)	HRmax (220-age) (bpm)	Heart rate at work (HRw) (bpm)			Heart rate at rest (HRr) (bpm)	Physical workload (HRR %)
							min	max	mean		
Worker	49	180	90	27.78	33	171	115	150	133	58	66.37

The average resting heart rate (HRr) was 58 bpm, ranging from 55 to 63 bpm. The working heart rate (HRw) varied from 115 to 150 bpm for worker. The HRmax was calculated as 171 bpm related to worker age. The mean physical workload (HRR%) of the worker was calculated as 66.37% for the winching operations. This value being classed as extremely heavy work (Table 7).

**4. Conclusion and Suggestions**

This study focused on the time consumption, productivity and physical workload of worker involved in winching operation at stump site using a farm tractor; however environmental, economic and work safety aspects of winching operations should also be taken consideration. In the context of this study, we verified that winching activities are time consuming, and carry a significant and extremely heavy workload for the worker during winching operations. The following suggestions can be given for the future studies;

### Full-Paper Oral Presentations

- Measures should be taken to reduce the level of physical workload (HRR%) at which the worker can work without difficulty.
- To get more accurate results, same research should be realized in different harvesting areas by using the farm tractor.
- During the winching operation, the work safety and work efficiency should be taken as a priority.

### References

- Adebayo, AB., Han HS., Leonard J. 2007. Productivity and cost of cut-to-length and whole-tree harvesting in a mixed-conifer stand. *Forest Products Journal*, Jun 2007; 57, 6; ProQuest Central pg. 59.
- Aalmo Ottaviani G, Magagnotti N, Spinelli R. 2016. Forest workers and steep terrain winching: the impact of environmental and anthropometric parameters on performance. *Croatian J For Eng.* 37:97–105.
- Akay, A., 2005. Using farm tractors in small-scale forest harvesting operations, *Journal of Applied Sciences Research*, 1(2): 196-199.
- Berendt F, Hoffmann S, Jaeger D, Prettin S, Schweier J. 2020. Application of spiroergometry to determine work metabolism related strain in the course of cable work with a mini forestry crawler. *Int J For Eng.* 31(2):114-125. doi: 10.1080/14942119.2020.1735198.
- Çağlar, S., Acar H.H., Çalışkan E., 2007, An Examination on Machine Extraction Systems in Turkish Forestry, *Annals Of Warsaw Agricultural University (SGGW)*, 6th Conference On Agricultural And Forest Engineering, 14-15 June 2007, pp.249, Warsaw, Poland.
- Çağlar, S., 2016. Productivity of the MB Trac 900 tractor at the mixed conifer stands: an example of Artvin forest in Turkey, In: *Proceedings of The Conference on International Forestry Symposium (IFS 2016)*. 07- 10 December, Kastamonu/Turkiye.
- Çağlar, S., 2020. Productivity Analysis of Tree-Length Harvesting using Farm Tractor in a Nordmann Fir Stand in Turkey, *European Journal of Forest Engineering (EJFE)*. 2020, 6(2):78-86. <https://doi.org/10.33904/ejfe.843964>
- Çağlar, S., (2021): Work efficiency and physical workload during the manual debarking of Scotch pine trees, *International Journal of Forest Engineering*, doi: <https://doi.org/10.1080/14942119.2021.1927471>
- Gerasimov, Y., Sokolov, A., 2014. Ergonomic evaluation and comparison of wood harvesting systems in Northwest Russia, *Applied Ergonomics*, 45 (2014) 318-338. <http://dx.doi.org/10.1016/j.apergo.2013.04.018>
- Jacke H, Noltensmeier A, Hillmer-Vogel U. 2006. Entlastung bei der Langholzbringung durch Kunststoffseile?: [Chockermen's relief at skidding purposes by using syntetic ropes?]. *Forst und Holz.* 61:141–145. (in German).
- Karvonen MJ, Kentale E, Mustala O. 1957. The effects of training on heart rate; a longitudinal study. *Ann Med Exp Biol Fenn.* 35:307–315.
- Kirk PM, Sullman MJM. 2001. Heart rate strain in cable hauler choker seter in New Zealand logging operations. *App. Ergonomics.* 32:389-398. doi:10.1016/S0003-6870(01)00003-5
- Marchi E, Chung W, Visser R, Abbas D, Nordfjell T, Mederski PS, McEwan A, Brink M, Laschi A. 2018. Sustainable forest operations (SFO): a new paradigm in a changing world and climate. *Sci Total Environ.* 634:1385–1397. doi:10.1016/j.scitotenv.2018.04.084.
- Polar. 2022. Polar RS800CX user manual. [https://support.polar.com/e\\_manuals/RS800CX](https://support.polar.com/e_manuals/RS800CX), Accessed November 14, 2022.

**Full-Paper Oral Presentations**

- Ponsse. 2022. The cut-to-length method. <https://pim.ponsse.com/media/ponsse-pim-api/api/content/getfile/16317217.pdf> Accessed November 23, 2022.
- Potočnik, I., Pentek, T., Poje, A. Severity analysis of accidents in forest operations. *Croat. J. For. Eng.*, 30 (2) (2009), pp.171-184.
- Samset, I. (1985). The Yarding Crew. In: Winch and cable systems. *Forestry Sciences*, vol 18. Springer, Dordrecht. Page:166-175, ISBN: 978-90-481-8291-6, [https://doi.org/10.1007/978-94-017-3684-8\\_10](https://doi.org/10.1007/978-94-017-3684-8_10)
- Soman H, Kiaha AR, Munoz Delgado B, Kenefic LS, Kanoti K. 2020. Production economics: comparing hybrid tree-length with whole-tree harvesting methods. *Forestry*. 93(3):389–400. doi:10.1093/forestry/cpz065.



**Abstract Oral Presentations****Evaluation of GIS-based Forest Road Route Planning Criteria in Landslide Susceptible Areas****Ender Buğday**

Çankırı Karatekin University, Faculty of Forestry, Çankırı, Türkiye  
[ebugday@karatekin.edu.tr](mailto:ebugday@karatekin.edu.tr)

---

**Abstract**

Forest roads are the basic infrastructure facilities needed in the effective management of forests. Since forests generally spread in mountainous and high sloping areas in our country, forest roads also provide basic transportation support to settlements. Planning of the forest roads is carried out depending on many factors. Forest road planning and construction should be conducted more precisely in zones of the forest that are susceptible to landslides due to altitude, slope, and similar factors. The aim of the present study is to define various factors that can be utilized for forest road planning activities in locations that need road construction and are at potential for landslides, as well as to develop a workflow for planning. The factors that are typically used in landslide susceptibility assessments and methodologies aided by Geographic Information Systems (GIS) are stated in the first stage of this study. The procedures necessary to establish the workflow are mentioned in the next step along with samples drawn from local and international literature. Revealing the planning in mountainous areas in GIS environment, multi-criteria and in more detail; although it is a more rational approach in terms of time, cost, and applicability, it provides an advantage to plan makers and decision-makers before forest road construction. With the workflow presented in this study, it is thought that an efficient planning approach will be provided by providing support to practitioners, planners, and decision-makers for forest road planning studies in landslide susceptible areas.

**Keywords:** *Forest road, Landslide susceptibility, Road planning, Planning factors*

**Abstract Oral Presentations****Regional Evaluation of Landslides between 1950-2020 in Turkiye by Trend Analysis****Anil Orhan Akay<sup>1\*</sup>, Murat Ozocak<sup>2</sup>, Abdullah İlker Esin<sup>2</sup>, Necmettin Senturk<sup>1</sup>, Mustafa Akgul<sup>1</sup>**

<sup>1</sup> Faculty of Forestry, Department of Forest Construction and Transportation, Istanbul University-Cerrahpaşa, Bahçekoy, Sarıyer, 34473 Istanbul, Turkiye

<sup>2</sup> Irrigation Technology Program, Vocational School of Forestry, Istanbul University-Cerrahpaşa, Bahçekoy, Sarıyer, 34473 Istanbul, Turkiye

\* [aoakay@iuc.edu.tr](mailto:aoakay@iuc.edu.tr)

---

**Abstract**

Many factors trigger landslides, including meteorological changes, earthquakes, volcanic activities, rises in water levels, and human activities. In addition, landslides are one of the natural geological disasters that can occur in many parts of the world, which can result in loss of life and property and environmental degradation. Therefore, studies on landslides are of great importance in terms of preventing and reducing the risk of landslides and improving disaster preparation capabilities. Turkiye is one of the countries with a high potential for landslide in terms of geographical conditions and climate characteristics. In this context, 13494 landslides occurred in Turkiye between 1950 and 2008, most of them in the Black Sea Region, and as a result, 78767 people and 7175 settlements affected. The aim of the study is to determine whether there is a temporal trend in landslide disasters at the provincial level between 1950 and 2020 in Turkiye. In this context, the number of landslides per 1000 km<sup>2</sup> for each province has been taken into account in order to eliminate the differences between the provinces due to the surface area. The results obtained will contribute to the correct execution of the disaster management processes at the provincial level by determining the landslide disaster in a temporal and spatial manner.

**Keywords:** *GIS, natural disaster, mapping, spatial analysis, risk mitigation*

---

**Abstract Oral Presentations****Investigation of the Relationship Between Landslide and Forest Roads via OpenGIS® Web Map Services (WMS)****Taha Yasin Hatay\*, Selçuk Gümüş**

Department of Forest Engineering, Faculty of Forestry, Karadeniz Technical University, Trabzon, Türkiye

\* [tyhatay@ktu.edu.tr](mailto:tyhatay@ktu.edu.tr)

---

**Abstract**

Developments in computer technology affect the forestry sector as well as many branches of science. Web-based geographic information systems have just begun to be used in scientific studies on topography. These innovations reveal the relationships between different variables. Online map systems can use databases of all forestry-related variables. These data can be designed by different stakeholders to be used by the end user. In this study, landslide areas and forest roads were used as an online map. The boundaries of Maçka State Forest Enterprise were used for the data. For forest roads data, the data of the General Directorate of Forestry was used as an online database. For landslide data, the data obtained from the General Directorate of Mineral Research and Exploration was used as an online database. Different zone areas have been created for the relationship between forest roads and landslides. Landslide areas in these zone areas have been revealed. The relationship between the zones of the forest road (platform, 100m, 250m, 500m, 1000m) and the landslide areas was investigated. There is a 0.23% landslide area in the platform zone. There is a 5.58% landslide area in the 100-meter zone. There is a 13.4% landslide area in the 250-meter zone. There is a landslide area of 24.48% in the 500-meter zone. There is 49.1% landslide area in the 1000-meter zone. The average distance of forest roads to landslide areas is 984 m. Only 8% of all landslide areas are unrelated to forest roads and are not in any zone. Forestry data can be compared with environmental factors by using MySQL, Javascript and PHP on online maps. Databases will be used more in future designs. Open-source online databases should be created. Thus, it is seen that more contributions will be made to research opportunities.

**Keywords:** *OpenGIS, Open access map, Web map, Forest road, Landslide areas*

---

**Abstract Oral Presentations****Using GIS-based MCDS methods for Generating Forest Fire Risk Maps****Abdullah E. Akay<sup>1\*</sup>, Aybike Göksu Bektaş<sup>2</sup>**<sup>1</sup> Bursa Technical University, Faculty of Forestry, Bursa, Turkiye<sup>2</sup> Karabük University, Department of Computer Engineering, Karabük, Turkiye\* [abdullah.akay@btu.edu.tr](mailto:abdullah.akay@btu.edu.tr)

---

**Abstract**

Determination of forest fire risk zones provides important contributions in minimizing fire damages and determining where the fire can start and in where it can spread. The forested areas with high fire risk can be determined depending on stand characteristics, topographical features and anthropogenic factors and they can be presented to decision makers in the form of maps. These maps can increase the effectiveness of the plans made before the fire and contribute to making the right decisions in a short time in the event of a fire. In this study, it was aimed to develop a fire risk map by integrating GIS techniques and Analytical Hierarchy Process (AHS), one of the well-known Multi Criteria Decision Support (MCDS) methods. The study was implemented in a Forest Enterprise Chief in the border of Antalya Forestry Regional Directorate where forests are mostly sensitive to forest fires at the first degree. In the study, fire risk factors included tree species, stand closure, stand age, slope, aspect, and distance to roads. The results indicated that 27% of the forested areas was within the very high-risk zone while 29% and 24% was found to be in high and medium fire risk zones, respectively.

**Keywords:** *Forest fires, Fire risk map, GIS, MCDS*

---

**Abstract Oral Presentations****Fire Susceptibility Analysis Considering its Impacts on Biodiversity of Lowland Forests in Azerbaijan****Yusif Abiyev<sup>1\*</sup>, Remzi Eker<sup>2</sup>, Ahmet Açıl<sup>3</sup>**<sup>1</sup> Botany Institute, Department of Geobotany, AZ1004, Baku, Azerbaijan<sup>2</sup> Izmir Katip Celebi University, Faculty of Forestry, Cigli Main Campus, 35620, Izmir, Turkiye<sup>3</sup> Karabük University, Faculty of Forestry, Demir Celik Campus, 78050, Karabük, Turkiye\* [yusif.abiyev@gmail.com](mailto:yusif.abiyev@gmail.com)

---

**Abstract**

Severe or irregular fires lead to disruption in soil, flora, fauna, and air of the fire-sensitive ecosystems. Mapping the fire susceptibility together with analyzing its driving factors are crucial for reducing and preventing deforestation and desertification. In recent years, the number of forest fires has been increasing in Azerbaijan. However, risk factors for fire management are not taken into account in advance. The purpose of the research is to study the risk potential of lowland forests, where most fires occur and are under the severe anthropogenic influence, and to assess the probability of damage to rare plants in the risk zone. The research area was conducted in the Samur-Yalama National Park, which was created in the last 10 years to protect the forests of the Caspian coastal plain. The most successful machine learning method- MaxEnt was applied in this study. According to the obtained results, it is successful for use in the analysis of vegetation type, understory, roads, river networks, habitats, agriculture, and fire-starting points. Areas at risk, based on where the fire started, are mainly residential areas and zones close to roads. We observed 22 plant species included in the Red Book of Azerbaijan in the risk zone.

**Keywords:** *Fire parameters, Rare plants, Machine learning, MaxEnt, Fire risk*

---

**Abstract Oral Presentations****A Spatiotemporal Analysis of Carbon Storage in Urban Ecosystem After Forest Fire****Zennure Uçar<sup>1\*</sup>, Ramazan Akbulut<sup>2</sup>, Abdullah E. Akay<sup>3</sup>**<sup>1</sup> Izmir Katip Celebi University, Faculty of Forestry, Cigli Main Campus, 35620, Izmir, Turkiye<sup>2</sup> General Directorate of Forestry, Marmara Forestry Research Institute, 34485 Istanbul, Turkiye<sup>3</sup> Bursa Technical University, Faculty of Forestry, Department of Forest Engineering, Bursa, Turkiye\* [zennure.ucar@ikcu.edu.tr](mailto:zennure.ucar@ikcu.edu.tr)

---

**Abstract**

Urban vegetation refers to all trees and shrubs that are important resources in urban environments. They provide many essential benefits to human beings, including but not limited to facilitating cooling effects, reducing energy use, improving water and air quality, providing diverse wildlife habitats, and increasing human health and well-being. In particular, they play a vital role in reducing carbon emissions in urban areas by storing carbon. Hence, quantifying above-ground carbon stored by urban trees and its distribution is essential to better understanding urban vegetation's role in urban environments. This study aimed to examine how forest fire affects the amount and distribution of stored carbon in the urban environment for the case of Marmaris fire took place in Summer 2021 in Turkiye. In the solution process, urban forest carbon storage maps were generated before and after the Marmaris forest fire using remote sensing-based methodology with freely available remote sensing (RS) data. The results pointed out that using existing methodology could be rapid and cost-effective in monitoring the carbon storage change after an anthropogenic and natural disaster. However, for precise and reliable estimation of total carbon storage and the change in total urban carbon storage, the methodology needs to be developed at a local scale using field sampling along with RS data.

**Keywords:** *Urban forest, Forest fire, Carbon storage mapping, Spatiotemporal change*

---

**Abstract Oral Presentations****Wildfire disasters in Albania as a Major Hazard to Forest Resources****Nehat Çollaku<sup>1</sup>, Elvin Toromani<sup>1</sup>, Erion Istrefi<sup>2</sup>**<sup>1</sup> Faculty of Forestry Sciences, Agricultural University of Tirana, Albania<sup>2</sup> Tirana World Bank Office, Albania\* [nehatcollaku@ubt.edu.al](mailto:nehatcollaku@ubt.edu.al)

---

**Abstract**

Forest fires pose a serious threat in Albania and cause numerous environmental and socio-economic problems. In recent years, forest fires have become an important issue in Albania and numerous efforts are focused on controlling the negative impacts. Based on the evaluation of the damage caused in the forest, it is concluded that the risk of forest fires is evaluated as a third-degree risk after the evaluation of the damage caused by human factors and climate change. This paper aims to analyze the adaptation to climate changes caused by forest fires, which starts with the assessment of forest fire risk and the identification of fire hotspots in order to take measures for the management of forest fires. Improving fire risk assessment methodology, developing technologies, and improving response structures are three prerequisites for reducing forest fire risk. Following the assessment, a strategy for managing fires at the national level will be developed, accompanied by an action plan with concrete measures to mitigate fire risk.

**Keywords:** *Wildfire, Disaster, Forest resources, Assessment, Strategy*

---

**Abstract Oral Presentations****Forest Fire Susceptibility Mapping Using Maximum Entropy Method a Case Study in the Northeast of Turkiye****Bahar Dinç<sup>1</sup>, Derya Mumcu Küçüker<sup>2\*</sup>**

<sup>1</sup> Gümüşhane University, Institute of Natural and Applied Sciences, Department of Forestry and Environmental Sciences, Gümüşhane, Turkiye

<sup>2</sup> Karadeniz Technical University, Faculty of Forestry, Department of Forest Engineering, Trabzon, Turkiye

\* [dmumcu@ktu.edu.tr](mailto:dmumcu@ktu.edu.tr)

---

**Abstract**

Forest fires have a destructive effect on ecosystems, and economies. The Northeast part of Turkiye suffers from forest fires during the last decades. The management of these catastrophes is of importance to both government authorities and the public. Therefore, modeling and mapping potential fire hazards are critical for forest fire management and prevention. The objective of this study is to generate a forest fire susceptibility map by using the Maximum Entropy (MaxEnt) method. This analysis was performed by using historical forest fire ignition points obtained from Araklı Forest Planning Unit between 2012-2022. This analysis was conducted considering the factors affecting the forest fire risk such as forest structure, environment, climate, and topography. The forest fire risk map was classified into 5 categories including very low, low, moderate, high, and very high. The area under the receiver operating characteristic curve (AUC) was used to validate the accuracy of the fire risk map. The results showed that the methodology presented a practical and effective tool to help forest fire managers and researchers for efficient management of fire risk.

**Keywords:** *Forest fire susceptibility map, MaxEnt, GIS, Validation*

---



**Abstract Oral Presentations****Determination of Post-Fire Condition with Terrestrial and Remote Sensing Techniques in Burned Young Oak Forest****İsmail Baysal\*, Remzi Eker**

İzmir Katip Çelebi University, Faculty of Forestry, Çiğli Main Campus, 35620, İzmir, Türkiye

\* [ismail.baysal@ikcu.edu.tr](mailto:ismail.baysal@ikcu.edu.tr)

---

**Abstract**

Fires are very important and wide spread disturbances for most ecosystems around the world, especially in forest ecosystems. Determination of burned areas and fire effects are very important for the management and sustainability of these ecosystems. In this study, the effects of fire were tried to be revealed in a deciduous burned oak forest with terrestrial and remote sensing techniques. Within the first stage of this study, the perimeters of the burned areas were determined precisely in the field by a GPS tool. The areas affected by the forest fires with different sizes within the burned areas were determined as polygons in digital form with terrestrial GPS measurements and mapped in GIS program. Thus, the areas affected by different fire types in different land structures were identified in details. In the second stage of this study, Sentinel-2 satellite images were used for the determination of fire severity classes with remote sensing techniques. Afterwards, determination of fire severity was compared for two methods. Study results serve to obtain reliable and fast post-fire conditions for the determination and evaluation of burned areas for rehabilitation and afforestation activities.

**Keywords:** *Forest fire, fire severity, post-fire, oak, Türkiye*

---

**Abstract Oral Presentations****Operational Planning Procedure for Salvage Harvest after Disasters****Mehmet Eker**

Isparta University of Applied Sciences, Faculty of Forestry, Department of Forest Engineering, Isparta, Turkiye  
[mehmeteker@isparta.edu.tr](mailto:mehmeteker@isparta.edu.tr)

---

**Abstract**

In parallel with climate change, various disasters/destructions are encountered on forest ecosystems. In Mediterranean countries such as Turkiye, natural or man-made forest fires; It negatively affects the forest ecosystem, forest inhabitants and forestry activities. Rapid removal of debris to restore ecosystems after such disasters; It is necessary to prepare for the supply of commercially valuable property and to re-forest the damaged areas. This process called salvage harvest, practice involves the removal of dead, dying, or deteriorating trees from a forest before the value of the wood products become worthless. Cleaning up this debris can be time-consuming and costly, extending the recovery from the disaster. Technically, these types of operations could be applied to every stand having even-aged or uneven-aged. The trees removed from the stands may be pre-commercial or elderly and therefore subject to damage imposed by by wind, fire, or other natural events. In this operation, the timing of the harvest is not consistent with the timing of a thinning or a final harvest operation. Therefore, there is a need for an operation planning in accordance with the current capacity for the effective use of time and resources. When we look at the last lessons learned from the fires that took place in the last 2 years in Turkiye and caused mass destruction in the forests; The importance of post-disaster operations for the renewal of the generation has become more understandable. In this study, it is aimed to describe how a planning procedure should be for the operations of harvesting and transporting (commercial) woody material remaining in the forest area after wind, snow or avalanche disasters, especially fire. With the operational planning approach; It is aimed at solving problems such as how sensitive data should be collected, how to derive data on available resources and capacity, how much and when these resources will be needed, and how to make conflicting, multi-purpose and multi-criteria decisions quickly and consistently.

**Keywords:** *Salvage harvest, Operational planning, Forest disaster, Debris management*

---

**Abstract Oral Presentations****Problems of Integral Assessment of Natural and Anthropogenic Origin  
Environmental Risks in Azerbaijan****Mirnuh J. Ismayilov, Emil A. Jabrayilov**

ANAS, Institute of Geography named after academician H.A.Aliyev, AZ 1143, Baku, Azerbaijan

\* [mirnuh.ismayilov@yahoo.com](mailto:mirnuh.ismayilov@yahoo.com)

---

**Abstract**

As long as we communicate or interact with all components of the environment, we are in a certain state of risk. From this point of view, determining the ecological risks and carrying out zoning for the territory of Azerbaijan is an urgent issue in the current period. In order to study the level and spread of environmental risks the field research materials of 2010-2020, as well as Landsat 7 and 8 satellite data, numerous thematic maps reflecting the ecological state of the environment, were widely used during the research. Sources of ecological risk in the territory of Azerbaijan were identified and a database was collected for the research. Based on the mentioned data, a medium-scale (1:600000) digital environmental risk map was prepared with the help of Geographical Information Systems. The risk and threat index were calculated in the studies. Landslide risk in Azerbaijan is 57% of the total area, of which 29.7% are weak, 19.8% medium, and 8.5% high landslide risk landscapes. The risk and threats caused by the flood event is typical for mountainous and foothill areas of Azerbaijan. In total, 38% of the territory of Azerbaijan is areas with different levels of flood risk. As a result of the research, 16.5% are low, 14.4% medium and 7.2% high flood risk landscapes. The analysis of the available data shows that desertification, landslides and avalanches, erosion, floods, man-made loads and earthquakes remain priority areas for the territory of Azerbaijan in terms of landscape-ecological risk.

**Keywords:** *Environmental risks, Floods, Landslides, Desertification, Erosion, Earthquake*

---

**Abstract Oral Presentations****Forest Fire Related Accidents in Turkiye****Bahar Dinç<sup>1\*</sup>, Sibel Ersoy<sup>2</sup>**

<sup>1</sup> Gümüşhane University, Institute of Natural and Applied Sciences, Department of Forestry and Environmental Sciences, Gümüşhane, Turkiye

<sup>2</sup> Gümüşhane University, Occupational Health and Safety Department, Gümüşhane, Turkiye

\* [bahardinc@gumushane.edu.tr](mailto:bahardinc@gumushane.edu.tr)

---

**Abstract**

In Turkiye, as an integral component of Mediterranean ecosystems, about 60 percent of the forests are endangered by the fire danger. Forest fires happen often and the loss is very serious each year. The one of the worst consequences of forest fires is the lives lost of civilians and forest firefighting crews, even some fire managers. From 1937 to 2018, massive wildfires occurred principally in Turkiye caused fatal accidents and a badly injured survivor. The most of them are firefighters and others are forest fire managers and civilians. In this paper, statistical data on forest fire accidents in Turkiye are analysed in order to reveal the features regarding occupational health and safety of the forest fires. In order to explain what had happened in forest fire accidents and why experienced fire fighters and managers lost their life, the semi-structured interviews were held with forest firefighting crews, researchers, managers and experts from various fields. The findings from the interviews and past forest fire accidents indicated local knowledge and understanding fire behaviour are very important to assist firefighters and other people to save their life. That is, the occupational health and safety in the forest fires should be defined and evaluated by domain experts. This research contributes to firefighter training and fire managers by exploring the lessons learned from the cases and facts in the past have helped to develop occupational health and safety for forest fires that are now introduced almost universally.

**Keywords:** *Firefighters, Forest fire, Fire safety, Turkiye*

---

**Abstract Oral Presentations****Analyzing Landslide Susceptibility of Forest Roads by Analytical Hierarchy Process (AHP)****Derya Mumcu Küçüker**

Karadeniz Technical University, Faculty of Forestry, Department of Forest Engineering, Trabzon, Türkiye  
[dmumcu@ktu.edu.tr](mailto:dmumcu@ktu.edu.tr)

---

**Abstract**

The landslide phenomenon is one of the most damaging disasters. Especially in the Black Sea Region of Türkiye, they can destroy natural resources and constructions such as forest roads and also cause serious maintenance costs due to the degradation of roadbeds. Mapping potential landslide risk in forested areas is very helpful for road planning and determining preventive measures in case of landslides. In this study, a landslide susceptibility map was generated by the Analytical Hierarchy Process and Geographic Information Systems (GIS) in the Of Forest Planning Unit, Trabzon based on land use, lithology, elevation, slope, aspect, topographic wetness index, distance to streams, distance to roads, and distance to faults. The estimated risk map was divided into 3 classes of susceptibility as low, moderate, and high. To identify the potential landslide risk of existing forest roads, the existing forest roads layer and created landslide map were overlaid. The results showed that a significant amount of the current forest roads is highly prone to landslide risk. The area under the curve (AUC) of the Receiver Operating Characteristic (ROC) based on landslide locations occurred in the past was used for validation of estimated map. LSM provide precise information for planners and decision-makers to obtain landslide risk; hence, it can be used for planning of forest road network and reduce the potential risk.

**Keywords:** *GIS, Landslide Susceptibility Map, AHP, Validation, Forest roads*

---

**Abstract Oral Presentations****Evaluating the Design and Construction of Forest Roads in Landslide-Prone Areas Using Machine Learning and Remote Sensing Techniques****Sebahattin Açıkgöz\*, Abdullah E. Akay**

Bursa Technical University, Faculty of Forestry, Department of Forest Engineering, Bursa, Türkiye

\* [sebahattin.acikgoz@csb.gov.tr](mailto:sebahattin.acikgoz@csb.gov.tr)

---

**Abstract**

With the effect of global climate change, the amount of instantaneous precipitation in the world is increasing. Accordingly, there is an increase in landslide events in areas where instantaneous precipitation amounts increase, the clay content in the soil structure is high and the ground slope is steep. In addition to their destructions in city centers, these landslides also destroy the forests in upper watersheds. It is also observed that the mass movements can move towards the lower basins with the effect of rainwater and cause a chain of disasters that trigger each other. With these devastating effects, the protection of forest resources is gaining importance day by day. The locating and maintaining forest roads are key actions to conduct the forestry activities such as afforestation, harvesting, transportation, firefighting, maintenance, and protection, however forest roads may trigger landslides during and after the construction process if suitable technics are not implemented. Since forest road construction requires heavy machine works in forests and involves direct intervention in the ecological balance of nature, it is inevitable that they will negatively affect the forests. Since these roads are the basic facilities for the execution of forestry activities, the forest road construction activities should continue despite their potential damages. At this point, to minimize these effects, it is necessary to design an optimum forest road network based on computer-based methods and make rational planning. In this framework, it becomes essential to benefit from advanced technology such as machine learning and remote sensing technologies to find the best solutions. This paper evaluates the capabilities of using machine learning and remote sensing techniques in designing and constructing forest roads particularly in landslide-prone areas based on the previous studies conducted in the subject.

**Keywords:** *Forest road planning, landslide, machine learning, remote sensing*

---

**Abstract Oral Presentations****Comparison of Hand-Held Mobile Laser Scanning and Terrestrial Photogrammetry for 3D Modelling of Post-Wildfire Erosion Plots****Ahmet Aıl<sup>1\*</sup>, Remzi Eker<sup>2</sup>, Ahmet Duyar<sup>1</sup>, Abdurrahim Aydın<sup>3</sup>**<sup>1</sup> Karabük University, Faculty of Forestry, Demirelik Campus, 78100, Karabük, Turkiye<sup>2</sup> İzmir Katip elebi University, Faculty of Forestry, iđli Main Campus, 35620, İzmir, Turkiye<sup>3</sup> Düzce University, Faculty of Forestry, Konuralp Campus, 81620 Düzce, Turkiye\* [ahmetacil@karabuk.edu.tr](mailto:ahmetacil@karabuk.edu.tr)

---

**Abstract**

One significant effect of wildfires that have increased in frequency and severity due to climate change and human activities is soil erosion. Wildfires convert the soil more prone to erosion regarding post-fire conditions, especially in mountainous regions where forests are located. In literature, numerous investigations on the effects of wildfire on erosion processes have been conducted. Within this context, different remote sensing techniques have also been studied recently. This study aimed to create 3D models of erosion plots installed in a catchment affected by a fire event that occurred in June of 2022 in the Argavlı locality of Germencik district (Aydın city, Turkiye) with two remote sensing techniques: a hand-held laser scanning (HMLS) and a close-range terrestrial photogrammetry (CRTP). The objective was to evaluate both methods comparatively in terms of their advantages and disadvantages. This study proposed that both techniques are suitable for small-scale studies and can be used effectively in modelling erosion plots. Although the data acquisition technique with HMLS is faster than CRST, it is more costly. Also, the HMLS used in this study did not have the capability of collecting point clouds with true colors. The main problem in CRTP could be taking images in the correct directions.

**Keywords:** *CRTP, Erosion Plot, HMLS, Wildfire*

---

**Abstract Oral Presentations****Using GIS Techniques for Investigating the Optimum Locations for Fire Watchtowers****Halit Büyüksakallı<sup>1\*</sup>, Abdullah E. Akay<sup>2</sup>**<sup>1</sup> Muğla Sıtkı Koçman University, Department of Forestry, Köyceğiz Vocational School, Muğla, Türkiye<sup>2</sup> Bursa Technical University, Faculty of Forestry, Bursa, Türkiye\* [halitb@mu.edu.tr](mailto:halitb@mu.edu.tr)

---

**Abstract**

The construction of forest roads is very important in terms of putting forests into operation and providing access to forests in case of disasters. With the increase in climate change, the increase in the number of years in which the risk of fire is high, the prolongation of the fire season, and the effect of the fires on larger areas increase the importance of forest roads. In this study, the Cokertme neighborhood within the borders of the Milas Forestry Management Directorate, which was highly affected by the fire that destroyed 12764 ha of forest area in 2021, was chosen as the study area. Analyzes were made on Sentinel-2 satellite images before and after the fire in the study area. An area of 1995.35 ha where the effect of the fire was seen on these satellite images was determined as the study area. The forest cover and forest roads in this area were digitized and the situation before and after the fire was determined. While there were 50.13 km of roads in the area before the fire, the number of roads after the fire was found to be 88.85 km. The road density in the area was determined as 31.5 m/ha. Although the forest road density is higher than desired, it is concluded that the reason why the fire is so effective in the area is that the roads are not homogeneously distributed over the area.

**Keywords:** *Forest roads, Forest fire, Sentinel-2, ArcGIS, Satellite images*

---



**Abstract Oral Presentations****Wind-driven Fires in Northeastern Turkiye****Bahar Dinç<sup>1\*</sup>, İsmail Baysal<sup>2</sup>**

<sup>1</sup> Gümüşhane University, Institute of Natural and Applied Sciences, Department of Forestry and Environmental Sciences, Gümüşhane, Turkiye

<sup>2</sup> İzmir Katip Çelebi University, Faculty of Forestry, Department of Forest Engineering, İzmir, Turkiye

\* [bahardinc@gumushane.edu.tr](mailto:bahardinc@gumushane.edu.tr)

---

**Abstract**

Forest fire extinguishing is often very challenging for forest managers, particularly for large and quickly spreading fires close to home and communities. On the other hand, the situations leading to these 'hazardous' fires are poorly understood in North-eastern **Karadeniz-Black Sea** Region. In this study were analyzed fire records and interviews of firefighters and managers over the last 20 years in Trabzon Forest Regional Directorate of north-eastern Turkiye and survey the weather conditions that caused catastrophic fires, fast-growing fires and fires that are conducive to fall into the trap. Here, a quantile regression model was used for testing the effect of weather conditions on different fire sizes. The results show that strong winds drive the largest fires everywhere where meets fine fuels on the surface. The main cause of fires in that region are stubble burnings, are intentionally setting fire to the straw stubble that remains after agricultural activity, like hazelnut, tea plant, etc., have been harvested. Besides, forceful winds also drive entrapments whereas low relative humidity excites rapidly spreading fires. This impresses on that wind-driven fire are the irruptive pattern of hazardous fires in North-eastern **Karadeniz-Black Sea** Region, however it yields that large 'catastrophic' fires can also appear to pose a serious danger. Recognizing fire weather conditions that drive 'hazardous' wildfires will provide useful information for fire managers to better estimate for changes in fire behaviours.

**Keywords:** *Forest fires, Wind-driven fires, Quantile regression, Stubble burnings, Strong wind.*

---

**Abstract Oral Presentations****Visibility analysis of fire lookout towers: The Case of Edremit State  
Forest Enterprise in Turkiye****Burak Sari\*, Derya Mumcu Küçüker**

Karadeniz Technical University, Faculty of Forestry, Department of Forest Engineering, Trabzon/Turkiye

\* [buraksari@ktu.edu.tr](mailto:buraksari@ktu.edu.tr)

---

**Abstract**

Forest fire is one of the most important factors that affect forest ecosystems. Turkiye, which is in a sensitive location for forest fires, continues its fight against forest fires effectively. In this fight, fire lookout towers, which enable forest fires to be detected early stage and necessary interventions to be made, also have an important contribution. Workers in the fire lookout tower try to observe any forest fire indication and direct them to fire-fight teams immediately. Therefore, the effectiveness of the fire lookout tower is very important to be able to respond to a fire as soon as possible. For this purpose, visibility analysis of fire lookout towers was determined using ArcGIS software and the percentage of visible and unvisitable areas was determined for Edremit State Forest Enterprise in Balıkesir, Turkiye. The results showed that visibility analysis is a very useful and practical method for the evaluation of current fire lookout towers and determining the potential location of fire lookout towers.

**Keywords:** *Visibility analysis, GIS, Fire lookout towers*

---

**Abstract Oral Presentations****Importance of Forest Road Networks in Forest Firefighting Activities****Hajri Haska**

Department of Forestry, Faculty of Forest Sciences, Agricultural University of Tirana, Albania

[hhaskaj@ubt.edu.al](mailto:hhaskaj@ubt.edu.al)

---

**Abstract**

Forest fires damage an average of four million hectares of forest area in the world and 550,000 hectares of forest area in the Mediterranean basin. Albania is subject to devastating wild fires in recent years especially during the peak fire season of July-October. Efforts to combating forest fires are of great importance in reducing possible losses due to forest fires. In order to be able to respond effectively to forest fires, especially in fire-sensitive areas, the transportation time of the ground team should not exceed the critical response time, when the fire is more likely to be brought under control. It is necessary to determine the areas that can be reached by the ground team moving from the fire stations within the critical response time. GIS-based decision support systems are utilized to improve the efficiency of fire management stages. Advances in computer technology and GIS techniques made it possible to use network analysis method in ArcGIS. In this study, it was aimed to investigate the importance of forest roads in forest firefighting activities considering the accessed forest areas by the ground team in the critical response time.

**Keywords:** *Forest fires, Forest roads, Shortest path, Network analysis, GIS*

---

**Abstract Oral Presentations****The Effect of Spatial and Temporal Variation of Land Use Change on Some Soil Properties in Mediterranean Karst Ecosystems****Turgay Dindaroglu<sup>1\*</sup>, Bilal Boran<sup>2</sup>, Emre Babur<sup>3</sup>, Oleksandr Menshov<sup>4</sup>**<sup>1</sup> Karadeniz Technical Imam University, Faculty of Forestry, 61050, Trabzon, Turkiye<sup>2</sup> General Directorate of Forestry, Adana Regional Forest Directorate, Karaisali, Turkiye<sup>3</sup> Kahramanmaras Sutcu Imam University, Faculty of Forestry, Kahramanmaras, Turkiye<sup>4</sup> Taras Shevchenko National University of Kyiv, Institute of Geology, Kyiv, Ukraine\* [turgay.dindaroglu@ktu.edu.tr](mailto:turgay.dindaroglu@ktu.edu.tr)

---

**Abstract**

The negative joint effects of deforestation and global climate change, which interact with each other, are becoming more drastic. This study was carried out to examine the changes in some soil properties of the lands that were removed from the forest regime 30 years ago and converted to agricultural use by the 2/B article in Forest Law No. 6831 in ten different forest villages in Adana, Turkiye. A total of 90 soil pits were dug up from the forest (F), Converted to Cropland (CC), and agricultural (C) areas adjacent to each other in ten different villages. A total of 180 disturbed and 180 undisturbed soil samples were taken from the soil profile from two depth levels (0-30 cm, and 30-60 cm). Grain size distribution (texture), organic matter content (OM), dispersion ratio (DO), bulk weight (BD), soil reaction (pH), electrical conductivity (EC), total nitrogen (TN), grain density (GD), pore volume (PR), total lime content (L), field capacity (FC) wilting point (WP) available water content (AWC) and soil moisture (SM) analyzes were performed on the soil samples. According to the data obtained from the top soils of the study area, the organic matter content was 5.31% in forest soils, 2.78% in converted to cropland soils, and 2.65% in agricultural soils; the total nitrogen content was determined as 0.14% in forest soils, 0.10% in CC and C soils. In addition, as a result of statistical analysis, a significant difference was found in OM, BD, GD, PR, TN, and AWC values in the F, CC, and C soils in the topsoil (0-30cm). It has been determined that the lands converted from degraded forest areas to agricultural lands 25 years ago are in the form of a gateway between forest lands and ancient agricultural areas in the same area. A sustainable ecosystem depends on sustainable soil management. For this, optimal land use should be planned with applicable management principles by making land capability classification.

**Keywords:** *Land use, Land degradation, Soil, Karst ecosystem*

---

**Abstract Oral Presentations****Assessment of Particulate Matter Risk in Post-Fire Logging Operations****İnanç Taş\*, Abdullah E. Akay**

Department of Forest Engineering, Faculty of Forestry, Bursa, Türkiye

\* [inanc.tas@btu.edu.tr](mailto:inanc.tas@btu.edu.tr)

---

**Abstract**

There are different studies investigating the effect of forest fires on air quality. Smoke and ashes from burnt materials and smaller particulate matter generated during fire cause serious amount of air pollution. On the other hand, after the forest fire occurrence, a significant amount of ash formation is observed on the fire-damaged wood raw material, other burned materials or on the ground cover. Several studies have investigated the various effects of fires on air quality or forest soil. The subject of this study is to examine the effects of particulate matter that may occur during post-fire logging operations on workers' health. A significant amount of particulate matter is formed during logging activities due to movements of the logging machines and wood raw materials on the ground. Therefore, when the post-fire logging operations are taken into account, particulate matter consisting of burnt wood raw material and ashes need to be considered. It is predicted that these substances will mix with the air during timber extraction and be inhaled by the forestry workers, which will cause various health problems. In terms of workers' health, it is a very important issue to evaluate the effects of the particulate matter that will be formed due to the high amount of carbon in the burned wood raw material and the fact that it can easily turn into dust. In this study, particulate matter exposed by the forest workers was evaluated by considering the previous studies and particulate matter risk was revealed in post-fire logging operations.

**Keywords:** *Forest Fire, Particulate matter, Risk assessment, Post-fire logging*

---

**Abstract Oral Presentations****Evaluation of the Effect of Stabilization Techniques on Forest Road Cut slopes: A Review****Kıvanç Yüksel<sup>1\*</sup>, Neşe Gülci<sup>1</sup>, Abdullah E. Akay<sup>2</sup>**<sup>1</sup> Kahramanmaraş Sutcu Imam University, Faculty of Forestry, Department of Forest Engineering, Kahramanmaraş, Türkiye<sup>2</sup> Bursa Technical University, Faculty of Forestry, Department of Forest Engineering, Bursa, Türkiye\* [kyuksel@ksu.edu.tr](mailto:kyuksel@ksu.edu.tr)

---

**Abstract**

Forest road construction is one of the factors affecting the hydrological processes in forests. The forest roads consist of four segments: road surface, ditch, cut and fill slope. The segments of the roads are important structures as they effect the sediment yield from forest road sections. The cut and fill slopes with steep slopes and barren surfaces are among the most sensitive segments of forest roads in terms of sediment yield. In this study, previous studies conducted on forest road related sediment yield were discussed in order to evaluate the stabilization techniques and their effectiveness particularly in forest road cut slopes. Within this scope, scientific researches conducted in different countries were evaluated. Approximately half of the reviewed scientific papers consist of researches conducted in the last five years. Hence, we can understand the importance of slope stabilization, especially for forest roads, and that it will solve a serious ecological problem. Stabilization of the road slopes, reducing the maintenance and repair costs of the roads, providing ecological adaptation by planting the slopes with natural vegetation and giving the roads an important aesthetic feature in terms of the visual quality of the vegetated road slopes; it contributes to different economic, ecological and aesthetic functions for forest roads. The suitability of the stabilization technique to be applied on road slopes is of great importance in ensuring the success of stabilization. It is also important to determine the stabilization technique suitable for the site in stabilizing the road slopes. Slope stabilization techniques should be planned and applied to the site immediately after road construction is completed as most of the sediment yield from road slopes occurs in the first few years. In the literature review, it was concluded that the stabilization techniques applied to the road slopes play important role reducing the sediment yield compared to the untreated control plots. Generally, the use of natural materials such as geotextiles, planting methods and wood production residues were preferred as stabilization techniques in the literature studies. These methods have the characteristics of being organic plant content and enriching the soil in terms of organic matter when they decompose. In addition, being economical methods suitable for forest road costs is one of their important features. As a result, it can be concluded that biotechnical stabilization techniques with the use of biological and technical methods provide better results in terms of slope stabilization.

**Keywords:** *Forest roads, Slope stabilization, Cut slopes, Sediment yield*

---

**Abstract Oral Presentations****Quantity and Type of Logging Residues Following Cut-to-Length and Full-Tree Salvage Logging Systems in Damaged Mountain Forests****Alberto Udali\*, Lorenzo Garollo, Raffaele Cavalli, Stefano Grigolato**

Department of Land, Environment, Agriculture and Forestry, Università degli Studi di Padova, Italy

[\\*alberto.udali@unipd.it](mailto:alberto.udali@unipd.it)

---

**Abstract**

Salvage logging operations usually leave behind a considerable mass of residues or deadwood, fundamental for the ecosystem to maintain soil fertility and facilitate the establishment of regeneration and the reconstitution of new forest. This study aims to estimate the amount of deadwood released after the operations characterized by two different logging systems: Cut-to-length (CTL) and Full-Tree system (FT). Moreover, also the carbon and nutrient content of the deadwood was investigated and their interaction with the soil organic layer. Deadwood in the areas logged was sampled using linear transects. The collected data were divided into diameter class and the quantity of residues was estimated using the Brown method for fine wood debris (FWD) and the Van Wagner method for coarse wood debris (CWD). A higher amount of FWD was observed in the yards cleared with the FT system and a higher quantity of CWD in the yards logged with the CTL system. The chemical analysis of the carbon and nutrient components of the soil and deadwood samples revealed a higher amount of carbon stored in 10 cm of soil (up to 85 Mg C/ha), compared to deadwood (up to 29 Mg C/ha).

**Keywords:** *Forest harvesting, Cut-to-length, Full-tree, Salvage logging*

---

**Abstract Oral Presentations****The Future and Social and Environmental Aspects of Industrial Greening of Akmola Region in Kazakhstan****Dani Sarsekova\*, Aiman Shaldybayeva**

Department of Forest Resources and Forestry, Kazakh Agrotechnical University named after. S. Seifullin,  
Zhenis Avenue 62, Astana, Kazakhstan

[\\*dani999@mail.ru](mailto:*dani999@mail.ru)

---

**Abstract**

Modern industrial environment is a complex, open, dynamic artificial-natural system. The peculiarity of this powerful system is that it becomes a factor affecting both natural systems and people. There are different micro and mesoclimatic features. Industrial construction leads to the reduction of the area of plant cover, as well as filling these areas with artificial, often impermeable and heat-collecting materials. In recent years, scientists have been actively and comprehensively studying the environmental condition of plantations in large cities as one of the factors for improving the quality of the industrial environment. In addition, there are very few scientific works related to the problems of industrial gardening. Unfortunately, the data on the condition of tree plantations and landscaping in many regions, in particular, in the industrial areas of Akmola region, so far are approximate or of a local nature. Thus, the relevance of studying the state of industrial gardening in Akmola region is related to the impact on the environmental conditions of the industrial environment, the need for inventory and passporting of plantations; Industrial environments are defined by the search for practical solutions for various aspects of green construction. When studying the condition of the industrial environment of Akmola region, it is necessary to rely on the experience gained during the study of large industrial centers.

**Keywords:** *Social aspects, Environmental Aspects, Industrial Greening, Akmola*

---