

---

---

# Proceedings of Joint Regional Meeting of IUFRO RG3.03.00 and RG3.06.00 in Asia

---

---

“Productivity and Safety of Final Cutting on Mountain Forests”

Matsuyama and Kochi, Japan  
24th-28th July 2017

Organized and hosted by:

Ehime University

Kochi University



Supported by

IUFRO Division 3 - Forest Operations Engineering and Management

The Japan Forest Engineering Society



ISBN 978-4-9906725-1-5



**Proceedings of  
Joint Regional Meeting of IUFRO RG3.03.00 and  
RG3.06.00 in Asia**

“Productivity and Safety of Final Cutting on Mountain Forests”

Matsuyama and Kochi, Japan  
24th-28th July 2017

Organized and hosted by:  
Ehime University  
Kochi University

Supported by  
IUFRO Division 3 - Forest Operations Engineering and Management  
The Japan Forest Engineering Society

Joint Regional Meeting of IUFRO RG3.03.00 and RG3.06.00 in Asia  
Matsuyama and Kochi, Japan: 24th-28th July 2017

Editors:

Yozo Yamada  
Sub-course on Forest Environment Management  
Graduate School of Agriculture  
Ehime University

Yasushi Suzuki  
Faculty of Agriculture and Marine Science  
Graduate School of Integrated Arts and Sciences  
Kochi University

Layout: Y. Yamada, Y. Suzuki

Cover image: Y. Suzuki

Citation recommendation:

Y. Yamada, Y. Suzuki (2017) Productivity and Safety of Final Cutting on Mountain Forests.  
Proceedings of Joint Regional Meeting of IUFRO RG3.03.00 and RG3.06.00 in Asia. Matsuyama  
and Kochi, Japan 24th-28th July 2017. 297p.

The contributions are not refereed, and many of these papers represent reports of continuing  
research. It is expected that some of them will appear in a more polished and complete form in  
scientific journals.

Published by:

IUFRO RG3.03  
Graduate School of Agriculture  
Ehime University  
3-5-7 Tarumi, Matsuyama, Ehime 790-8566, Japan  
TEL & FAX: +81-89-946-9665  
E-mail: yamada.yozo.fi@ehime-u.ac.jp

Copyright © 2017 by the Authors, IUFRO RG3.03.00 and RG3.06.00  
ISBN 978-4-9906725-1-5

## **PREFACE**

Forest operations in mountain forests need to apply production systems which are adapted to specific local conditions and existing infrastructure, while minimizing negative externalities to the environment and society, such as soil, water, greenhouse gas emissions, visual impacts, wildlife, and other ecosystem services. In the meantime such production systems must concern the productivity of the operations and the impacts on safety and health of the operators. In the mountainous areas, productivity and safety are important issues because motor manual felling is still required in many conditions and especially in difficult terrain accidents occur frequently. Also the most advanced systems based on the cable-harvester cannot be considered safe enough because of the uncertainty of the anchors based on stumps or standing trees.

For what it concerns the yarding operations, mountain forests represent a demanding sector in which the slope of the terrain and the mass of the material to be transported can influence both the productivity and the work safety. Cable transportation systems on one hand offer different solutions to be implemented under different conditions, but on the other hand they can enhance the risk of accident because of the tensions applied to the cables and the use of biological elements (stumps and trees) as supports and anchoring devices.

The Joint Regional Meeting between IUFRO RG3.03.00 and RG3.06.00 will be held aiming to exchange mutual recent research achievements and information, and discuss mountain logging operations in the future considering operation techniques and ergonomic and the possibility to improve both working productivity and safety of final cutting on mountainous forests. During the meeting the participants will visit a felling site in Ehime prefecture in which winching operations are based on high-density forest road network, and other felling sites in Kochi prefecture in which material is transported through the H type cable system and an Austrian tower yarder.

The Joint Regional Meeting has a close relation to the third theme (Forests and Forest-based Products for a Greener Future) of the IUFRO strategy; it also shows some relationship with the first theme (Forests for People).

Coordinator of IUFRO RG3.03.00: Prof. Dr. Yozo Yamada  
Coordinator of IUFRO RG3.06.00: Prof. Dr. Raffaele Cavalli

## CONTENTS

PREFACE .....	i
GREETINGS .....	1
Opening Ceremony: 24th July 2017 .....	3
Closing Ceremony: 28th July 2017 .....	11
I. KEYNOTE SPEECHES .....	21
O-01: North American Trajectories of Development in Final Harvests <i>Garland, J.J.</i> .....	23
O-02: Steep Terrain Forest Operations – Challenges, Technology Development, Current Implementation, and Future Opportunities <i>Cavalli, R. and Amishev, D.</i> .....	41
II. ORAL PRESENTATIONS .....	51
Session 1	
O-03: Productivity of a Harvesting Operation for a Small Clear Cut Block by Direct Grappling using a Harvester in the Kochi University Forest <i>Suzuki, Y., Kusaka, H., Yamaguchi, Y., Aoki, H., Hayata, Y. and Nagai, H.</i> ....	53
O-04: Productivity and Harvesting of Exotic Tree Plantations on Highland in Chiang Mai, Thailand <i>Suanpaga, W, Kaakkurivaara, N., Prasanai, K., Tuankrua, V. and             Thueksathit, S.</i> .....	59
O-05: Forwarding Operation Using a Tractor and a Trailer in Mountainous Forest <i>Iwaoka, M., Suzuki, Y. and Matsumoto, T.</i> .....	65
Session 2	
O-07: A New Small Yarding System for Log Transportation <i>ACAR, H.H.</i> .....	71

O-08: The Limits and Possibilities of Japanese Swing Yarders in Comparison with European Cable Systems <i>Yoshimura, T., Suzuki, Y., Sawazaki, M., Chihara, T. and Acar, H.H.</i> .....	78
O-09: Developing Accessibility Measurement Tool between Forests and Woody Biomass Plants Using Google Maps API <i>NAKATA, C. and ITAYA, A.</i> .....	84
O-10: Physiological Inputs in Cable Yarding Operations <i>Proto, A.R. and Zimbalatti, G.</i> .....	90
Session 3	
O-11: Risk Perception and Work Safety Behavior of Indonesian Chainsaw Operators <i>Yovi, E.Y.</i> .....	97
O-12: Analysis of Work-Related Injuries of Felling Work using Chain Saws in Japan <i>Tobita, K. and Nitami, T.</i> .....	103
O-13: ICT Assistance and Management for Manual Chainsaw Operation <i>NITAMI, T. and SUK, S.</i> .....	111
O-14: Physical Effects of Hinge Shape on Chainsaw Felling Direction in <i>Chamaecyparis obtusa</i> <i>Nagao, M. and Yamada, Y.</i> .....	115
III. POSTER PRESENTATIONS .....	127
P-01: Estimation of Forest Workers Environment under the Climate Change <i>ITAYA, A.</i> .....	129
P-02: Method for Determining Felling Directions to Prevent Damage to Saplings <i>Shirasawa, H., Otsuka, D. and Saito, M.</i> .....	134
P-03: Study on Prediction of Sapling Damage Area by Felling and Skidding <i>Otsuka, D., Saito, M., Matsunaga, H. and Ueki, T.</i> .....	139
P-04: Muscle Load, Heart Rate, and Change in Body Temperature Associated with Tree Felling Work Using a Chainsaw as Revealed by Motion Analysis <i>KAMEYAMA, S., YOSHIOKA, T. and INOUE, K.</i> .....	146

P-05: Effects of Final Cutting as a Preventive Measure of Pollinosis and the Tama Timber Certification System on the Local Logging System and Productivity <i>KAMEYAMA, S., YOSHIOKA, T. and INOUE, K.</i> .....	155
P-06: Analyses on Economic Balances of Clear Cutting and Regeneration Operations in the Northern Area of Tochigi Prefecture, Japan <i>Aruga, K., Akaguma, E., Fujimaki, S., Yamamoto, T. and Okuyama, T.</i> .....	163
P-07: Productivity of Final Cutting in <i>Chamaecyparis obtusa</i> Dominated Shelterwood Stands -A Case of KANAZAWA YAMA National Forest- <i>Matsui, M., Saito, M., Otsuka, D., Matsunaga, H. and Ueki, T.</i> .....	170
P-08: The Tokyo Metropolitan Government Final Cutting Project <i>Kawase, M.</i> .....	176
P-09: Factor of Illegal Logging through Villagers Perspectives: A Case Study in Permanent Reserve Forest Ulu Sat, Kelantan, Peninsular Malaysia <i>Mohamad Amran, N.A., Hassan Zaki, P., Ismail, M.H., Wan Zee, W.N.F., Syuhada Nawli, N., Md. Sairi, Md.D. and Baharom, N.A.</i> .....	181
P-10: Long-Term Wood Supply Planning using Precise Forest Information <i>Hasegawa, H., Shirasawa, H., Okada, H., Suzuki, H., Sakaguchi, S. and Nakane, T.</i> .....	187
P-11: Productivity of Logging Large-Diameter and Long Logs for Final Cutting in a Moderate Mountain Forest <i>Nakazawa, M., Yoshida, C., Sasaki, T., Taki, S., Uemura, T., Ito, T., Yamaguchi, H., Mozuna, M., Usui, K., Iomata, Y., Suzuki, H., Yamaguchi, S., Muneoka, H., Tanaka, Y., Jinkawa, M., Zushi, K. and Aiura, H.</i> .....	195
P-12: Improving Forestry Strip Roads and Assessing the Possible Introduction of Logging Operation Systems <i>Yamasaki, S., Yamasaki, T., Suzuki, Y., Mitani, Y., Morimoto, M. and Nagasawa, Y.</i> .....	202
P-13: The Effects of Compaction on Operation Road at the Constructing <i>Matsunaga, H., Saito, M., Sugimori, S., Otsuka, D., Ueki, T., Suzuki, H., Yamaguchi, S., Muneoka, H., Tanaka, Y., Ito, T. and Inomata, Y.</i> .....	208
P-14: Moso Bamboo Strip Bundles for Surface Drainage of Slippery Roads <i>YAMAGUCHI, S., SUZUKI, H., MUNEOKA, H., TANAKA, Y. and JINKAWA, M.</i> .....	214
P-15: Evolution of Forest Harvesting in Peninsular Malaysia <i>Mohd Hasmadi, I. and Pakhriazad, H.Z.</i> .....	222



P-16: Trend of Charcoal Production from Year 2000 To 2013 from Mangrove Forest Reserve, State of Perak, Malaysia <i>Nor Azmi, B., Pakhriazad, H.Z., Mohd Hasmadi, I., Md. Damiri, M.S., Wan Nur Farinie, W.Z., Nur Syuhada, N. and Nur Afifah, M.A.</i> .....	240
P-17: Rigging methods of Simple Logging Cable Systems for Small-scale Forestry <i>Aoki, H., Suzuki, Y., Yoshimura, T., Yamasaki, S. and Yamasaki, T.</i> .....	247
P-18: Availability of Small-Scale Woody Biomass Power Generation from the View of Forest Resources in Tochigi Prefecture, Japan <i>Yamamoto, T., Aruga, K. and Shirasawa, H.</i> .....	253
P-19: An Optimum Size of Slash Pile for a Grinding Operation -Modeling the Operations of a Grapple Excavator and a Horizontal Grinder- <i>Yoshioka, T., Kameyama, S., Inoue, K. and Hartsough, B.</i> .....	259
P-20: Effect of Variation of Canopy Openness after Thinning Understory Vegetation <i>Watanabe, Y., Ochi, Y. and Suzuki, Y.</i> .....	265
P-21: The Temiar Community in Kelantan, Peninsular Malaysia: Their Socioeconomic and Culture Values <i>Wan Nur Farinie, W.Z., Pakhriazad, H.Z., Mohd Hasmadi, I., Nur Syuhada, N., Nur Afifah, M.A., Md Damiri, M.S. and Nor Azmi, B.</i> .....	273
P-22: Managing of Malaysian Tropical Rainforest: Issues and Challenges <i>Md Damiri, M.S., Pakhriazad, H.Z., Mohd Hasmadi, I., Paiman, B., Wan Nur Farinie, W.Z., Nur Syuhada, N., Nor Azmi, B., Nur Afifah, M.A.</i> .....	279
P-23: Impact on Skyline and Lifting Line during Cable Yarding <i>UENOHARA, M., MATSUMOTO, T. and IWAOKA, M.</i> .....	286
P-24: Ground pressure Distribution of Forest Machines <i>Muneoka, H., Suzuki, H., Yamaguchi, S., Inomata, Y., Sasaki, T. and Yamashita, S.</i> .....	292



# **GREETINGS**

Joint Regional Meeting of IUFRO RG3.03.00 and RG3.06.00 in Asia  
Matsuyama and Kochi, Japan: 24th-28th July 2017

## **Opening Ceremony: 24th July 2017**

Joint Regional Meeting of IUFRO RG3.03.00 and RG3.06.00 in Asia  
Matsuyama and Kochi, Japan: 24th-28th July 2017

## **Greetings to Participants of Joint Regional Meeting of IUFRO RG3.03.00 and RG3.06.00 in Asia**

Thank you all for coming and joining the academic meeting in Matsuyama and Kochi, Japan. On behalf of the host university, as dean of Graduate School of Agriculture Ehime University, I am delighted to welcome you to this Joint Regional Meeting of IUFRO RG3.03.00 and RG3.06.00 in Asia. I congratulate Professor Yozo Yamada, IUFRO RG3.03.00 coordinator, and Professor Raffaele Cavalli, IUFRO RG3.06.00 coordinator for organizing this Joint Regional Meeting in Asia.

There are two historical wood timber constructions in Matsuyama. One is Dogo Onsen, which is the oldest hot spring in Japan. The other is Matsuyama Castle which is built in Edo era, more than 400 years ago. You can see the traditional, excellent Japanese carpenter's work. Don't miss it!

I wish all participants to interact and develop international cooperation and fruitful work.

Masatoshi Sugimori

Dean, Graduate School of Agriculture Ehime University

Dean of Agriculture, Ehime University

## **GREETINGS**

Distinguished guests,  
Ladies and Gentlemen,

It is a great pleasure to have an opportunity to speak on behalf of the Forestry Agency of Japan at the Joint Regional Meeting of IUFRO in Asia.

First of all, I would like to extend my sincere congratulations on the opening of this Joint Regional Meeting and to heartily welcome all the participants from across the world.

In Japan, forests resources, especially those forests planted after World War II, have grown mature, and are now fully ready for harvest. It is our challenge to efficiently utilize the rich forest resources in order to transform forestry into a “growth industry,” while ensuring that these forests are properly managed and the resources are sustainably utilized on a cyclical basis.

To this end, the Forestry Agency has developed the new “Forest and Forestry Basic Plan” in June 2016 as a guideline for future policy measures on forest and forestry. We have also developed a new legal framework, including by the revision of the Forest Act and other relevant acts, in order to establish a stable supply system of timber and ensure reforestation after regeneration cutting in a comprehensive manner.

With such initiatives, we are committed to promoting a wide range of policy measures. Those measures include; consolidating forest practices; developing forest inventory information with ICT; developing forestry road network; producing logs efficiently at low cost; reducing reforestation costs; and securing and developing human resources to support forests and forestry, among others.

In implementing such measures, it is also important, in cooperation with machinery manufactures and research institutes, to develop forestry machineries that enables safer cable harvesting at low cost as well as labor-saving reforestation. Utilizing advanced technologies such as robotics and ICT is also essential.

In this Joint Regional Meeting on Productivity and Safety of Final Cutting on Mountain Forests, experts with extensive knowledge and experience from across the world are



going to discuss how to increase the productivity and enhance the safety of the forestry. Participants are also invited to a field trip to harvesting sites to learn and discuss about Japan's forestry practices. I hope this meeting would benefit not only the participants but also the forestry in Japan making its advancement.

Last but not least, I would like to extend my gratitude to the organizer and all the participants. I sincerely hope this meeting will be fruitful for all of us, and help strengthen international cooperation in the forestry sector.

Thank you for your kind attention.

Director of National Forest, Forestry Agency  
Koji Hongo

## **Greeting Message**

Department of Agriculture, Forestry, and Fisheries, Ehime Prefecture  
Director Mr. Ryuji Tadokoro

I would like to express my congratulations to the IUFRO for the international meeting held in Ehime Prefecture today. Moreover, I would like to express my sincere welcome to the many researchers who have come to Ehime from Japan and various foreign nations.

Here, Ehime Prefecture is blessed with a genial climate, the beautiful scenery of the archipelago in the Seto Inland Sea, which is referred to as the East Asian Aegean Sea, rich natural surroundings, including Mt. Ishizuchi, the tallest mountain in western Japan, the Dougo Onsen, one of the oldest hot springs in Japan, and the historical culture typified by the Shikoku Pilgrimage to 88 temples.

I hope all of you will experience the rich natural and cultural surroundings during your stay in Ehime Prefecture.

Ehime is a leading forestry prefecture, with about 400,000 ha of forest dominating 71% of the prefectural land area. The artificial forests, which our ancestors planted through their endless efforts, are at peak harvest age now.

The volume of timber produced by these rich forests is highly ranked. In particular, the production volume of the Hinoki log is the second highest in Japan.

To pass these valuable forests on to future generations in a healthy condition, Ehime Prefecture makes every effort to maintain and improve the public functions of the forests, for example through watershed protection and sediment discharge protection, while simultaneously encouraging positive usage of forest resources. Thus, we implement various measures aimed at balancing conservation with utilization to realize sustainable forest management.

We also foster forestry as the main local industry to create new domestic and international timber markets.

I would appreciate if all of you would help develop the forests and forestry of Ehime by supplying new knowledge and experiences from different parts of the world.

Finally, I wish continuing prosperity for IUFRO and good health and fortune to all participants.

Thank you very much.

## Opening Remarks

Dear Colleagues,

On behalf of the International Union of Forest Research Organizations (IUFRO), I would like to thank Professor Yozo Yamada and the members of the organizing committee for hosting this Joint Regional Meeting of IUFRO Research Group 3.03 Forest Ergonomics and Research Group 3.06 Forest Operations in Mountainous Conditions. This Joint IUFRO Meeting provides an opportunity to share knowledge across research groups, and collectively identify critical issues in our discipline and how best to address them. It is my great pleasure and honor to be a part of this wonderful event.

As the global forest engineering community, we currently face many challenges in our discipline. Some of the big challenges include global decline of forest engineering research and education capacities, and diminishing visibility of our research and recognition of its importance to the larger forest science and practice communities. Overcoming these challenges requires all of our efforts, our unification, new ways of thinking, and new levels of collaboration among us. This Joint IUFRO Meeting is a great example of our effort to create new ways of thinking and new levels of collaboration through interdisciplinary research.

I want to thank all of the speakers and participants for their contributions to make this Joint Meeting a grand success. Your participation makes large contributions to our effort to expand our research and education capacity, to enhance our visibility, and to bring in new innovations to our profession. Thank you for participating in this Joint IUFRO Meeting, and thank you for being part of our great journey to overcome our challenges.

Best regards,

Prof. Dr. Woodam Chung  
IUFRO Division 3 Coordinator  
Professor of Oregon State University

## **Congratulatory Address**

Prof. Dr. Yuki Imatomi

President of Japan Forest Engineering Society

Professor of Tokyo University of Agriculture

I would like to congratulate this Joint Regional Meeting of IUFRO RG3.03.00 and RG3.06.00 in Asia on behalf of the Japan Forest Engineering Society.

Let me begin by giving you a brief outline of JFES. The Japan Forest Engineering Society was first established in 1951 with the aim of bridging the gap between research and actual forestry, and to promote forest engineering technology. The members encompassed researchers, administrators, forest engineers, forest managers, and forestry machine manufacturers.

The harvesting of timber and the utilization of forests both require expertise regarding ecosystems and the environment. Conflicting objectives such as economics and ecology, productivity and the environment, and harvesting and regeneration must be resolved and harmonized scientifically and technologically. JFES publishes the Journal of the Japan Forest Engineering Society four times a year. Our Journal contains original articles, reviews, research notes, short communications, and miscellaneous news. Our approximately 300 members include individuals, students, organizations, and supporting members.

The range of topics discussed at JFES continues to broaden. It now includes timber production, forest roads, forest machinery, working systems, ergonomics, forest information, and woody biomass. As practical studies for forest and forestry, JFES is identifying challenges to be solved at the worksite, tackling the development of new technologies, and verifying solutions to problems that emerge.

The theme of this Joint Meeting is the productivity and safety of clear-cutting mountain forests. Forest stocks in Japan have increased, and how these forest resources should be used is a growing problem. It is expected that the clear-cutting of mountain forests will increase in the future. This meeting is therefore timely for our country. Timber harvesting in mountain forests must also cause minimal damage to the forest environment. Harvesting systems must also be adopted that are optimized to local working conditions. Productivity and occupational safety are also important factors in timber harvesting. International meetings such as this are of special significance to Japan, which has many mountainous forests. I hope that the purposes of this meeting will be achieved, and that the participants from each country will be able to exchange a wide range of opinions and information.

## **Closing Ceremony: 28th July 2017**



## GREETINGS

It is my great pleasure to be here with you at Joint Regional Meeting of International Union of Forest Research Organization in Asia, Forest Ergonomics and Forest Operations in Mountainous Conditions Units.

I consider it especially meaningful that various presentations, inspections and discussions have been held at this conference and addressed the main theme of **“Productivity and Safety of Final Cutting on Mountain Forests”**.

I am a horticulturist, and my research interest focus on tree fruit production. Tree fruit science has aimed to improve fruit yield and quality mainly with reproductive physiology in woody crops.

Agriculture is a practical learning on the usage of solar energy basically. We have gone toward to find the most efficient methods for converting solar radiation into human welfare through bio resources including plants, animals, and microorganisms, with concerning agricultural technology.

Forestry and tree fruit science would be different in targeted plant parts, however they have a same principal on trapping of solar benefit with woody plants.

Japanese fruit orchards have been mainly conducted on inclined land, sometimes steep, because flat land are used paddy rice field in Japan. So Forest Ergonomics and Forest Operations have given many ideas and practical techniques to tree fruit science, for example, on improving laver efficiency on steep fields. I believe solar energy resource radiated on mountainous area and our conducts on trapping and efficient usage of the solar benefit with woody plants are important for sustainable development of our livelihoods in the future.

Kochi prefecture is mountainous region. We have over 2500 mm annual rainfall, 17 degrees of annual average temperature, and deep forest. You could see our rich forest enough in the inspection tour. I wish this conference would be fruitful, enjoyable, and would stimulate academic curiosity in all participants.

Thank you very much.

Tsuneo Ogata

Dean of Agriculture and Marine Science, Kochi University

## **Congratulatory remarks**

Yoshiharu NOZUYAMA, Director General of Shikoku Regional Forestry Management  
Bureau, Ministry of Agriculture, Forestry and Fisheries

It's my great pleasure to welcome all of you to Shikoku region for the Joint Regional Meeting of IUFRO in Asia. The Shikoku composed of Kochi, Ehime, and Tokushima and Kagawa prefectures is so steep mountainous region where forest areas account for 74 percent of total surface. There are not only abundant forest stock but also growing wood demand for industrial and energy use in this region. The forest operators make log production by using combined forest road and cable system suitable for the each condition.

The first challenge the forest industries in Shikoku are now facing is how to make stable log supply to sawmill and energy industries .The second is how to reduce the cost from the upstream to the downstream of wood supply chain. In this respect, the topic of the meeting “Productivity and Safety of Final Cutting on Mountain Forests” is just timely and good to discuss and find some solution for the challenges we are now facing.

I wish you all a successful meeting and a pleasant stay here in Shikoku.



## **Director's Greeting**

July 28<sup>th</sup> 2017, 11:30~

Location: Kochi Prefectural Forestry Technology Center

I would like to say a few words at the closing of the IUFRO International Conference Joint Asia Regional Meeting.

This month, for five days from the 24<sup>th</sup> to the 28<sup>th</sup>, researchers from all the countries of the world have gathered for this IUFRO International Conference. I am very glad to be able to say that such a grand conference as this comes to a close today without any issues.

Furthermore, I feel that this has been an extremely valuable international conference for Kochi Prefecture and Ehime Prefecture, two prefectures surrounded by many precipitous mountains. For example, the inspections of the raw materials manufacturing sites distinctive to mountainous regions and discussions on improving labor productivity and safety of timber transportation.

Kochi Prefecture, as well as being the number one forestry prefecture in Japan with 84% of prefectural land being forests, is also rich in forest resources such as Japanese cedar and Japanese cypress, and produces Hata Cypress and Yanase Cedar.

Since 2009 we have been working on an industrial development plan to make full use of these abundant forest resources without waste and are aiming to be one of the country's leading producers of domestic timber with the help of young people working in the mountains.

Up to now, we have been maintaining our large-scale manufacturing facilities and ligneous biomass energy, as well as using CLT as a core resource in our efforts to expand the demand for timber. As a result of this, last year, the quantity of raw timber produced was 628,000 cubic meters, a one and a half increase from 2009.

In an effort to further increase the quantity of raw timber produced, we will continue devoting ourselves to the development of easy-to-use tower yarders to deal with furrowed terrain, in addition to the expansion of "forest factory", a consolidated factory block, and the introduction of high-power silviculture equipment.

Furthermore, at the Prefectural School of Forestry, which opened in 2015, we are training the leaders necessary to promote such activities and nurturing people to become immediate assets. On top of this, starting from April next year, three specialized courses aimed at training high-grade, specialized personnel will be introduced: Forest Management, Forestry Technology, and Wooden Design. The school's first principal since being renamed "School of Forestry", is set to be Professor Kuma Kengo, a designer for the 2020 Tokyo Olympics main stadium.

To the people who have gathered here, I hope you will lend us your assistance in working towards a prosperous forestry industry here in Kochi, with new angles and advice regarding the development of management techniques and silviculture equipment to deal with the precipitous and furrowed terrain distinctive of Kochi Prefecture.

In addition, this year is 150 years since the restoration of imperial rule, next year will be 150 since the Meiji Restoration, a turning point of a year. In Kochi Prefecture, which has turned out many great people such as Sakamoto Ryoma, the “Shikoku, Kochi End of Shogunate and Restoration Exposition” is currently being held. The “Kochi Castle Museum of History”, a museum on the east side of Kochi Castle which opened its doors in March this year, is the main exposition location, and is accompanied by 20 other locations across the prefecture. Nothing would please me more than if you were to visit these locations and enjoy Tosa history.

I would like to address the conclusion of this meeting by wishing for the continued development of the IUFRO International Conference, along with the good health and prosperity of everyone gathered here today.

July 28th, 2017

Kochi Prefectural Forestry Promotion/Environment Director  
Tadokoro Minoru

\*CLT - Cross Laminated Timber

## **Closing message for the participants of the meeting**

I would like to express my congratulations to the successful ending of the Joint Regional Meeting of IUFRO RG3.03 and 3.06 in Asia.

During the meeting, I believe that all of you enjoyed the five days of the experience not only on research presentation programs but also visiting the Japanese forestry sites.

How did you feel about the actual forests and the logging practices in Japan?

To date, logging cable systems have definitely decreased in number while logging operations have been increasingly conducted by vehicle-based machines. This is because of continuous development of forest road networks during these 30 years which resulted in growing number of forwarders. However, in Shikoku Island, where the terrain is extremely steep, a considerable number of logging cable systems are still in operation. Among them, the H-type logging cable system is one of the feelings of pride of Kochi Prefecture.

The visit to the logging site of H-type cable system will be a pleasant memory especially for the participants from abroad.

I hope the experience of the meeting will be some help for your research activities and also for improvement of productivity and safety for forestry all over the world.

On the closing, I wish good health and success in the future of every participant.

Forest Research and Management Organization  
Forestry and Forest Products Research Institute  
Shikoku Research Center  
Director-General  
Toshiro HARADA

## Final conclusions

Raffaele Cavalli<sup>1</sup>

<sup>1</sup> Dept. TESAF, University of Padova, Italy – Coordinator IUFRO RG 3.06.00

After the nice speech made by Prof. Woodam Chung, Coordinator of IUFRO Division 3, at the end of the Farewell Party in which he has emphasized the relevance and the uniqueness of the meeting and the fact that it has played the role of communication platform for the young researchers who have taken part to the event, it is difficult for me to say something different.

So I am going to try to share with you the Final Conclusions as a sort of Questions and Answers time.

The first question is: has the Meeting achieved the goals of IUFRO standards?

The answer is: yes, it has. In fact 68 participants took part to the meeting: 14 foreigners, 40 Japanese, and 14 VIPs (Authorities and Sponsors). There were 12 oral and 24 poster presentations, some of them carried out by young researchers and students.

The second question is: did the meeting fulfill the ambition to be a regional meeting in Asia?

The answer is: yes, it was. Participants coming from Universities and Research Centers of Japan, Indonesia, Thailand, Malaysia have attended the meeting; furthermore University researchers from Czech Republic, Italy and Turkey have enriched the participation to the meeting.

The third question is: was the meeting a true joint meeting of IUFRO RG 3.03.00 and RG 3.06.00 ?

The answer is: yes, it was: 31 contributions related to forest logging operations, mostly referring to mountain conditions, plus 6 contributions related to ergonomics have been delivered in the different sessions.

The fourth question is: has the meeting achieved the aims set up by the Organizing

Committee?

The answer is: yes it has. The aims were basically the following:

- To exchange mutually recent research achievements and information
- To discuss mountain logging operation techniques and ergonomics
- To evaluate the possibility to improve both working productivity and safety of final cutting on mountainous forests

The regional level of the meeting has allowed bringing in the foreground contributions that in a different context would have risked to be less noticed or unnoticed at all, providing a more homogenous context in which the mutual exchange of the research achievements and information has been facilitated and more effective.

Discussion and evaluation have not been limited to the indoor activities (oral presentations and poster presentations) but they continued throughout the well-organized outdoor activities during which participants have had the chance to keep in touch with different logging systems, forest road construction techniques, forest management rules adopted in mountainous forests of Shikoku Island.

In general the quality of the contributions was good; both the oral presentations and the posters have been clearly delivered and supported by steady research activity.

A special satisfaction comes from the fact that the meeting has been used as a sort of training ground for young researchers, some of them presenting their paper in English for the first time.

As Coordinator of IUFRO RG 3.06.00 and senior scientist my concluding thoughts go to these young researchers; to them I recommend to

- never forget that scientific research must be characterized by passion and ethics
- be faithful to your scientific area of interest but do not fear to be “contaminated” by other scientific fields.



## **I. KEYNOTE SPEECHES**





## O-01

### North American Trajectories of Development in Final Harvests

Dr. John J. Garland, PE<sup>1</sup>

<sup>1</sup> Consulting Forest Engineer, Garland & Associates  
Professor Emeritus, Forest Engineering Resources and Management, Oregon State  
University  
Affiliate Professor, Pacific Northwest Agricultural Safety and Health Center, U.  
Washington  
PO Box 152, Waldport, OR 97394-0152  
Cell Tel: 541-231-6241 Landline: 541-563-3555  
E-mail: [johngarland49@gmail.com](mailto:johngarland49@gmail.com)

#### 1. INTRODUCTION

In order to chronicle the development of final harvesting in North America (primarily the United States and Canada) one must be selective about coverage. The time period to cover is established as three periods: Prior to 1900; 1900-1950; and 1950 to the present. As these periods are my own selection, I have most knowledge from 1950 to the present as it coincides with my own life span and fifty-year career in forest harvesting.

The forest regions to cover are also my choices. I recognize these regions as somewhat distinct:

- The Northeast of the US and maritime provinces of Canada
- The middle hardwood region of the US and Canada
- The intermountain West of the continent
- The boreal forest of Canada and Alaska
- The southern pine region of the US
- The Pacific forests of the US and Canada

There are no clear lines among these regions and they may overlap in coverage with ecosystem pockets within each. However, the commonality of tree species, geography, foundational ecosystem forces (fire, insects, etc.) make the regions distinct. The pattern of final harvesting makes these regions useful for my treatment. My university career was spent mostly in the West but I have had consultancies or travels in all these regions.

The many threads of development in forest harvesting sometimes coalesce into a

pattern or trajectory of development that can bring useful insights. For this treatise I will discuss the following trajectories.

- The Workforce including worker safety and health
- Trends in Technologies for felling, skidding/yarding/flying, and transport
- Trends in Productivity and the nature of final harvests

For some components of these trajectories there are data sets or computations that provide insights. For others, I provide my own best estimates or insights. Along the way I wish to share some personal contributions to forest harvesting as a sideline.

## **2. THE WORKFORCE**

### **2.1 Fatalities**

Over a period of more than 117 years, the workforce would be expected to change. Forestry work is seen as dangerous, difficult, dirty and declining. Logging is typically the most dangerous job in the US and has been rated as the “worst job” in America. Prior to 1900 we have little information on worker deaths; from 1900-1950 high fatalities are associated with a large workforce and dangerous work; since 1950 major efforts have reduced fatalities in all regions. However, the trajectory of fatalities in developed countries is exponentially downward over time as shown by Washington state statistics in Figure 1. From a high of 224 killed in the 1920’s to single digits currently, often below five fatalities. Oregon has a similar trajectory and had years with no fatalities. Other regions in North America have similar statistics but there are differences in reporting all forestry related deaths. Other developed forestry countries (e.g. Scandinavia, Central Europe, New Zealand, Chile, Japan, and others) have made strong progress at reducing fatalities while developing countries have serious safety problems.

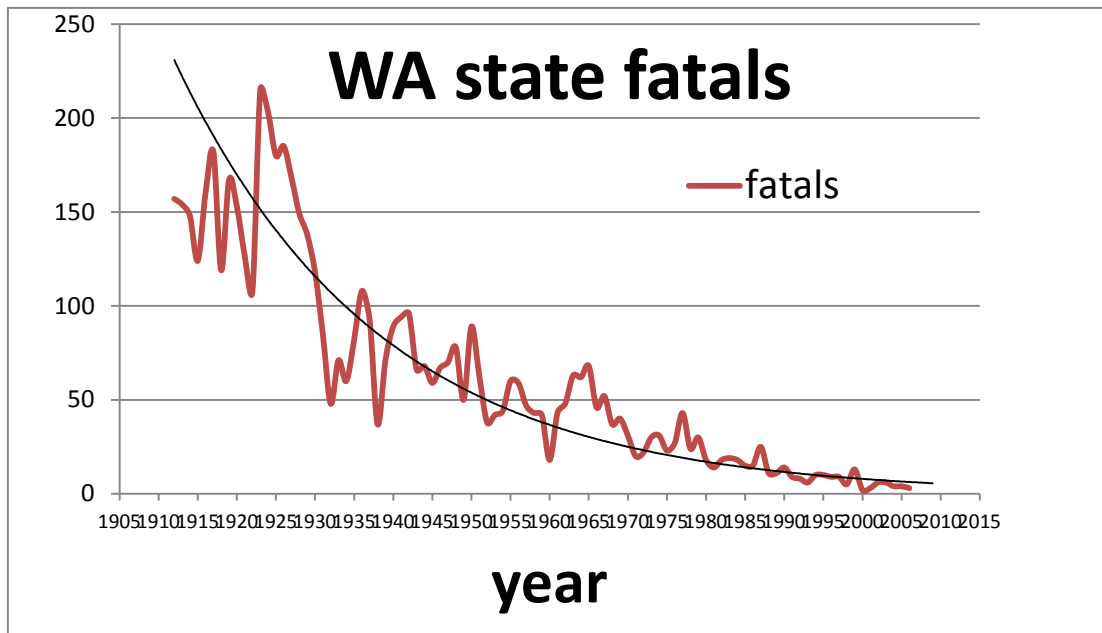

Figure 1. Washington state has made progress over time in fatality reduction (WA Labor & Industries data)

## 2.2 Age & gender

Men and women work in the forest; men more than women. In Oregon less than 3% in commercial forests are women, mostly truck drivers and some machine operators. Only recently has the mechanization allowed women into machine cabs to work in all regions. The increasing mechanization should make more opportunities for women in forest harvesting. Better machine design will help in the maintenance activities as well.

Prior to 1900, the population was not living to older ages; thus, those working in the woods were younger with an estimated median age of <30. The work was also arduous more suitable to younger workers. From 1900-1950, young men often worked in logging camps doing difficult and dangerous work. I estimate the median age around 40 years. Since 1950 the logging workforce is aging and in Oregon I estimate it to be around 50 years. I did one study where the median age of log truck drivers in Idaho was greater than 60 years. Machine operators are able to work later in life than those cutting trees with chainsaws or working on cable logging operations. Figures 2. and 3. show the US workforce aging and having more accidents as they age (Oregon data from Department of Business and Consumer Affairs).

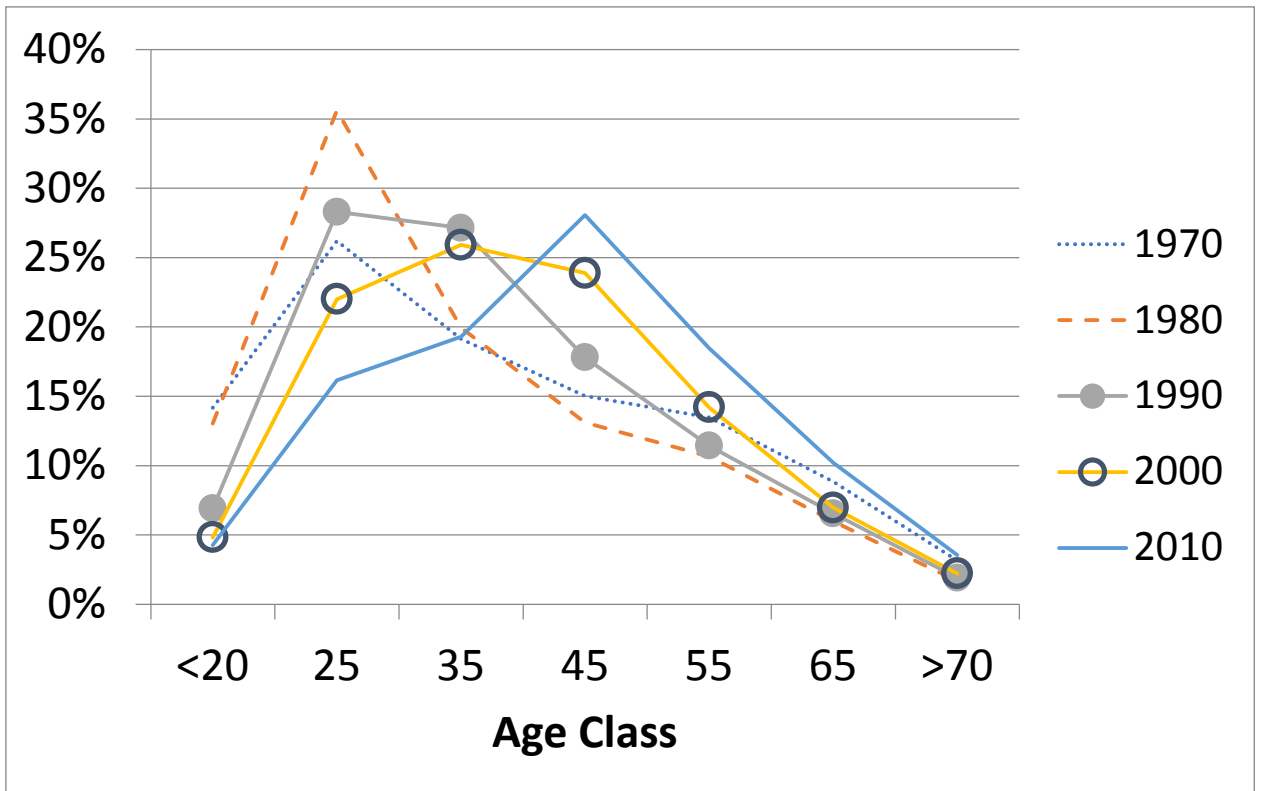

Figure 2. The US logging workforce and shifts in aging

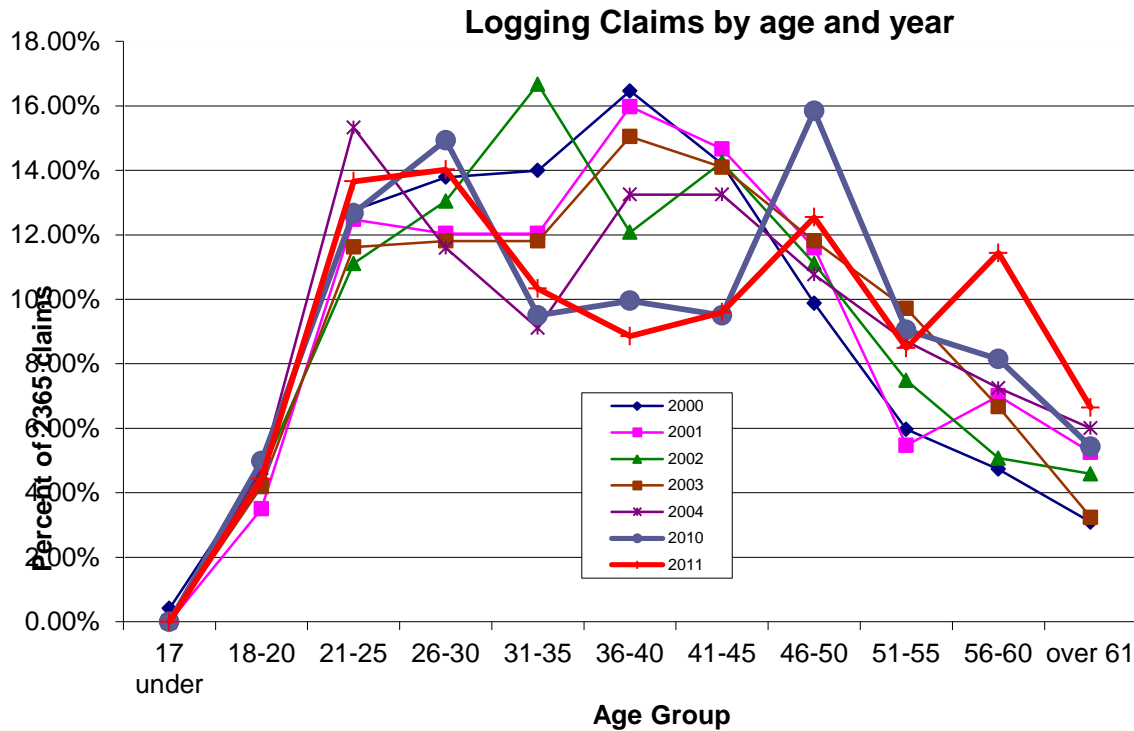

Figure 3. Increases in Oregon accidents by age group. Half of the fatalities were workers over 45 years.

### **2.3 Firm size and workforce availability**

I have followed the average firm size in Oregon over my career and seen it decline to about 6 employees per firm at present. The largest firms were in the period 1900-1950 where logging camps of 200 workers were common. In 1950 as the camps phased out, firms were still had 40-50 workers but continued declining over the next years. While there are a few logging firms in Oregon over 100 employees, they often combine forestry services, logging and trucking in their business model. The reduction happened in part from large companies replacing their company logging operations with contractors in the 1980's recession across North America. Canadian firms are larger than those in the US but are largely contractor employees. In the past union workers were a majority of loggers but now are likely less than 5% in the US. In some states in the South, firm size is limited by a size that avoids requiring Workers Compensation Insurance (e.g. 10 employees) and oversight by Occupational Safety and Health Inspectors. Single proprietors and partnerships also may not be covered by Workers Compensation Insurance or workplace inspections. Log truck drivers, timber fallers, and specialized machine owners often fall into this category across all regions.

Across all regions, the forestry sector has difficulty recruiting new workers for jobs that are dangerous, dirty, difficult and declining. Logging contractors may have logging equipment they cannot utilize because they don't have the workers. One large trucking owner has 130 trucks and 95 truck drivers available. Workforce availability pushes firms to mechanization but training programs for forestry workers are generally non-existent in the US. Wages in logging during the middle 1900's was generally above the typical prevailing wages. Recessions and declining timber supply brought forestry wages comparable to wages in cities and towns. Figure 4. shows relative wages for logging declining over the recent past Rural Canadian forestry areas are better positioned to maintain a workforce but they still have difficulties at present.

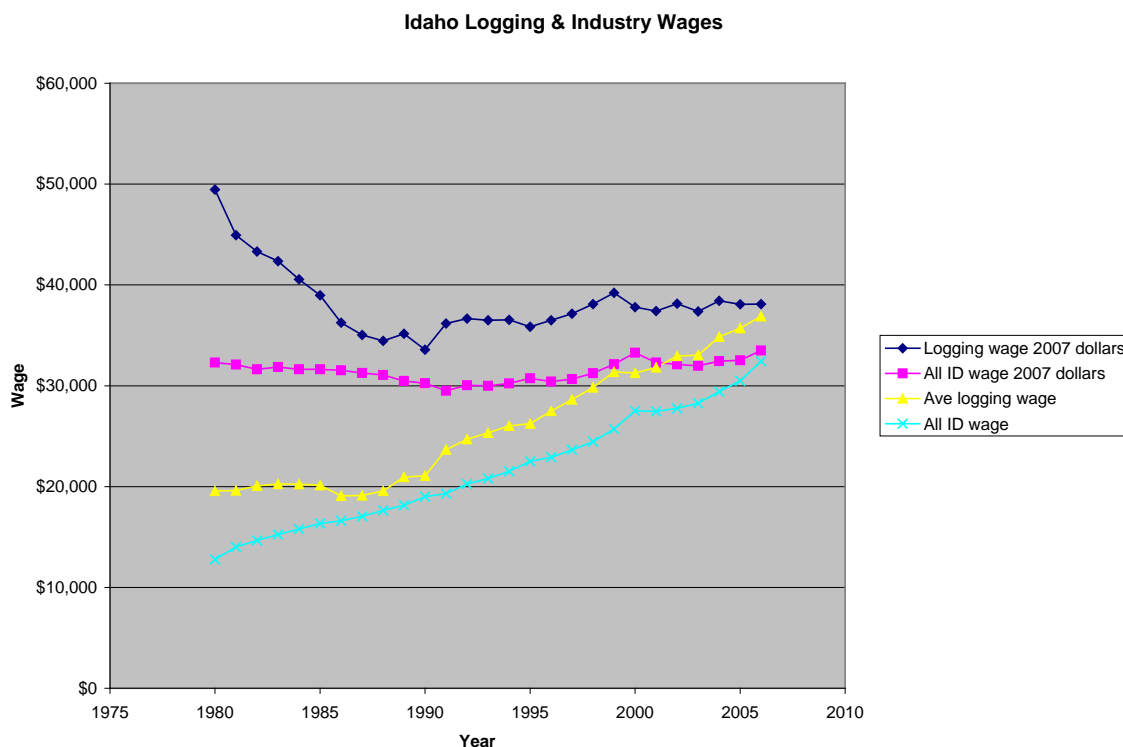

Figure 4. Idaho logging wages falling to levels of all industries (Garland, 2011).

## 2.4 Health

In forestry, work related health issues are not as recognized as in other industries. Pesticides and chemicals are covered as are poisonous plants and animals. Heat related illnesses are recognized as well. Prior to 1900, other illnesses unrelated to work took their toll on the population. The heavy workloads in forestry from 1900-1950 kept the workers generally fit. They consumed 6000-8000 calories and were mainly subject to musculoskeletal damage over time. From 1950 to today as mechanization continues, operators are facing health risks from their work sitting in cabs for long shifts. Truck drivers face similar risks. Risks for diabetes, obesity related diseases, heart disease, sleep apnea, back pain, nerve damage, arm and shoulder damage, and sedentary-related diseases are all increasing for workers. Canada may have better assessment of worker health risks but the US has 50 states with differing views of work related health problems across the forestry regions. Working in an air-conditioned, stereo equipped, cabin for 10 hours or driving a truck is a threat to worker health and workforce viability.

## 2.5 Personal

My personal commitment to forestry workers is evident in my publications,

presentations, research efforts and public service. For nearly 35 years, I have served on the Advisory Committee for the Division 7, Forestry Activities safety code. As an engineer, I have helped shape the Oregon safety code in forestry using current research and engineering practices. The Advisory Committee is composed of loggers, foresters, landowners, government agency professionals and Oregon Occupational Safety and Health inspectors with over 450 years of experience (my estimate). The Forest Activities Code has evolved through three major revisions from a rule-based code prescribing tools, equipment and work practices with definite and specific code language that must be followed to achieve for safety and health management including required training and supervision practices to prevent forestry accidents. There are still specific requirements in Oregon's code but the Advisory Committee and OROSHA (Oregon Occupational Safety and Health Administration) recognizes more is needed. The Advisory Committee over my tenure has developed safety codes to reflect new technologies and safety concerns (e.g. new tethered steep slope logging). Adjacent states often adopt Oregon's rules in their safety codes.

### **3. TRENDS IN TECHNOLOGY**

#### **3.1 Felling**

Prior to 1900 the axe was the primary felling tool. Axes of different shape were also used to make "square" timbers for building and for ships. Early in the 1900's the combination of axes and saws combined to make it possible to fell large trees up to more than 4 meters in diameter. The long saws had teeth designed to widen the kerf (cut) and remove sawdust with the stroke. In regions with smaller timber, bow saws made effective cutting tools. By mid-century chainsaws were in common use. Large saws took two men to handle them but they made cutting much faster than hand sawing. From 1950-1970's large powerful chainsaws were in use. They were heavy, loud, and produced dangerous fumes and vibration that damaged workers. From the 1970's to present, chainsaws got smaller, faster, and more ergonomic making them the tools of choice for big and small timber. I now own a battery powered chainsaw with Japanese design roots.

The direction of fall for cutting trees is mostly a matter of using the cuts at the base of the tree to control lean, limb loading, wind, etc. so the tree falls as intended. I am unclear where wedges for felling came from but they are useful. For example, an 80 meter tall Douglas-fir 125 cm in diameter can be moved 150 cm at its top with a 2.5 cm lift in the back cut. Such large trees were so valuable in the Pacific western forests that efforts were made to keep them from breaking apart when felled downhill on steep slopes. One company climbed the tree and used a winch at the landing to pull the trees

uphill to save them. I was working with Weyerhaeuser early in my career and we developed the known technology of using hydraulic jacks called the “Dellwood Timber Tipper.” It worked but was too heavy at 50 kg and another innovator developed an effective pump and jack system that was much lighter. When I went to Oregon State I demonstrated this system throughout Oregon, Washington and British Columbia. Within two years, 1500 sets of this technology were sold in the Pacific west. Many large trees and problem trees were felled with hydraulic rams. I made a movie of the technology.

Crosscutting (called bucking) trees into merchantable logs evolved from handsaws to effective chainsaws to mechanized processors. There are great value difference when the bucked logs meet their optimal value for a processing plant. An Oregon State team developed programs for computers (hand-held and office) that documented bucking for value could gain 5-20% if used in valuable timber. We were ahead of our time and hand fallers did not adopt the approach but the work served as the basis for technology embedded in modern harvesting machines.

Mechanization of felling began in Canadian provinces with small trees and spread to the US Northeast and South. Scandinavian concepts and machines were adapted to North American conditions. Trials were made with cutting devices similar to agricultural combines, cutting screw heads, rotating fixed saws, shears, circular saws, Prior to 1900 we have little information on worker deaths; from 1900-1950 high fatalities are associated with a large workforce and dangerous work; since 1950 major efforts have reduced fatalities in all regions. For a time, felling machines using shears were most popular in the small timber in North America. Currently, large circular saws using the inertia of a large disc and bar saws are most commonly used. While extremely efficient at cutting trees, these saws are not without hazards. I had many legal cases where circular saws threw objects like wood or saw teeth that injured or killed adjacent workers. A simple extension of guarding removed the hazard. Bar saws can have the chain break and throw pieces of it as “chain shot” that have killed or injured as well. Research showed that current guarding and operator protection were inadequate.

### **3.2 Skidding/Yarding/Flying**

It is amazing how loggers move logs. In the Pacific west, gravity was used to roll logs downhill aided by hand jacks (like large auto jacks) to keep the logs rolling. Horses, mules, and oxen were used in all North American regions to drag or pull logs. Logging became legendary as Paul Bunyan and Babe, his blue ox, logged the Minnesota pine trees. Babe’s hoof prints all across the state were said to have formed the more



than 10,000 lakes rather than ice age glaciers. Nostalgic horse logging is still carried out across North America minus the colorful curses early loggers shouted.

From 1900 to 1950 machines evolved on tracks and wheels to become crawler tractors and efficient skidders and forwarders. Major manufacturers and local innovators helped develop better and better engines, drive trains, loaders, tires and tracks. During this same period where cable logging was needed, steam winches were replaced with combustion engines and wooden spar trees were replaced with metal towers (One of my first jobs in the middle 1960's was to mark potential spar trees—the last time they were used). Yarding was separated from the railroad lines and uphill yarding to truck roads became the common practice. Yarders were large and powerful and many different carriages were used as well as “high lead” logging using just two lines to move logs and rigging with the logs dragged on the ground. As seen earlier, this period was the most hazardous for rigging crews as fatalities showed.

From 1950 to the present yarders became both larger and smaller to meet regional needs. Large grapple yarders reduced hazards and could be productive. In 1976 I worked with a company to use black and white TV cameras to aid grapple logging. The idea worked but the camera technology was not sufficiently robust. Forty years later, cameras on the grapple project color images on a large screen in the cab showing precisely where the grapple and logs are located on terrain. Smaller yarders from Europe and homebuilt ones were used in thinnings and in small wood in mountainous regions of North America. In the late 1970's a colleague and I demonstrated a small European yarder across Oregon and finished the last one as Mt. St. Helens erupted. I also worked with synthetic rope to replace the heavy steel lines in cable logging. That rope research has led to drones rigging small synthetic lines so larger steel lines can be used in setting up the yarder across long distances and steep slopes. The lack of new yarder development, hazardous working conditions and the lack of a yarding workforce are combining to reduce logging with yarders.

### **3.3 Shovel logging and tethered machines**

In 1980 a Washington state logger used a hydraulic excavator loader (shovel logging or hoe-chucking in BC) on a wet site unsuitable for skidding to swing trees in successive moves to the landing. One operator and a landing processor produced 750 cubic meters in day and the shovel operator loaded trucks as well. This became shovel logging and spread across the Pacific west quickly. Used mostly in clear cuts on slopes up to 50% or so, shovel logging became the cheapest system when it could be used. Improved shovel logging machines and operating techniques keep it productive. Areas that were formerly cable logged are now routinely shovel logged. Safety hazards are greatly

reduced and incentives in Workers Compensation Insurance further favor shovel logging. Mechanized felling combined with shovel logging is common across the Pacific western forests.

Steep slopes in the west present a challenge to mechanization. Technology coming from New Zealand uses tethered machines in felling and shovel logging to harvest areas previously hand-felled and yarded. Adaptations are coming quickly in the west as tethered felling machines capable of shovel logging on steep slopes with a one person operation. Manual work exposes perhaps 15 workers to hazards rather than one operator in a protective cabin. A system using a tethered grapple skidder has also been used on steep slopes.

Research at Oregon State is examining the safety and stability of the system. I am studying the operators for the effects of working on 60-90% slopes for long shifts. Heart rates, electrodermal measures, temperatures, vibration along with eye-tracking studies are providing interesting observations. Stability studies are helping distinguish between traction assistance versus machine support. Both tracked machines and harvesters/forwarders are using tethered technologies. More research is needed especially when tethered felling is combined with grapple logging.

### **3.4 Balloon and helicopter yarding**

For a period from 1960 to 1990, balloon and helicopter yarding were developed and used in the Pacific western forests. Helicopter logging was used in other North American regions as well. Balloon logging was developed to extend cable yarding by providing the aerial deflection to make skyline yarding effective. Efforts to use dynamic lift by moving the balloon carrying the logs were unsuccessful. A large static balloon provided lift so logs could be yarded by a specialized yarder. Later efforts to use inflated aerial vehicles (Cyclocrane and Heli-stat funded by the military) were spectacular failures. These were never seen as viable by the forest industry.

Helicopters are still used in British Columbia to harvest high value trees using a “standing stem harvest.” Valuable trees are cut nearly through and a specialty helicopter grapple attaches to the tree, breaks the final cut and lifts the tree away. Aerial systems depend on large, high value trees for harvest. Private lands use other systems and public lands across North America make few harvests available.

### **3.5 Transportation**

Water transport of logs was an original method in North America. Trees were felled directly into rivers, bays and streams to be carried to mills. Splash dams and river drives were common in 1900-1950 across North America. Log rafts were towed to

mills in large volumes. I worked in Coos Bay, Oregon where two logging camps each delivered 5,000 cubic meters daily to the large sawmill. Coos Bay was the world's largest lumber shipping port for nearly 30 years. Much of the product was loaded on Japanese ships ("ship's name" Maru) for shipment. Prior to 1900, finished products from Coos Bay were shipped to San Francisco and Chilean ports. Today logs are shipped to Asia and other ports from Coos Bay. Logs are still rafted in British Columbia and Alaska but most are now barged to destinations. Eastern Canada and the South send finished products to Europe by barge and ship.

Prior to 1900 through 1950 railroads were important for transportation. Early on, railroads were extended into the forest and connected with active logging operations which loaded directly and transported logs to mills in North America. Later rail terminals (woodyards) had logs brought from the forest with animals or trucks for travel to distant mills. Some logging railroads transport logs to mills but trucks are the dominant transport system.

Logging trucks came to the woods in early 1920's with solid tires and roads made out of wooden planks. Sometimes only one log was on the truck but trucks were faster and more mobile than fixed railways. Some trucks added loaders and loaded their own logs. Improvements came fast and roads were built in the forest for truck transport. Many variations on trucking occur across North America. Large heavy loads are allowed on Canadian highways while American states control the weight limits for their roads. US federal highways are governed by a federal agency that not only prescribes truck weights, load securement requirements, safety measures but also driver hours of service and medical evaluations. In some states logs are exempted as agricultural products but not in others. While there are some larger truck fleet operations, most logging trucks are single owner/operators. Some areas dispatch the single trucks as part of an efficiency effort to utilize transportation resources. Environmental regulations on truck engines and added costs hinder new truck purchases. Log truck drivers may throw wrappers over the load with similar shoulder and arm damage seen in professional baseball pitchers. I tested synthetic rope wrappers that reduce the wrapper weight by 60% and a commercial firm produces them in the west. While they are more expensive, drivers who might have quit their work are still able to do their job.

#### **4. TRENDS IN PRODUCTIVITY AND THE NATURE OF FINAL HARVESTS**

##### **4.1 Productivity**

Forestry professionals are interested in productivity of harvesting. I can identify the key factors of harvest productivity but emphasize that people make the difference. Well-trained, safe and productive workers can make differing operations productive.

The factors for productivity are:

- Tree size as indicated by their diameter
- Volume per area harvested
- Terrain conditions of slope, traction, obstacles, environmental demands & irregularities
- Planning that helps efficiency
- Operational management that removes limits on the operation
- The system used for harvest

The tree size as indicated by its diameter is important as harvesting is a piece by piece operation. For each region in North America there are likely estimates of the change in diameter over time but I am unaware of data sets for large areas for diameters harvested. I use a typical diameter estimate for harvest in Oregon and a range of diameters during the period. Table 1. shows my estimates. The diameters are influenced by products produced especially in recent times where small trees are harvested for biomass products. In smaller timber, tree length harvesting is common with saw logs produced down to 10cm small end log diameter. Lengths of logs range from 240 to 1200 cm or longer depending on truck length limits.

Table 1. Typical diameters of trees harvested in Oregon by period

TYPICAL DIAMETERS OF TREES HARVESTED		
PERIOD	TYPICAL DIAMETER CM	RANGE OF DIAMETERS CM
<1900	120	50-150
1900-1950	100	50-180
1950 to PRESENT	60	10-125

The volume per area harvested plays a large role in harvest productivity. Large fixed set up costs for logging must be pro-rated over volume harvested. Certainly, this is also a function of harvest system as cable operations have higher fixed costs than ground-based systems. For example, a large cable system may need 450 Cubic Meters per hectare for more than 10 hectares compared to 150 Cubic Meters per hectare spread over 25 hectares for a harvester and forwarder.

Terrain conditions influence productivity. Cable systems need operable terrain and anchors to work properly. Ground-based systems rely on soil and moisture

conditions for traction. For all systems, environmental demands for leave areas, no-entry areas, weather or seasonal constraints influence productivity and thus costs.

Expensive and complex harvesting systems need effective planning to be productive. Analysis programs for cable logging identify problems in advance of moving the machines to the logging site. They can identify difficult cableways and anchor possibilities to avoid the safety hazards of failure (skyline or tower tipover). My legal experience in deaths, injuries, and failures confirms the value of planning and analysis. Similar programs can help ground-based systems.

Productive operations require operational management that removes limits on the operation. Poor maintenance or lack of critical parts render productive machines useless. I made a video of “Tackling Productivity in Mechanized Logging” to show how operators can recognize the operational 5B’s: Balance, Breakdowns, Bottlenecks, Buffers and Blunders. Failure of management to make willing operators productive can demoralize crews.

Differences in system productivity can be significant as Table 2. shows for a typical daily production and a range of production for some systems operating in western Oregon. These are my estimates from my consulting work and work at Oregon State University over my career.

Table 2. Typical production and a range of production for logging systems in Oregon

PRODUCTIVITY OF LOGGING SYSTEMS		
LOGGING SYSTEM	TYPICAL METERS PER DAY	CUBIC RANGE OF PRODUCTIVITY
MANUAL FELLING	150	100-800
MECHANICAL FELLING	500	400-800
HORSE SKIDDING	12	8-50
TRACKED SKIDDING	100	75-200
WHEELED SKIDDING	150	75-250
SMALL YARDER	150	100-375
LARGE YARDER	300	200-700
GRAPPLE YARDER	300	200-700
SHOVEL LOGGING	250	175-350
TETHERED FELLING	400	300-500
TETHERED SHOVEL LOGGING	200	150-350

An interesting trajectory of productivity can be found by taking the statewide harvest volume and dividing it by the estimated days for the logging workforce. Although the actual numerical results in themselves are not meaningful, the trend line is of interest. Figure 5. shows my estimate for Oregon up to the year 2000 (Garland, 1999). The period 1950-1980 shows the highest level for a number of years. Loggers during that time used to set their own goal as “A load per person per day.” Amazingly, the 25 cubic meters per day is the same volume carried on a typical log truck. The drop in productivity coincides with a reduction in harvest levels from federal lands and a drop in log diameters from around 90 cm to around 50 cm. Much of the big equipment in use was not suitable for smaller timber. I have not made the computations for intervening years, but I found that in the year 2015, the comparable number was 23.44

cubic meters per day for the workforce that year. New technologies and adaptations have brought productivity back. Even though the typical log diameter has fallen to near 40 cm.

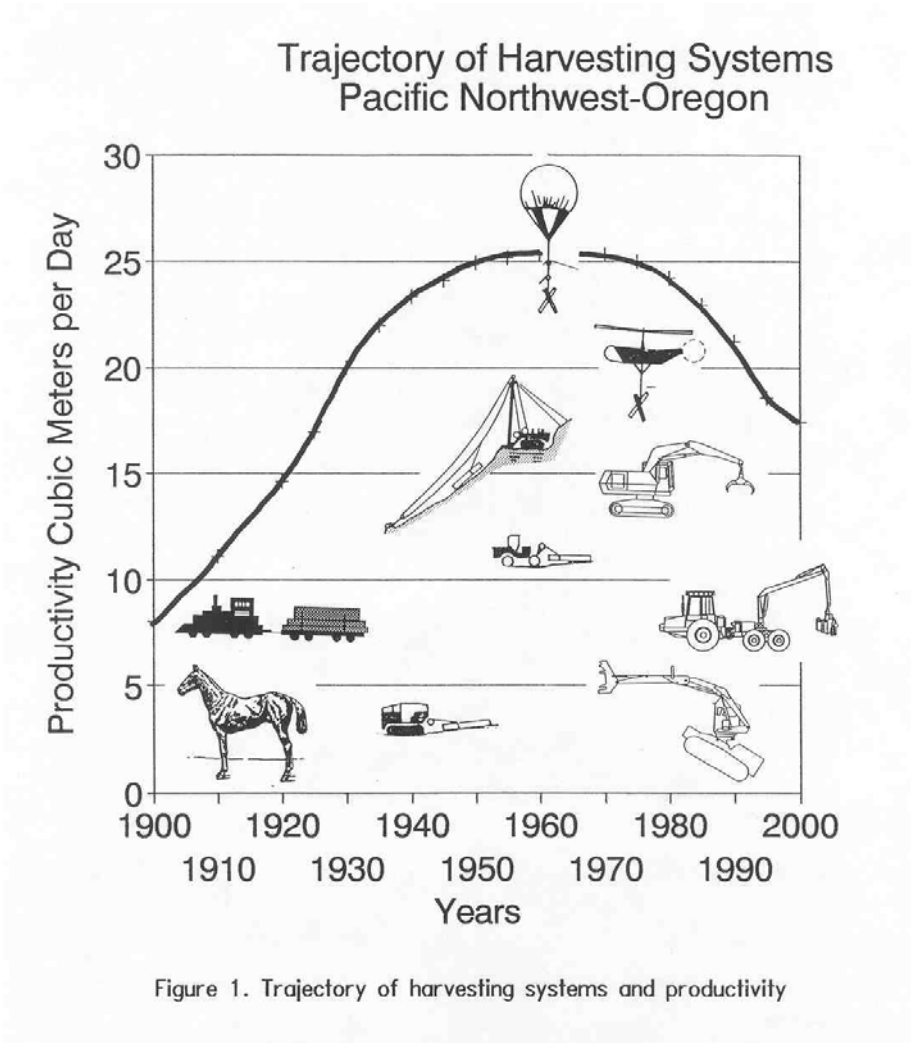

Figure 1. Trajectory of harvesting systems and productivity

Figure 5. Trajectory of harvest systems and productivity (after Garland, 1999)

#### 4.2 Nature of final harvests

The trajectory of final harvests has changed over the three periods across some dimensions. Table 3. summarizes the changes. For the period <1900, the Nature of the harvest was mostly subsistence based, for local use and usually small in scale. For the period 1900-1950, development of forest resources and their use was emphasized. Wood products were the focus and many new products were developed. The scale was more regional in nature—growing as firms expanded. From 1950 to present, large scale operations were common on public and private lands. Both wood products and resources are the focus. The scale of operations is fully National and International.

The forestry objective by period can be identified by actions. Prior to 1900, the main objective for owners was the use of wood. Notable exceptions for spectacular parks and landscapes were made. During 1900-1950, wood products were the focus and efforts were made to keep the land productive while developing roads and infrastructure. From 1950 to present, there is a shift from “forest farming” to sustainable uses to emphasizing resource protections while producing some wood products. Final harvest terminology is replaced with “regeneration harvests” or “vegetation management” and clear cuts are avoided even as they exist in practice, especially for insect/disease and fire salvage harvests.

The ownership of forests has changed over time in form and scale. There have always been an ownership group of small private forest owners across all periods. Their goals shift through generations and public sentiment for forests. In the period 1900-1950 public ownership increased to form National Forests, Tribal forests, and tax returned lands to state and federal governments. Large private owners aggregated lands and formed a vertically integrated industry owning the land, timber, mills and distribution systems. From 1950 to present, there has been a shift where public ownership emphasized wood use and development to stopping public harvesting with lawsuits over endangered species. The industrial ownerships made a shift from corporations with land and mills to forests owned by shareholders, often large investors using the forest as secure investments. Industrial landowner goals have changed substantially during the period.

The specific kind of final harvest has changed as well. Prior to 1900 individual trees were cut to use. Selection cutting would target trees of special interest while small clear cuts were also used. From 1900-1950 selection cutting was extensively employed and led to “high grading” claims. Large clear cuts were efficient but also included “cut and run” operators who left the land to the government rather than reforest it. The end of the period followed WWII and the demand for housing increased harvesting. From 1950 to present harvesting involved selection harvests, improvement cuts (thinning and sanitation cuts), to later period harvests that emphasized restoration to a stated condition. Small clear cuts are allowed under increasing regulatory guidance.



Table 3. The changes of final harvest over periods

TRAJECTORIES OF DEVELOPMENT		FORESTRY OBJECTIVE, RESOURCE OWNERSHIP			FINAL HARVEST	
PERIOD	DIMENSIONS	NATURE	GOALS	TYPE		
<1900	SUBSISTENCE, LOCAL, SMALL SCALE		RESOURCE USE OF WOOD	SMALL OWNERS	SMALL PRIVATE	SINGLE TREE, SELECTION, CLEAR CUTS
			WOOD PRODUCTS, KEEP PRODUCTIVE, DEVELOP RESOURCES	WOOD PRODUCTS, KEEP PRODUCTIVE, DEVELOP RESOURCES	SMALL PRIVATE, PUBLIC OWNERSHIP, VERTICAL INDUSTRY	SELECTION CUTTING, LARGE CLEARCUTS,
1900-1950	DEVELOPMENT, USE, PRODUCTS, REGIONAL		SHIFT FROM FOREST FARMING TO SUSTAINABLE USE TO RESOURCE PROTECTIONS	SMALL PRIVATE, PUBLIC OWNERSHIP, SHIFT TO SHAREHOLDERS		SELECTION, IMPROVEMENT CUTS, RESTORATION HARVESTS, SMALL CLEAR CUTS
1950 to PRESENT	LARGE SCALE, PRODUCTS & RESOURCES, INTERNATIONAL					

## 5. A PERSONAL TRAJECTORY

The forestry sector, firms and indeed, individuals are all on a trajectory of development. My own trajectory has been a rich and fulfilling one working in industry, at the university and now consulting with forest harvesting. I hope to make contributions along my future trajectory with activities on:

- Current research on steep slope logging
- Forest Activities Code Committee
- Accident Investigation and Analysis consulting
- Fulbright Fellowship to Chile to document the trajectory of safety improvement from my work there

- Cooperation with the International Union of Forestry Research Organizations, the Council on Forest Engineering and the UN FAO Forestry Unit
- Travel and adventures with family and friends

Forestry is a subculture across the World. We have much in common and forestry is filled with good people. I look forward to working with them along my trajectory and wish you well on your own trajectory.

## REFERENCES

- Garland, J. 2015. Accident Reporting and Analysis in Forestry. Food and Agriculture Organization of the United Nations, Viale delle terme di Caracalla, 00153 Rome, Italy. 57p.
- Garland, J. 2014. The Limiting Factor in North American Forest Operations: A Skilled Workforce. Annual Meeting, Council on Forest Engineering, Moline, IL, June 23-26, 2014. 6p.
- Garland, J. 2013. A Look at Logger Education after Thirty-five Years. IUFRO 3.06.00 Conference: Forest Operations in mountainous conditions. Norway. June 3-5, Honne, Norway. 9p.
- Garland, J. 2011. Understanding the Idaho Timber Workforce. Paper 11-06. 2011 National Symposium on Agriculture, Forestry and Fishing Safety and Health. International Society for Agriculture Safety and Health & National Institute for Occupational Safety and Health. Boise, ID. June 26-30, 2011. 14p.
- Garland, J.J. 1999. Trajectories of development for individuals, firms, and the forestry sector in a country. In Forest Operations of the Future Joint, FAO/ECE/ILO Committee Seminar held in Bordeaux, France, September 20-24, 1999. Afocel, Soud- Ouest, p. 329-338.
- Garland, J. 1997. Following a trajectory of development for individuals, firms, and the forestry sector of Chile. Terceras Jornadas Internacionales El Trabajo en el Sector Forestal. Asociación Chilena de Seguridad. Concepción, Chile. 10p.
- Garland, J.J. 1990. Assessing Gains from Woodworker Training: A Methodology. Int. Jour. Industrial Ergonomics. (5) 1990. P. 227-242.

## O-02

### **Steep Terrain Forest Operations – Challenges, Technology Development, Current Implementation, and Future Opportunities**

Raffaele Cavalli<sup>1</sup> and Dzhamal Amishev<sup>2, \*</sup>

<sup>1</sup> Dept. TESAF, University of Padova, Italy

<sup>2</sup> Forest Operations, FPInnovations, Canada

\* Corresponding author: Tel: +1 602-222-5633

E-mail: [dzhamal.amishev@fpinnovations.ca](mailto:dzhamal.amishev@fpinnovations.ca)

**Abstract:** There is a huge interest and recent worldwide effort to improve traction of harvesting machines when operating on steep slopes. One way to improve traction and stability on steep slopes is through assisting harvesting machines by winch and cable to anchor locations such as tree stumps or stationary equipment. With the exponential development of technology, an integrated approach must be developed for conducting productive and injury-free mechanical harvesting operations on steep slopes that draws on the skills and accountabilities of the working team. Beyond a certain physical threshold, the only feasible and achievable solution providing some “intelligent behaviour” to machines and systems would be the role of mechatronics application. One of the most relevant points could be the possibility to combine teleoperation with winch-assist technology that would provide a platform for extending the range of ground-based equipment to previously infeasible terrain conditions.

**Keywords:** Steep slope, Harvesting system, Winch-assist, Remote control, Teleoperation

#### **1. INTRODUCTION**

Mountain forests cover over 9 million square kilometres of the Earth’s surface and represent a remarkable 23 per cent of the Earth’s forest cover. They play a key role in mountain areas, offering goods and services essential to the livelihood of both highland and lowland communities. Mountain forests provide a range of ecosystem services that may be divided into three main categories: provisioning services (e.g., timber and fuel wood extraction); regulating and supporting services (e.g., carbon sequestration, hydrological cycles maintenance, soil stabilization); and cultural services (e.g., recreational opportunities, the role of forests in local belief systems and customs) (Price

et al., 2011). In such a perspective it is strategic to develop and maintain forest management systems that provide a balance between land use and conservation of all the ecosystems services offered by the mountain forests.

## 2. MECHANIZATION OF FOREST OPERATIONS

One important tool through which forest management systems can be applied are forest operations that develop sound engineering practices for different terrain and stand characteristics; such practices must be technically feasible, economically viable, environmentally sound and institutional feasible (Heinimann, 2000). Around the world the forest industry is facing similar challenges in accessing wood fibre on steep terrain. Steeper slopes require alternate harvesting systems such as cable yarding, helicopter, and hand falling but these options are more expensive and much more hazardous relative to mechanized ground-based harvesting operations (Hert 2016). New machines available today can often exceed the upper slope limits established in safety codes in many countries throughout the world (Visser and Berkett 2015). Current regulations in British Columbia, for example, restrict the use of ground based logging equipment to slopes not exceeding 35 to 40% without obtaining specific approval for stability and safety concerns. Various steep-slope harvesting machines with specialized undercarriages and carriers have been shown to safely access and operate on terrain up to 70% slope (Figure 1) without “external” support or anchoring (Cavalli, 2015).

Traction devices and the undercarriage	Ground steepness (%)		
	<i>Harvesting</i>	<i>Skidding</i>	<i>Forwarding</i>
<i>Wheel with chains and band tracks</i>	35-45	35-45	30-35
<i>Triangular tracks</i>	50-70	n.c.	n.c.
<i>Integral tracks</i>	45-60	45-55	35-45
<i>“Walking” carriers (e.g. Menzi Muck)</i>	60-80	n.c.	n.c.
<i>Ground carriage (e.g. Konrad Pully)</i>	n.c.	80-100	n.c.

Figure 1. Ground steepness (%) limits for various types of forestry equipment.

Slope is not the only limiting factor, however, and while modern fully mechanised ground-based systems are a default option for safe and productive harvesting, they have always been limited by other terrain factors as well such as soil strength and/or

roughness (Amishev *et al.*, 2009). There is a limit with regard to the physical feasibility of operating machines on steep slopes (Berkett 2012) that is continuously being tested by the various stakeholders – operators, contractors, supervisors, regulators, researchers, manufacturers, etc. Continuously increasing information provides for improved knowledge and understanding, however, there has been little quantitative framework with which to evaluate the relationship between tether tension, stability, ground pressures, and slip, especially in the context of machine specifications and site operative conditions (Sessions *et al.*, 2017). Most forestry machines have relatively low Center of Gravity (CoG) and are technically very stable in their intended direction of drive, being uphill and downhill. Both the weight and also the force from the momentum created during traction loss can affect stability (Eger and Kiencke 2003).

### **3. WINCH-ASSIST DEVELOPMENTS**

#### **3.1 Winch-assist systems**

There is a huge interest and recent worldwide effort to improve traction of harvesting machines when operating on steep slopes (Amishev, 2016). One way to improve traction and stability on steep slopes is through assisting harvesting machines by winch and cable to anchor locations such as tree stumps or stationary equipment. Options for extending mechanized equipment forestry operations to steep terrain were examined as early as the 1970's through a feasibility study of a self-contained cable tether system (McKenzie and Richardson, 1978). Steep terrain winch-assist machinery for forestry have been commercially available in Europe since the 1990's and initially they were mainly used on forwarders, but since the early 2000's numerous commercial options have been developed for harvesters (Visser and Stampfer, 2015). In New Zealand, the first winch-assist system was pioneered in 2006. The subsequent developments in purpose built winch-assist machines over the last decade have led to strong growth in the application of this concept as a true harvesting system. Terms such as winch-assist, traction-assist, cable-assist and tethering all refer to technology that helps a harvesting machine climb a steep slope. Machines are not suspended from the cables and primary machines should be able to stop in full control at all times without reliance on the cable. Most winch-assist systems utilize alert devices which sounds an alarm in the operator's cab when the anchor moves.

While the concept of winch-assist is relatively simple, integrating winches and cables to machines is quite complicated and has generated different design options. Depending on various characteristics such as the location of the winch and its power source relative to the assisted (primary) machine, there are several categories that winch-assist systems can fall into (Amishev, 2016):

- Integrated winch systems: these systems have winches that are built into or bolted onto the primary assisted machines. This category includes most European-type traction-assist systems and the New Zealand-made ClimbMAX.
- Anchor machine winch systems: dedicated anchor machines are used to house and power winches that are tethered to primary assisted machines. Examples include the Remote Operated Bulldozer (ROB), EMS Tractionline, T-Mar Rhino and EcoForst T-Winch. Locating the winch assembly and electro-hydraulic components on a separate anchor machine has several advantages and disadvantages.

Major international equipment manufacturers that do not manufacture winch-assist systems but produce and supply forestry equipment have recently presented factory solutions to accommodate winch-assist systems for their equipment (Kirschenmann, 2016). Some of these include: operator station enhancements: front escape hatch for improved steep slope safety; four-point seat belt operator comfort and support while operating on steep slopes; enhanced engine and hydraulics system (reservoirs, oil tanks, sumps) grade capabilities designed for continuous 100% grade operation and intermittent 125% grade operation; engineered attachment points (hitches) that are rated at 150% of total machine mass; extended roller frames for enhance stability of the rigid track machines on steep slopes.

### **3.2 Benefits of winch-assist implementation**

Winch-assist technology offers potential for improving the safety, productivity, and efficiency of a harvesting operation (Dyson and Boswell 2016), as well as for improving felling-machine mobility and reducing soil disturbance through the reduction of slip (Visser and Stampfer, 2015). When properly implemented, winch-assist technology can provide benefits such as:

1. Safety: most contractors and users of winch-assist systems claim safety is their leading priority when implementing this technology. Mechanization of felling, bunching, shoveling, processing, skidding, etc., provides the platform for a safe and protected environment for forestry workers. Exposure to hazards is greatly reduced and the number of workers required for the same amount of harvested volume is substantially lowered.
2. Productivity: when properly planned and laid out for winch-assist implementation, productivity gains are also usually achieved. Despite the substantially higher productivity of a felling machine compared to a manual faller, the cost for the felling phase with this technology would most likely be higher. However, increased productivity during extraction phase and overall improved value recovery usually results in improved harvesting system productivity, anecdotally reported as 20%

increase overall. In addition to efficiency gains, previously non-economical stands could now be viable for harvesting through the use of winch-assist steep slope machines. These gains could have cascading effects which might improve company profile and performance.

3. Adaptability: there are a few aspects of winch-assisted technology that could improve contractor and company financial sustainability and competitiveness.
  - Quality: both delivered product quality as well as environmental performance quality. Mechanized felling and bunching provides for better directional felling and reduced tangling and breakage. Track spinning and soil disturbance (even on moderate terrain) is reduced to a minimum due to improved assisted traction, thus minimizing erosion potential. Yarding from bunched piles also results in less breakage and operator effort.
  - Worker attraction and retention: working in comfortable, air-conditioned protected modern ergonomic cabs could attract younger workers to consider a career in forestry harvesting. Improved safety, and reduced fatigue and stress have the potential to play a crucial role in retaining such workers. Improved working methods would require less effort and result in less fatigue.
  - Versatility: winch-assist technology can be used in a variety of equipment configurations that fit a contractor's suite of equipment, terrain type, piece size, labor availability (e.g. less yarder operator training required).
  - Sustainability: improved plantability and reduced planting costs will result from reduced breakage during mechanized directional felling and better tree and log positioning for yarder extraction. Less breakage will contribute to higher stand utilization and value recovery. The possibility of on-site delimiting and processing will result in less road side debris disposal and minimizing the need to burn piles.

### **3.3 Safety measures for winch-assist technology**

There had been no serious injuries or fatalities using winch-assist systems until June 2016 when a single-cable bulldozer anchor machine in New Zealand was pulled down the hill pinning the operator of the assisted felling machine under the dozer. Worldwide, there have also been several cases of cable failures (both single and double-cable systems), shackle or other connection failures, anchor failures, and machine tip-overs and rollovers without any resulting serious injuries. These close calls have been great opportunities to learn and improve. There have been several international developments in safety measures for winch-assist technology based on these recent learnings:

1. Rules, approved codes of practice, best practice guidelines:

- New Zealand has winch-assist “regulation” within the national governmental level Approved Code of Practice.
  - Several forest management companies have developed “Best Practice Guidelines”, operator training competencies, and training schedules.
  - The New Zealand Forest Industry Contractors Association is developing industry-wide best practice guidelines for operation, maintenance and inspection of winch-assist equipment.
  - FPIInnovations is developing Best Management Practices for BC conditions and supporting BC Forest Safety Council’s operator competencies and training initiative.
  - Oregon requires a special “research variance” for operating winch-assist equipment and will likely require winch-assist for any ground-based operation on slopes steeper than 50%.
  - Equipment manufacturers’ manuals and guidelines – all winch-assist equipment manufacturers provide their customers with manuals, guides, and training with varying levels of comprehensiveness. Topics may include: a) winch and cable tension monitoring and control; b) traction and stability (charts and traction coefficient identification guides; c) European winch manufacturers recommend no operation on slopes where traction cannot be maintained without the winch assistance); d) cable(s) and end connectors inspection and maintenance; e) movement sensor(s) and other safety alarms
2. Equipment manufacturers’ designs:
- Emergency back-up systems (second cable, blade or other attachment, warning devices)
  - Software solutions to spikes in tension through better synchronization between tracks and winch
  - Tension monitoring and recording
  - Lower tension in one of the two lines in twin-line systems to ensure engineering safety redundancy in case of main cable failure
  - Rated components of the whole system (2:1, 3:1, or 5:1 safety factors vary by manufacturer)
  - Controlled release vs sudden brake in case of failure.
3. Research focus:
- Terrain and soil conditions and impacts on traction and stability
  - Use of trees to change machine direction (catching)
  - Anchor types and use of blocks
  - Cable tension behaviour in relation to machine activity



- Extreme temperatures and the effects of snow and ice
- Planning and layout for winch-assist harvesting
- Remote control and teleoperation

#### **4. TELEOPERATION AND AUTONOMOUS ROBOTIC FOREST OPERATIONS**

The forest industry worldwide has been, and will be, aspiring to completely eliminate incidents during forest operations. There are several international research agencies as well as manufacturers already focusing on the mechanization of steep slope operations with visions similar to that adopted by the New Zealand Forest Owners Association's Steep Land Harvesting Program: "No worker on the slope, no hand on the chainsaw" (Cavalli, 2015). With the exponential development of technology, an integrated approach must be developed for conducting productive and injury-free mechanical harvesting operations on steep slopes that draws on the skills and accountabilities of the working team (BC Forest Safety Council, 2013). Various developments have been achieved and field-tested in the area of remote-controlled forestry equipment on challenging terrain (Figure 2) as a necessary first step, often in conjunction with winch-assist applications (Milliken and Wood, 2016). Obvious advantages of using remote control is removing the operator from hazards and also providing options for getting the machine out of a difficult situation; disadvantages would be reduced productivity and operator ergonomic comfort level in order to maintain line of site.



Figure 2. Field testing of remotely controlled winch-assist felling machine in New Zealand (Milliken and Wood, 2016)

One of the most relevant points could be the possibility to introduce the concept of "teleoperation" using unmanned ground vehicles (Milne et al. 2013). Teleoperation extends the concept of remote control even further where a machine is controlled by an operator at a remote location (no line-of-sight) with the use of cameras, sensors, and

possibly additional positioning software. Benefits of teleoperation include safe and comfortable working environment, maintained productivity and extended work-shifts, cables machines with reduced weight and lower center of gravity, opportunity to introduce semi-automation and/or multiple machine operation by a single operator (Milliken and Wood, 2016). It is important to note that teleoperation of forestry machinery is a difficult problem, primarily due to the unstructured and uncontrolled environment in which forestry harvesting takes place (Milne, 2015). Milne (2015) also reported that autonomous control using Robot Operating System (ROS) and “Minimal modelling” based system identification techniques were useful for retrofitting excavator based forestry harvesters and removing the requirement of operators to operate all the hydraulic rams of the machines. Initial prototypes have already been developed (Figure 3) and prepared for field testing in New Zealand (Milliken and Wood, 2016).

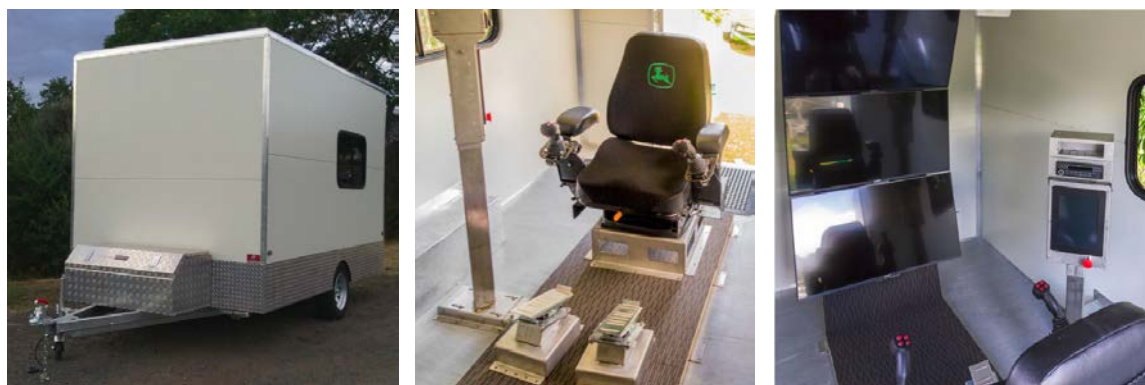

Figure 3. Initial prototype of a teleoperation forest harvesting console in New Zealand (Milliken and Wood, 2016)

Beyond a certain physical threshold of the operational site, however, the only feasible and achievable solution providing some “intelligent behaviour” to machines and systems would be the role of mechatronics application (Heinimann, 2000). Autonomous robotic forestry operations, particularly tree felling, have received significant attention and achieved advancements in recent years (Meaclem *et al.*, 2015). To successfully navigate its environment, semi-autonomous robotic devices must be capable of identifying the position, size and orientation of trees and other obstacles in the forest. Kolb *et al.* (2015) proposed an approach to identify trees using data gathered from a LiDAR scanner. Such developments will speed up the implementation of teleoperated, semi-autonomous and fully autonomous forestry equipment and, in conjunction with constantly improving winch-assist technology, will provide a platform for safely extending the range of ground-based equipment to previously infeasible terrain conditions.

## REFERENCES

- Amishev, D. (2016) “Winch-assist technologies available to Western Canada” *Technical Report No. 37*, Vancouver, B.C.: FPInnovations.
- Amishev, D., Evanson T. and Raymond K. (2009) “Felling and Bunching on Steep Terrain – A Review of the Literature” *Harvesting Technical Note HTN01-07*, Future Forests Research Limited, Rotorua, 10 pp.
- BC Forest Safety Council (2013) “Steep slope resources package. Assessing hazards and planning mechanical harvesting on steep slopes. Version 2” Nanaimo: BC Forest Safety Council
- Berkett, H. (2012) “An examination of the current slope gradients being experienced by ground-based forest machines in New Zealand plantation forests“ M. Sc. Thesis, University of Canterbury, New Zealand, 75 pp.
- Cavalli, R. (2015) “Forest Operations in Steep Terrain”. *Proceedings of the Conference CROJFE 2015 “Forest Engineering – Current Situation and Future Challenges”*, March 18–20, 2015, Zagreb, Croatia.
- Dyson, P., Boswell, B. (2016) “Winch-assisted feller-buncher equipped with a continuous-rotation disc saw: short-term productivity assessment” *Technical Report No. 46* Vancouver, B.C.: FPInnovations.
- Eger, R., Kiencke, U. (2003) “Modeling of rollover sequences” *Control Engineering Practice* 11: 209-216.
- Heinimann H.R. (2000) “Forest Operations under Mountainous Conditions” In *Forests in Sustainable Mountain Development – a State of Knowledge Report for 2000*, 224-230. Price M. F. and Butt N. eds. Wallingford: CABI Publishing
- Hert, R. (2016) “Risk management issues for mechanized harvesting” *Steep slope Conference*, Richmond, BC, March 2016.
- Kirschenmann, K. (2016) “Caterpillar forest products” *Steep slope Conference*, Richmond, BC, March 2016.
- Kolb, A., Meaclem, C., Chen, X., Parker, R., Gutschmidt, S., Milne, B. (2015) “Tree trunk detection system using LiDAR for a semi-autonomous tree-felling robot” *IEEE 10<sup>th</sup> Conference on Industrial Electronics and Applications*, June 2015, Auckland, New Zealand.
- McKenzie, D., Richardson, B. (1978) “Feasibility study of self-contained tether cable system for operating on slopes of 20–75%” *J. Terramech.* 15 (3): 113–127.
- Meaclem, C., Chen, X., Gutschmidt, S., Hann, C., Parker, R. (2015) “K-means partitioned space path planning (KPSPP) for autonomous robotic harvesting” *Int. J. of Adv. Robotic Systems* 12 (11): 1-10.

- Milliken, P., Wood, R. (2016) "Remote control and teleoperation of a cable-assisted feller buncher" *Steep slope conference*, Richmond, BC, March 2016.
- Milne, B. (2015) "Teleoperation for Steep Country Forestry Harvesting in New Zealand" PhD Thesis. Univ. of Canterbury, New Zealand, 257 p.
- Milne B., Chen X., Hann C., Parker R., Milliken P. (2013) "Design and Development of Teleoperation for Forest Machines: An Overview" In *Engineering Creative Design in Robotics and Mechatronics*. Habib M. K. and Davim J. P. eds. Hershey: IGI Global
- NZ Logger (2015) "Wired for Safety – how far can we take tethered harvesting?" *NZ Logger Magazine Special Issue*, June 2015.
- Price M. F., Gratzner G., Alemayehu Duguma L., Kohler T., Maselli D. and Romeo R. ed. (2011) "Mountain Forests in a Changing World - Realizing Values, addressing challenges" Rome: FAO/MPS and SDC.
- Sessions, J., Leshchinsky, B., Chung, W., Boston, K., Wimer, J. (2017) "Theoretical stability and traction of steep slope tethered feller-bunchers" *Forest Science* 63 (2): 192-200.
- Visser R. and Berkett H. (2015) "Effect of terrain steepness on machine slope when harvesting" *Int. J. of For. Eng.* 26 (1), 1-9.
- Visser, R., Stampfer, K. (2015) "Expanding ground-based harvesting onto steep terrain: a review" *Croat. J. of For. Eng.* 36 (2): 321-331.

## **II. ORAL PRESENTATIONS**



## O-03

### **Productivity of a harvesting operation for a small clear-cut block by direct grappling using a processor in the Kochi University Forest**

Yasushi Suzuki<sup>1,\*</sup>, Haruka Kusaka<sup>1</sup>, Yuki Yamaguchi<sup>2</sup>, Haruka Aoki<sup>2</sup>, Yoshifumi Hayata<sup>3</sup> and Hirotaka Nagai<sup>3</sup>

<sup>1</sup> Faculty of Agriculture and Marine Science, Kochi University, B200 Monobe, Nankoku, Kochi 783-8502, Japan.

<sup>2</sup> Graduate School of Integrated Arts and Sciences, Kochi University, B200 Monobe, Nankoku, Kochi 783-8502, Japan.

<sup>3</sup> Education and Research Center for Subtropical Field Science, Kochi University, B200 Monobe, Nankoku, Kochi 783-8502, Japan.

\*Corresponding author: Tel: + 81-88-864-5137 E-mail: [ysuzuki@kochi-u.ac.jp](mailto:ysuzuki@kochi-u.ac.jp)

**Abstract:** A case study was analyzed on productivity of clear cutting operation conducted by newly introduced logging machines in the Kochi University Forest. A small block of 0.2 ha is clear-cut annually to prepare a planting practice site for the Forest Science Course students. Although harvesting operations were performed by a small-scale oriented system using such as a winch-mounted mini-forwarder until 2015, an updated system has instead started to operate since 2016 with a processor equipped on a 0.25m<sup>3</sup>-class base machine and a forwarder with 3 t capacity. A series of operations was conducted, that is cutting, logging, processing, bucking, and forwarding, by the system in November 2016. The total productivity was evaluated over 4 m<sup>3</sup> person<sup>-1</sup> day<sup>-1</sup>, which was raised from that of the former system, around 2 m<sup>3</sup> person<sup>-1</sup> day<sup>-1</sup>. As of extraction operation by the processor, an angle of fell trees toward a strip road was one of critical factors on the productivity.

**Keywords:** Clear-cut, Small block, Direct grappling, Processor, Kochi University Forest

## 1. INTRODUCTION

Final cutting and appropriate regeneration are required for current man-made forests in Japan. Age distribution of the forests is concentrated around 50 years old because mass-plantation was applied around 1950s to 1970s. In the Kochi University Forest, final cutting operation of a small area, ca. 0.2 ha, has been carried out annually in order

to provide new planting area for silviculture practice of undergraduate students. To date, the officers of the University Forest performed logging operation mainly by winch-mounted mini forwarders (Nakahata et al. 2012, Birundu et al. 2016), which is just one example of typical small-scale operations in Japan. In the fiscal year 2015 the University Forest introduced a processor for 0.25 m<sup>3</sup> class excavator base machine and a 3-t forwarder and then started mechanized logging operation from the fiscal year 2016. Such a logging system is now becoming the next standard of Japanese forestry (Suzuki et al. 2010), which can be applied with a considerable density of road network. This paper reports the result of the logging operation as a case study in the current situation of Japanese forestry.

## 2. MATERIALS AND METHODS

### 2.1 Site

The Kochi University Forest is located in the middle part of Kochi Prefecture (Figure 1), southern adjacent to Reihoku Area which is famous of steep mountainous area. However, the study site has gentle terrain with the road density of 123 m/ha. A strip road runs over the cut area of 0.2 ha, of which the stand was Japanese Cedar of 40 year old.

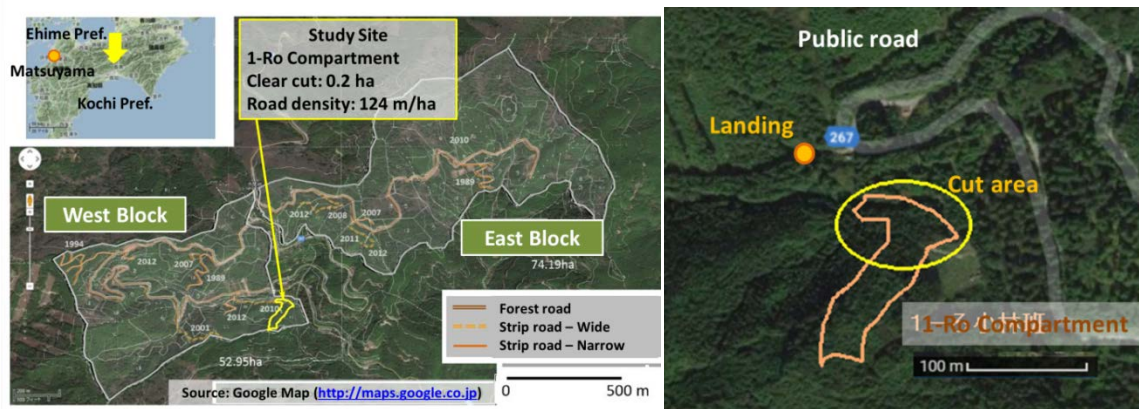

Figure 1. Study site

### 2.2 Machines and System

Two technical officers of the University Forest perform all of forest management operations such as road construction and logging. Felling was conducted by chainsaw by one person or two persons. Trees were fallen toward the strip road in order for the processor (IWAFUJI GP25V equipped on CAT308D) directly holds and extracts the trees. In case when the processor cannot reach the tree top, a forwarder (IWAFUJI U-3C) temporarily extracts the tree with a wire rope. Processed logs are bucked along



the strip road. The processor or a grapple equipped excavator (CAT 303C CR) loads the bucked logs on the forwarder. The forwarder transports the logs to the landing over a distance of ca. 300 m on the strip road. The grapple equipped excavator arranges the logs on the landing and then loads the logs on to a log truck with 3.5 t capacity which ships the logs to a log market.

### 2.3 Date and Data Collection

The felling and logging operation was conducted from November 7th to 16th, 2016. Before the operations all of standing trees were measured with diameter at breast height. Tree height and standing volume were estimated from an existing formula established for the University Forest. We investigated the operations by time study method with a video camera. Shipped volume of the logs was obtained from the log market data. Working data of the officers was also checked from the working records of the University Forest.

## 3. RESULTS AND DISCUSSION

### 3.1 Overall Usage Rate of Timber

In total 194 trees were cut. Estimated standing stem volume was 92.81 m<sup>3</sup> while the shipped volume was 71.649 m<sup>3</sup>. Some trees were left behind the site, for example, small ones or damaged ones. Overall usage rate was then calculated as 77.2 %.

### 3.2 Productivity of Felling

Average productivity of felling was 7.410 m<sup>3</sup>/person-hour (Table 1). The daily felling productivity was ranged from 4.3 to 8.8 m<sup>3</sup>/person-hour (Figure 1a). The reason of diversity was mainly weather effect. That is, felling time per tree was longer in November 8th and 9th, when the weather was rainy and with strong wind (Figure 1b).

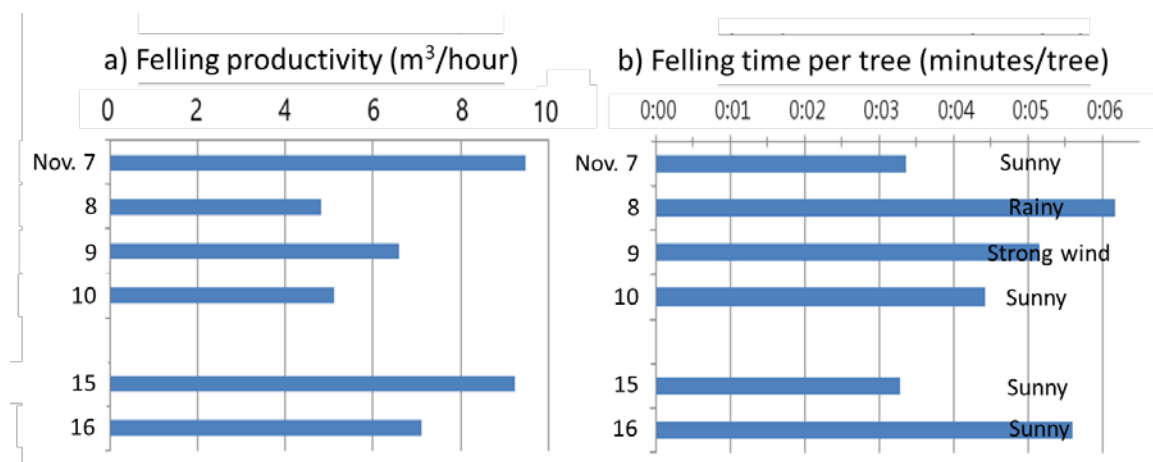

Figure 2. Productivity of felling operation

### 3.3 Productivity of Logging

Here logging operation includes extraction and processing. The total productivity of logging was 4.325 m<sup>3</sup>/person-hour (Table 1) while the daily one decreases from the first day (Figure 3). The reason is distance of extraction; felling and logging was started at the strip road side and then extended to far part of the site. However even at the road side, maneuvering of full trees by the processor sometimes required considerable time because the other side of the road was not open, that is, the remaining stand.

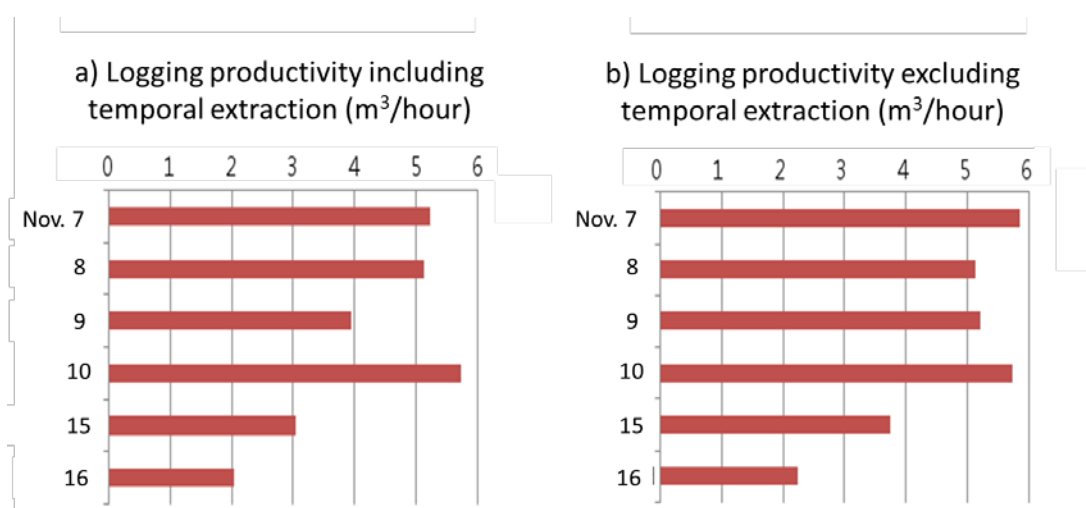

Figure 3. Productivity of logging operation

### 3.4 Overall Productivity and Improvement from Previous System

Table 1 summarizes the productivity of each process and overall productivity. Here effective working time per day is assumed as 6 hours while the total working time per day is 8 hours.

The total productivity without loading was 6.654 m<sup>3</sup>/person-day while that including loading was 4.354 m<sup>3</sup>/person-day. Because previous logging productivities at the University Forest was 1.0 to 2.3 m<sup>3</sup>/person-day (Figure 4), it is proved that the productivity was considerably improved by introducing the new system. Figure 5 (Forestry Agency, 2016) shows average productivities of logging entities, that is, logging companies and forest owners' cooperatives, in Japan, classified by yearly production per individual entity. The entities with yearly production of less than 10,000 m<sup>3</sup>, that is, smaller entities, have 2.1 m<sup>3</sup>/person-day or less productivity. Productivity of the larger ones reaches 4.7 m<sup>3</sup>/person-day. Therefore, the achievement of the present study, 4.4 m<sup>3</sup>/person-day, can be assessed as a better one compared with the current Japanese standard.

Table 1. Result of productivity

Process	Value	Unit
Felling	7.410	m <sup>3</sup> /person-hour
Extraction and Processing	4.325	m <sup>3</sup> /person-hour
Forwarding	3.504	m <sup>3</sup> /person-hour
Bucking	20.374	m <sup>3</sup> /person-hour
Other	4.976	m <sup>3</sup> /person-hour
Loading to log truck	2.099	m <sup>3</sup> /person-hour
Total without loading	1.109	m <sup>3</sup> /person-hour
	6.654	m <sup>3</sup> /person-day
Total including loading	0.726	m <sup>3</sup> /person-hour
	4.354	m <sup>3</sup> /person-day

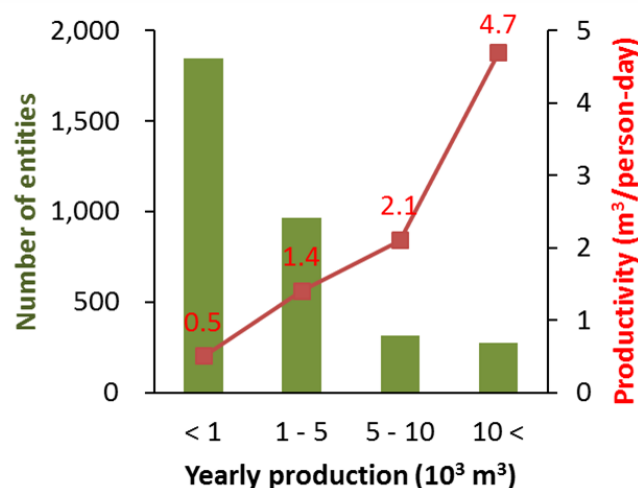
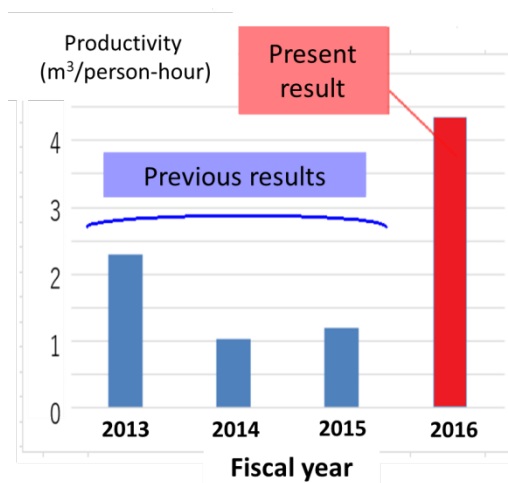

Figure 4. Improvement of logging productivity

Figure 5. Average productivities of logging entities in Japan (Forestry Agency, 2016)

### ACKNOWLEDGEMENT

This research was funded by JSPS KAKENHI Grant Numbers 15H04508 and 16K07779, and also supported by “Biomass TOSA” project of Kochi University.

### REFERENCES

Birundu, A.O., Suzuki, Y., Gotou, J., Nagai, H., Hayata, Y., Yamasaki, S., and Yamasaki, T. (2016) “Assessing the possibility of incorporating Japanese smallscale logging systems into forest operations in Kenya.” *Arkadiusz Gendek and Tadeusz Moskalik*

(Eds.) *Proceedings and Abstracts of FORMEC, the 49th Symposium on Forest Mechanization – From Theory to Practice: Challenges for Forest Engineering –*. 337pp, Faculty of Forestry, Department of Forest Soil and Sciences, Warsaw University of Life Sciences – SGGW, Warsaw, Poland., 4-7 September 2016, Warsaw, Poland: 99-103.

Forestry Agency (2014) *Annual Report on Forest and Forestry in Japan Fiscal Year 2013 (Summary)*, Ministry of Agriculture, Forestry, and Fisheries (MAFF), Tokyo, 33pp. Online,

(<http://www.rinya.maff.go.jp/j/kikaku/hakusyo/25hakusyo/pdf/h25summary.pdf>).

Accessed on July 6th, 2017.

Forestry Agency (2016) *Annual Report on Forest and Forestry in Japan Fiscal Year 2015*, Ministry of Agriculture, Forestry, and Fisheries (MAFF), Tokyo, 243pp. Online, (<http://www.rinya.maff.go.jp/j/kikaku/hakusyo/27hakusyo/index.html>). Accessed on May 25th, 2016 (in Japanese).

Nakahata, C., Aruga, K., Uemura, R., Saito, M. and Kanetsuki, K. (2014) “Examining the optimal method to extract logging residues from small-scale forestry in the Nasunogahara area, Tochigi prefecture, Japan.” *Small-scale Forestry* 13, 251–266.

Suzuki, Y., Gotou, J., Yamauchi, J. and Ohara, T. (2010) “A case study on operational efficiency of downward felling, direct logging and winching operation on Hinoki plantation forest with dense road network and prospected effect of upward felling.” *Journal of the Japan Forest Engineering Society*, 25, 91-96 (in Japanese).

## O-04

### **Productivity and Harvesting of Exotic Tree Plantations on Highland in Chiang Mai, Thailand**

Wathinee Suanpaga<sup>1\*</sup>, Nopparat Kaakkurivaara<sup>2</sup>, Khanchai Prasana<sup>2</sup>, Venus Tuankrua<sup>3</sup>  
and Supattra Thueksathit<sup>3</sup>

<sup>1</sup>Department of Silviculture, Faculty of Forestry, Kasetsart University, Bangkok 10900

<sup>2</sup>Department of Forest Engineering, Faculty of Forestry, Kasetsart University, Bangkok 10900

<sup>3</sup>Department of Conservation, Faculty of Forestry, Kasetsart University, Bangkok 10900

\* Corresponding author; E-mail: [wathinee.s@ku.ac.th](mailto:wathinee.s@ku.ac.th)

**Abstract:** The establishment of exotic tree plantations had been promoted in the highlands of Thailand to supply roundwood and combat environment degradation in the wake of deforestation. The productivity, harvesting intensity and methods with appropriate and environmental friendly was studied in 30-year-old exotic tree plantations with spacing of 2 m x 2.5 m at Ang Khang Royal Agricultural Station, Chiang Mai province. This plantation was composed of six exotic tree species and 26 indigenous tree species with an average tree density of 1,450 trees ha<sup>-1</sup> and an average standing volume of 282.98 m<sup>3</sup> ha<sup>-1</sup>. The most suitable harvesting level was 20% of basal area and the most appropriated logging system with the least impact on plant, wildlife, and water resource was chain saw and log chute extraction. This information can be used for sustainable forest management including forest harvesting impact management.

**Keywords:** Sustainable Forest Management, Forest Harvesting, Exotic Tree Plantation, Highland

#### **1. INTRODUCTION**

In the highlands of Thailand, the deforestation resulted in severe shortages of water and wood resources. The Royal Project Foundation has attempted to promote reforestation in these areas for more than 30 years. Nowadays, the growing wood demand of villagers cannot be met by the sustainable forest management and harvesting of forest plantations. Timber harvesting on steep terrain is to be more expensive and complicated than timber harvesting on flat terrain. In addition, the environmental effects

of timber harvesting are great importance in selecting a harvesting system and planning logging operations in highlands. Three aspects should be equally taken into account when selecting the most suitable harvesting systems: technical, economics, and environmental feasibilities. Thus, the effect of different harvesting intensities was studied with the appropriate and environmental friendly timber harvesting.

## **2. MATERIALS AND METHODS**

The study was conducted in exotic tree plantation planted in 1983 and 1984 at Doi Angkhang, Fang district, Chiang Mai province, Thailand (N 19° 51' 02"- N 19° 56' 00", E 99° 01' 27"- E 99° 04' 25"). The four main tree species planted in the plantation were *Acacia confusa*, *Fraxinus griffithii*, *Liquidambar formosana*, and *Cinnamomum camphora*. Three harvesting intensity levels (no harvesting, 20%, and 40% of basal area) were applied in the study area using 40 m x 40 m in plot size with three plots or replications. Species diversity, density, volume, basal area, leaf area index (LAI), and canopy cover of trees were compared before and after harvesting. The selection of the most suitable logging system started with gathering all possible logging systems considering their technically and economic feasibility, environmentally impact and social acceptability. Subsequently, the selected logging systems were carried out in the studied plantation to examine the productivity and operating cost of each system together with their impacts on plants, wildlife, and water quality from June until October 2015. The data were analyzed by using analysis of variance (ANOVA) and then compare means by Duncan's new multiple range test (DMRT).

## **3. RESULTS AND DISCUSSION**

The results in Table 1 showed that forest stands did not differ significantly ( $p > 0.05$ ) before harvesting, except tree density ( $p \leq 0.05$ ). After harvesting, canopy cover of 40% harvesting plot were significant difference ( $p \leq 0.05$ ) from 20% harvesting plot and no harvesting plot, while tree density and LAI of 40% harvesting plot were significant difference ( $p \leq 0.05$ ) from no harvesting plot. The impacts on plant diversity, water quality, and wildlife diversity among three harvesting intensities were not significantly different ( $p > 0.05$ ) (Table 2).

Three suitable logging systems composed of manual tree felling and cross cutting together with manpower extraction, animal extraction, and log chutes extraction (Table 3). Manual timber extraction provided moderate productivity and operating cost, however, contributed the greatest negative impact on soil surface. Soil erosion may occur as a consequence of opened soil surface. Thus, manual timber extraction should be avoided when operating on steep terrain. Animal timber extraction did not affect soil,

but it offered the lowest productivity and highest operating cost compared to other systems. Based on these results, timber extraction by log chutes was the most suitable logging systems under given circumstances. It offered the highest productivity with the cheapest operating cost. No evidence was found the impact on soil by applying of log chutes.

**Table 1** Plant community characteristic of mixed forest plantation among three harvesting intensities.

Item	Time	Harvesting intensity			p-value (ANOVA)
		0%	20%	40%	
Species richness (number of species)	Before	17 <sup>a</sup>	17 <sup>a</sup>	15 <sup>a</sup>	0.910 <sup>ns</sup>
	After	17 <sup>a</sup>	16 <sup>a</sup>	15 <sup>a</sup>	0.912 <sup>ns</sup>
Tree density (individual ha <sup>-1</sup> )	Before	1,237 <sup>b</sup>	1,493 <sup>a</sup>	1,356 <sup>ab</sup>	0.045*
	After	1,237 <sup>a</sup>	1,300 <sup>ab</sup>	1,043 <sup>b</sup>	0.033*
Basal area (m <sup>2</sup> ha <sup>-1</sup> )	Before	38.89 <sup>a</sup>	42.88 <sup>a</sup>	41.36 <sup>a</sup>	0.673 <sup>ns</sup>
	After	38.14 <sup>a</sup>	35.30 <sup>a</sup>	27.01 <sup>a</sup>	0.074 <sup>ns</sup>
Volume (m <sup>3</sup> ha <sup>-1</sup> )	Before	258.76 <sup>a</sup>	239.27 <sup>a</sup>	267.27 <sup>a</sup>	0.768 <sup>ns</sup>
	After	253.90 <sup>a</sup>	235.49 <sup>a</sup>	166.28 <sup>a</sup>	0.140 <sup>ns</sup>
Leaf area index	Before	2.297 <sup>a</sup>	2.124 <sup>a</sup>	2.154 <sup>a</sup>	0.497 <sup>ns</sup>
	After	2.297 <sup>a</sup>	2.061 <sup>ab</sup>	1.707 <sup>b</sup>	0.018*
Crown cover (%)	Before	82.944 <sup>a</sup>	83.060 <sup>a</sup>	83.952 <sup>a</sup>	0.791 <sup>ns</sup>
	After	82.944 <sup>a</sup>	82.132 <sup>a</sup>	77.299 <sup>b</sup>	0.021*

<sup>ns</sup> = no significant difference at p-value > 0.05, \* = significant difference at p-value ≤ 0.05, Data in the same row followed by the same superscript letter(s) were not significant different

**Table 2** Impact of harvesting on plant diversity, water resources, and wildlife diversity.

Impact	Time	Harvesting intensity			p-value (ANOVA)
		0%	20%	40%	
<b>Plant</b>					
Diversity index of saplings	Before	2.31 <sup>a</sup>	1.90 <sup>a</sup>	2.24 <sup>a</sup>	0.152 <sup>ns</sup>
	After	2.34 <sup>a</sup>	1.85 <sup>a</sup>	2.00 <sup>a</sup>	0.292 <sup>ns</sup>
Diversity index of seedlings	Before	1.75 <sup>a</sup>	2.22 <sup>a</sup>	2.28 <sup>a</sup>	0.401 <sup>ns</sup>
	After	1.84 <sup>a</sup>	2.10 <sup>a</sup>	2.22 <sup>a</sup>	0.658 <sup>ns</sup>
<b>Water</b>					
Temperature (°C)	Before	18.25 <sup>a</sup>	18.50 <sup>a</sup>	18.85 <sup>a</sup>	0.522 <sup>ns</sup>
	After	19.30 <sup>a</sup>	18.35 <sup>a</sup>	19.00 <sup>a</sup>	0.314 <sup>ns</sup>
Dissolved oxygen (mg l <sup>-1</sup> )	Before	7.50 <sup>a</sup>	7.83 <sup>a</sup>	7.41 <sup>a</sup>	0.253 <sup>ns</sup>
	After	7.00 <sup>a</sup>	7.20 <sup>a</sup>	6.65 <sup>a</sup>	0.061 <sup>ns</sup>
Turbidity (NTU)	Before	2.65 <sup>a</sup>	1.48 <sup>a</sup>	1.81 <sup>a</sup>	0.734 <sup>ns</sup>
	After	5.14 <sup>a</sup>	1.83 <sup>a</sup>	2.09 <sup>a</sup>	0.231 <sup>ns</sup>
<b>Wildlife<sup>1</sup></b>					
Diversity index of birds	Before	3.902			
	After	3.616			
Diversity index of mammals	Before	1.430			
	After	1.611			
Diversity index of reptiles	Before	2.871			
	After	1.098			
Diversity index of amphibians	Before	1.524			
	After	1.231			

<sup>ns</sup> = no significant difference at p-value >0.05, <sup>1</sup> = data from inventory in the whole study area



**Table 3** Productivity, cost and soil bulk density of logging systems.

<b>Items</b>	<b>Manual tree felling and cross cutting</b>	<b>Manpower extraction</b>	<b>Animal extraction</b>	<b>Log chutes extraction</b>
Mean time consumption (min cycle <sup>-1</sup> )	12.70	0.86	12.83	0.26
S.E.	0.86	0.03	0.46	0.01
S.D.	11.41	0.48	2.09	0.15
Variance	130.13	0.23	4.37	0.02
N	178	357	21	790
Productivity (m <sup>3</sup> hr <sup>-1</sup> )	1.34	1.18	0.45	2.73
Cost (THB m <sup>-3</sup> )	105.57	132.53	399.11	61.02
Soil bulk density (g cm <sup>-3</sup> )		0.14	0.15	0.14

The results clearly showed that the low harvesting intensity applied by manual tree felling and cross cutting together with log chutes extraction had little impact on forest stand characteristics, echoing the findings of McDonald *et al.* (2008), Wu *et al.* (2016). Moreover, its impact on water quality and wildlife were minimal similarly to the result of Forron *et al.* (1998), Semlitsch *et al.* (2009), Webb *et al.* (2007), and Reinert *et al.* (2011).

#### **4. CONCLUSION**

In the exotic plantations in the highlands of Thailand, the appropriate harvesting intensity was 20% of basal area and the logging system with the least impact on plant, wildlife, and water resource was chain saw and log chute extraction.

#### **ACKNOWLEDGEMENT**

This research was supported by National Research Council of Thailand.

#### **REFERENCES**

- Forron, J., Potvin, F., and Dussault, C. (1998) "Short-term effects of logging on snowshoe hares in the boreal forest." *Canadian Journal of Forest Research*, 28, 1335-1343.
- McDonald, R. I., Motzkin, G., and Foster, D. R. (2008) "The effects of logging on vegetation composition in western Massachusetts." *Forest Ecology and Management*, 255(12), 4021-4031.
- Reinert, H. K., Munroe, W. F., Brennan, C. E., Rach, M.N., and Pelesky, S. (2011)

- “Response of timber rattlesnakes to commercial logging operation.” *Journal of Wildlife Management*, 75, 19-29.
- Semlitsch, R. D., Todd, B. D., Blomquist, S. M. Calhoun, A. J. K., Gibbons, J. W., Gibbs, J. P., Graeter, G. J., Harper E. B., Hocking, D. J., Hunter, M. L., Patrick D. A., Rittenhouse, T. A. G. and Rothermel, B. B. (2009) “Effects of timber harvest on amphibian populations: understanding mechanisms from forest experiments.” *Bioscience*, 59, 853-862.
- Webb, A. A., Jarrett, B. W. and Turner, L.M. (2007) “Effects of plantation forest harvesting on water quality and quantity: Canobolas State forest, NSW.” *Proceedings of the 5<sup>th</sup> Australian Stream Management Conference*. 443-448.
- Wu, Z., Su, D., Niu, L., Lewis, B. J., Yu, D. Zhou, L., Zhou, W., Wu, S. and Dai, L. (2016) “Effects of logging intensity on structure and composition of a broad-leaf Korean pine mixed forest on Changbai mountains, Northeast China.” *Chinese Geographical Science*, 26(1), 59-67.

## O-05

### Forwarding Operation Using a Tractor and a Trailer in Mountainous Forest

Masahiro Iwaoka<sup>1,\*</sup>, Yoshihiro Suzuki<sup>2</sup> and Takeshi Matsumoto<sup>1</sup>

<sup>1</sup> Institute of Agriculture, Tokyo University of Agriculture and Technology, 3-5-8, Saiwai-cho, Fuchu-shi, Tokyo 183-8509, Japan.

<sup>2</sup> Formerly Faculty of Agriculture, Tokyo University of Agriculture and Technology, 3-5-8, Saiwai-cho, Fuchu-shi, Tokyo 183-8509, Japan, current Kyoto local office, Yamanashi Prefectural Government, 1239-1, Enzankamishiogo, Koshu-shi, Yamanashi 404-8601

\*Corresponding author: Tel: + 81-42-367-5880 E-mail: [iwaoka@cc.tuat.ac.jp](mailto:iwaoka@cc.tuat.ac.jp)

**Abstract:** A Valtra A93 High Tech tractor with a Farmi Vario 101 trailer was tested to evaluate its forwarding ability in a mountainous forest. Stopwatch time study was carried out by measuring the loading volume, driving velocity and fuel consumption in relation to road inclination. The results showed that the driving velocity of the loaded forwarder was fastest on level trails and it became lower on uphill of 3 degrees or more, and on downhill of 5 degrees or more. The driving velocity of the unloaded forwarder reduced at uphill of 4 degrees or more, however, it did not decline during downhill driving. The productivity of using a grapple loader on an external excavator for unloading operation was higher than that of using a grapple loader on the trailer, however, the operational cost of unloading with an external excavator was also higher, because of the high machine cost of an external excavator.

**Keywords:** Driving velocity, Fuel consumption, Loading volume, Operation cost, Road inclination

#### 1. INTRODUCTION

Forwarding operations using a tractor-trailer combination is popular in Europe, however it is rare in Japan. Because a tractor with a trailer is not suitable for steep road pitches nor backward driving, and requires extraction trails and U-turn spaces or a circuit road, which are difficult to construct on a steep slope.

A Valtra A93 High Tech tractor with a Farmi Vario 101 trailer was tested to clarify its forwarding ability in a mountainous forest. A stopwatch time study was carried out

and loading volume, driving velocity and fuel consumption were measured in relation to road inclination.

## 2. METHODS AND MATERIALS

The tested tractor was a Valtra A93 HiTech made in Finland with a power rating of 73.6 kW (Table 1) equivalent to 13 t class excavators, which are familiar in the Japanese forestry industry. It can drive on narrow skidding trails with its narrow width of 2.2 meters. The combined trailer was a Farmi Vario 101 with Farmi 4571 loader crane made in Finland.

Table 1. Specifications of Valtra A93, Farmi Vario 101 and IHI F801

	A93	Vario 101	F801
Manufacturer	Valtra	Farmi	IHI
Power (kW)	73.6	—	120
Max speed (km/h)	40	—	7/14 (L/H)
Width (mm)	2,195	2,210	2,270
Weight (full tanks, kg)	3,750	1,580	9,100
Loading area length (mm)	—	3,890	3,110
Loading area width (mm)	—	2,090	2,020
Load capacity (t)	—	11	4.5

Observations were made at sub-compartment “ri”6 of compartment 415 of Yamanashi prefecture forest (Fujiyoshida-shi) on 6th and 22nd September 2014, and at sub-compartment “ha”16 of compartment 409 on 17th and 26th December and 22nd April 2015. Figure 1 shows the terrain and extraction trails of these stands. About 650 to 950 meters downhill forwarding including a short uphill drive was conducted in the compartment 415, while about 2,000 to 2,250 meters uphill forwarding was carried out in the compartment 409. Loading operations were done with the loader crane on the trailer. 14 cycles of all 17 unloading operation cycles of uphill forwarding and all unloading operations of downhill forwarding were done with the loader crane on the trailer and the other cycles were done by a grapple loader (Kesla) on an excavator (Hitachi Xaxis 70).

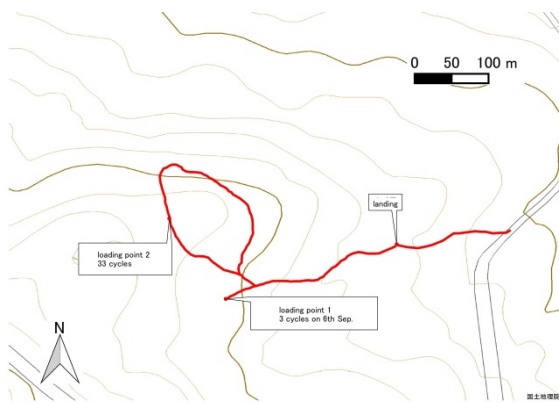

Sub-compartment "ri"6 of compartment 415  
of Yamanashi prefecture forest in  
Fujiyoshida-shi

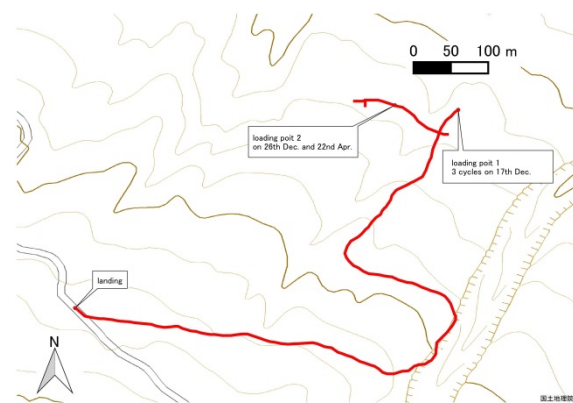

Sub-compartment "ha"16 of compartment  
409

Figure 1. Terrain and extraction trails of observation stands

A stopwatch time study was carried out on loading and unloading operations to evaluate the capacity of the forwarder (tractor and trailer) and these operations were recorded using a video camera. The length and small end diameters of all logs on the trailer were measured to calculate loaded volume at each cycle. Driving velocity of the forwarder was measured with GPS receiver and extraction trails were measured using compass survey. Fuel consumption of the tractor was measured using the tractor's function on 22nd September, 26th December and 22nd April, and full tank method was carried on 22nd September at the same time. Furthermore, a flowmeter was used on 17th December and 26th December morning. After that, the flowmeter did not function properly.

### 3. RESULTS AND DISCUSSION

A total 16 downhill forwarding trips were made and 449 logs of 70 cubic meters were extracted, while 17 uphill forwarding trips were made and 260 logs of 69 cubic meters were extracted. Therefore, overall number of forwarding trips was 33 and 709 logs of 139 cubic meters were extracted. Figure 2 shows loaded volume of each forwarding. The loaded volumes of 3 uphill forwardings on 17th December were significantly less than the others, because the road surfaces were iced on that day. The mode of the loaded volumes other than that day was at the bin of 4.4 to 4.6 cubic meters, and the average was 4.4 cubic meters. There were 8 variety of log length: 2.0, 3.0, 3.3, 3.4, 3.6, 3.9, 4.0, 5.0 meters. The loading and unloading times were directly proportional to the number of loaded logs, because the length of 509 out of 709 loaded logs were 4.0 meters. The

loading time  $T_{ld}$  (seconds), the unloading time using the grapple loader on the trailer  $T_{us}$  (seconds) and the unloading time using the grapple loader on the external excavator  $T_{ue}$  (seconds) were described by equations (1), (2) and (3) respectively.

$$T_{ld} = 12.2n + 464 \quad (1)$$

$$T_{us} = 17.1n + 363 \quad (2)$$

$$T_{ue} = 7.50n + 98 \quad (3)$$

Here,  $n$  is the number of loaded logs at each forwarding cycle.

The driving velocity related to road inclinations. The driving velocity of the loaded forwarder reached the fastest speed of 2.5 meters per second on level trails; it became slower and was about 1.6 meters per second on uphill of 3 degrees or more, and on downhill of 5 degrees or more. From here, the same gear position was assumed to be used during uphill and downhill driving. The driving velocity of the unladen forwarder was reduced at uphill of 4 degrees or more, however, it did not change on downhill driving.

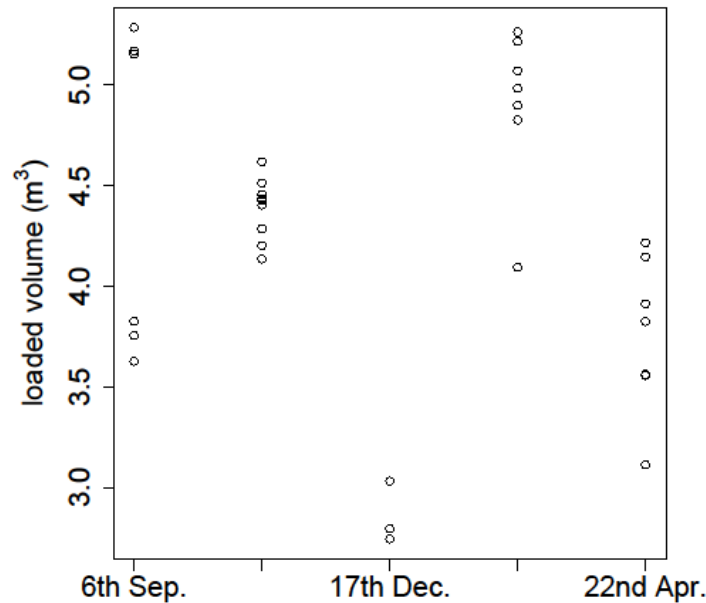

Figure 2. loaded volume

The fuel consumption was proportional to working time; the fuel consumption ratio of unladen drive, loaded drive, loading and unloading were 1.4, 3.0, 1.3 and 2.2 cubic centimeters per second respectively.

The productivity of forwarding operations was calculated from these results in a

relation to forwarding distance (Figure 3). The productivities depended on unloading equipment and trail inclination and in the legends, “grapple on trailer” means that unloading operations were done with a grapple loader on the trailer, “grapple on excavator” means that the operations were done with a grapple loader on an external excavator, and “level”, “10 degrees uphill” and “10 degrees downhill” indicate trail inclinations.

This figure shows that the productivity is highest in level forwarding and the productivity of uphill forwarding is higher than downhill on relatively gentle terrain of 10 degrees trail inclination. This is because the driving velocity of unladen forwarder become lower in uphill driving while that does not change in downhill driving. The productivity of using a grapple loader on an external excavator for unloading operation is higher than that of using a grapple loader on the trailer, however, this advantage becomes smaller as the forwarding distance increases.

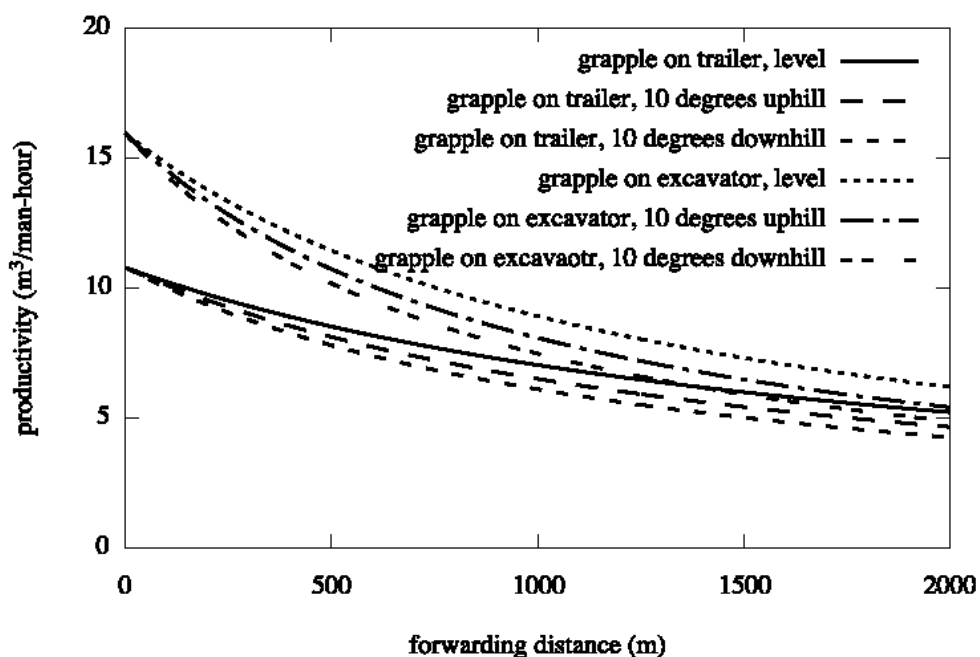

Figure 3. Relationship between forwarding distance and productivity

Figure 4 shows the relationship between forwarding distance and operation cost. The lowest operational cost appears in level forwarding with a grapple loader on the trailer for unloading operation. The operational cost of using a grapple loader on the trailer for unloading operation is lower than that of using a grapple loader on an external excavator. This implies that the machine cost of an external excavator is larger than the reducible cost by high productivity.

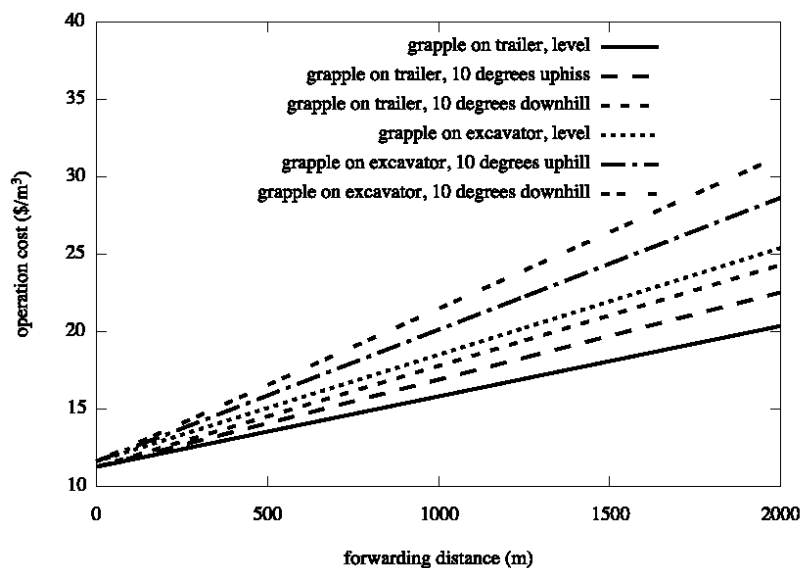

Figure 4: Relationship between forwarding distance and operation cost

#### 4. CLOSING

A Valtra A93 High Tech tractor with a Farni Vario 101 trailer was tested to evaluate its forwarding ability in a mountainous forest. The results show that the driving velocity was related to road inclinations. Although the driving velocity of the loaded forwarder was fastest on level trails, it became slower on uphill slopes of 3 degrees or more, and on downhill slopes of 5 degrees or more. The driving velocity of the unladen forwarder was reduced at uphill slopes of 4 degrees or more, however, it remained constant on all downhill slopes. The fuel consumption was proportional to operation time. The productivity of using a grapple loader on an external excavator for unloading operation is higher than that of using a grapple loader on the trailer. On the contrary, the operational cost of using a grapple loader on the trailer for unloading operation is lower than that of using a grapple loader on an external excavator. This is because the machine cost of an external excavator is larger than the reducible cost by high productivity.



**O-07**

## **A New Small Yarding System for Log Transportation**

H. Hulusi ACAR<sup>1</sup>

<sup>1</sup> Karadeniz Technical University, Trabzon/Turkey

E-mail: [hlsacar@ktu.edu.tr](mailto:hlsacar@ktu.edu.tr)

**Abstract:** Today, the damages at residual stand and quality/quantity losses on wood of log extraction activities is above acceptable level. Therefore, it is important to develop new methods and techniques to minimize these losses. In Turkey, forest cable yarding systems are the only system that allows transportation on cable of logs without touching the ground. However, these systems have various disadvantages such as imported, very expensive, long installation/disassembly, requiring the opening of transport corridors in the forest and not being rentable when the amount of transported wood is under a certain amount. While the number of forest yardings in Turkey has been over 50 in the 1980's, new ones have not been purchased due to these disadvantages and only a few are left today. This brings the agenda to the development of a new portable system which is affordable by those engaged in forest harvest and minimizing both environmental damage and economic loss. The aim of this study is to develop a mini yarding system which is enable the logs to be transported up the slope, non-tower, easy to install and use, cheaper and more ergonomic than alternative systems. The system consists of a carriage produced in the industry and a forest tractor, and it can carry on the cable logs up to 300m. A portable hand crane or truck-mounted crane can be used in this developed system for power supply at.

**Keywords:** Log, Carriage, Small yarding, Environment-friendly transport techniques

### **1. INTRODUCTION**

Most of the production activities of wood raw materials are; Harvest, primer transport and secondary transport. Primer transport activity is particularly high in countries where the use of technology is limited; Technical, economic, ergonomic and environmental aspects. In Turkey, an average of 300 million logs are produced annually, and these logs are transported on an average of 800 meters from the forest to the edge of the forest road (Acar, 2016). Subdivision activities are carried out by approximately 90% on ground sliding techniques.

The fact that forests in our country are generally located on steep terrain and that modern production machinery is not sufficient cause the woodchamps to suffer various quality and quantity losses during riding. Many studies have been carried out on the ground during the skidding activity on the ground in the remaining trees (Spinelli, 1999; Pereira et al., 2002; Bozic, 2003; Yilmaz and Akay, 2008; Ünver and Acar, 2009a) ; Hosseini, 2000) and forest soil (Nugent et al., 2003; Landsberg et al., 2003).

In the Eastern Black Sea Region, during the cutting and logging processes in the wood production areas, it has been shown that there is a volume loss of 15-17% and a quality loss of 10% (Gürtan, 1975). It has been determined that quality losses occurring in the raw materials of the wood during the harvesting activities cause a reduction of 40% in the material value of the trees (Murphy and Twaddle, 1985). It has been found that during skidding activities on slopes, various damage such as breakage (50%), fringing (45%) and cracking (5%) occur in logs (Ünver and Acar, 2009b).

For Turkey, which is unable to meet the demand of the industrial wood raw materials of the market, this loss should definitely not be allowed. In addition, in recent years attention has been drawn to the increase in the environmental sensitivity of the society and the detection and reduction of damages caused by the remaining forests of the divestment activities, which are direct intervention in the forest.

It is more economical, environmental and ergonomic in terms of transportation of products from the air to different systems in areas where the moving distance is long, many products are present, the land structure is defective or the environment is preliminary (Dykstra and Heinrich, 1996; FAO, 1998).

With yarding systems, they can be transported either on the ground or entirely on the cable. Thus, both loss of quality and quantity of the woods transported as a result of friction or collision are reduced and damage to the remaining stand is minimized (Coşkun and Bilgin, 2010). For this reason, the development of techniques suitable for the conditions of the countries that minimize the losses that may occur in the market is important both in terms of meeting the market demand and minimizing the environmental damage.

The only system used for air transportation of logs in Turkey is the cranes forest yardings. However, yardings; They have various disadvantages such as being too expensive, taking a long time for assembly / disassembly and not being efficient when there is no wood to be transported over a certain amount.

While the number of forest yardings in Turkey has been over 50 in the 1980's, new ones have not been purchased due to these disadvantages and only a few remain today. This situation is more economical than their existing ones, cutting down on wood ground and bringing to the development of a portable system that will minimize damage to both the remaining forest and the moving country.

The purpose of this study is; Especially the development of a carriage with a mini yarding system that is not tower-mounted, which is practical for installation and use, cheaper than alternative systems, which will enable logs to be transported by air from the side of the road.

## 2. ALTERNATIVE MINI YARDING

The system consists of a carriage produced by the industry, 10-12 mm diameter and 300 m long steel core cable, cer cable, directional rollers and a forest trailer to provide the pulling power. In this developed system, there is no tower except the existing crane. Instead, it benefited from a direction pulley mounted the stand tree (Figure 1).

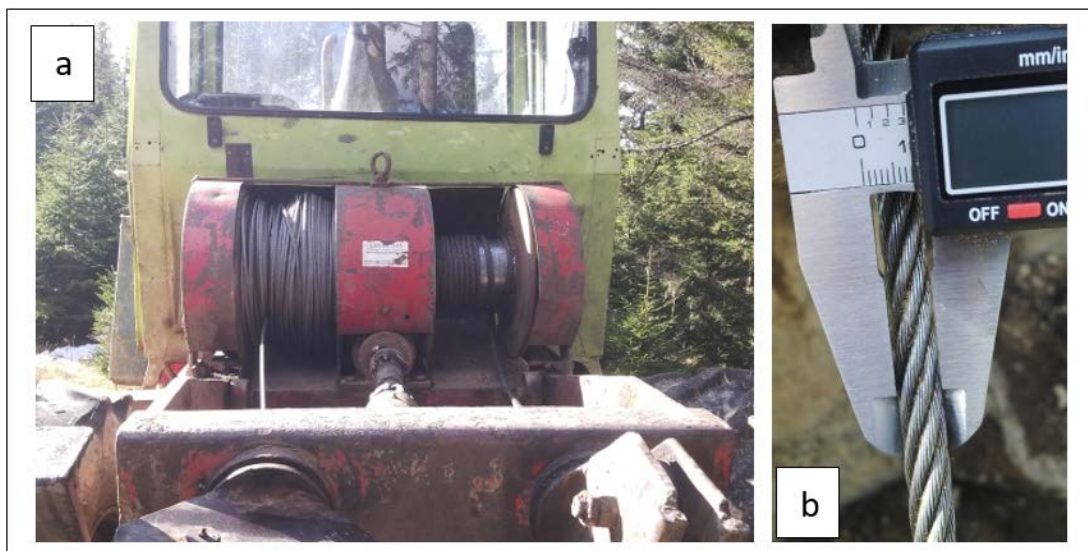

Figure 1. Mini yarding components. Forest tractor (a), main cable (b)

The carriage was specially produced by Trabzon Organized Industrial Center (Figure 2).

In this study, the system is powered by a MB Trac 900 model forest tractor. In the mini yarding, an upright corridor with an average length of 4 meters is opened between the place where the logs are stored and the forest tractor where the power is provided, or it can be installed without opening the corridor in a suitable route in the forest. A carriage made of artificial material is mounted on a 10-12 mm diameter steel core cable which is connected to the drum of a core forest tractor. The end of the main cable is pulled out of the opened corridor and brought to the lower station where the logs are stored and secured by connecting to the right and left trees with the help of direction pulleys (Figure 3).



Figure 2. The Carriage



Figure 3. Installation of mini yarding

### 3. DISCUSSION AND CONCLUSIONS

In Turkish forestry, that is belong to the government 99 % of all forests, skidding of logs can be transported down the slope by primitive methods. However, there are few limited and expensive methods in the country forest where the private sector does not develop, in order to carry the logs up the slope in areas where the forest roaved network is not enough.

In this respect, it is important to develop a portable and cheap yarding (Acar MHH300) system.

This research was conducted in Mountainous Eastern Black Sea Region at the field condition formed *Picea orientalis* Forest in the spring 2016 by this yarding using. Controlled pulling to upward by using tractor engine power was taken essential. Based on this study, drawing speed and efficiency on the motor system were found 1,5 m/h and 3,057 m<sup>3</sup>/h, respectively. Average skidding distance was 140 meter in the case. The log diameters are between 25 and 42 cm. The transport slope is 60 percent and carried out mounting/dismounting time by 2 workers. The carriage producing cheaper as average 500 US dollars (Acar, 2016).

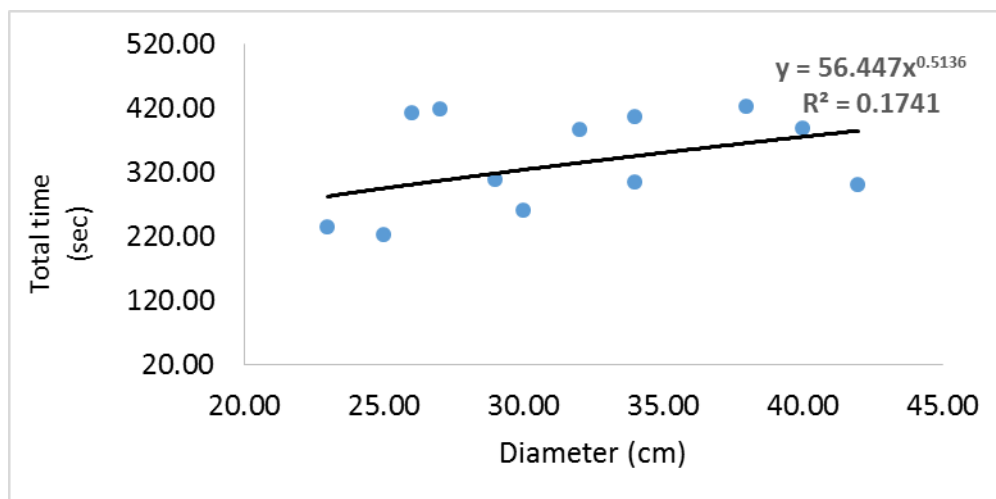

**Figure 4.** Regression between log diameter and total pulling time

- It is possible to save the time by removing the mini yarding both up and down the slope. This system enhances productivity, contributes to meeting the market demands of the market, and minimizes the damage to the market. Thus, this system provides significant economic contributions.
- Technical aspects; It has advantages such as being portable, installation / dismantling takes much shorter time compared to other yardings, no need for a trained operator and no spare part troubles due to local resources.
- The system is friendly to the environment in terms of minimizing the need for artificial route to the forest or installing it through the spaces between the trees in the forest.
- It is useful because it is an ergonomic tool in areas where labor is socioeconomic and it makes forestry work more attractive. And also it contributes to less fatigue

of near 300 000 forest workers working in wood production in our country and reduction of work accident risk.

- To increase the towing capacity of the mini yarding system, the cable can be wound double in the vineyard drum. Especially; instead of keeping and using expensive and inefficient forest yardings in the forest ramps that carry 1-2 trucks a day, it is an important alternative.
- When considering the difficulty of developing tools and methods in forestry removal studies, the system can be developed by working on this system which may be common and recycled.

## REFERENCES

- Acar, H.H., 2016. Orman İçinde Tomruk Transportu İçin Bir Mini Hava Hattı AcarMHH300 Sisteminin Geliştirilmesi, BAP Araştırma Projesi, 5364.
- Bozic, T., 2003. Impact of Forest Harvesting, Alberta Government, Agriculture, Food and Rural Development, November 28.
- Coşkun, K., Bilgin, F. 2010. Artvin Orman Bölge Müdürlüğü Odun Hammaddesi Üretim Çalışmalarının Mekanizasyon Açısından Değerlendirilmesi. Artvin Çoruh Üniversitesi Orman Fakültesi Dergisi. Cilt: II, 587-597.
- Dykstra, D., Heinrich, R. 1996. FAO Model Code of Forest Harvesting Practice, FAO, Rome, 85p.
- FAO, 1998. Reduced Impact Timber Harvesting in the Tropical Natural Forest in Indonesia. Forest Harvesting Case-Study 11. Rome.
- Gürtan, H., Dağlık ve Sarp Arazili Ormanlarda Kesim ve Bölmeden Çıkarma İşlerinde Uğranılan Kayıpların Saptanması ve Bu İşlerin Rasyonalizasyonu Üzerine Araştırmalar, TÜBİTAK Yayın No 250, T.O.A.G. Seri No 38, Ankara, 1975.
- Hosseini, S.M., Madjnonian, B., Nieuwenhuis, M., 2000. Damage to Natural Regeneration in the Hyrcanian Forests of Iran: A Comparison of Two Typical Timber Extraction Operations, Journal of Forest Engineering, 11, 2.
- Landsberg, J.D., Miller, R.E., Anderson, H.W. ve Tepp, J.S., 2003. Bulk Density and Soil Resistance to Penetration As Affected by Commercial Thinning in Northeastern Washington, Res. Pap. Portland, or: U.S. Department of Agriculture, Forest Service, Pacific Northwest Research Station, Washington.
- Murphy, G. and Twaddle, A.A., 1985. Techniques for the Assessment and Control of Log Value Recovery in the New Zealand Forest Harvesting Industry, in: Proceedings of the 9th Annual Meeting of Council on Forest Engineering, Mobile, Al.

- Nugent, C, Kanali, C., Owende, P.M.O., Nieuwenhuis, M., Ward, S., 2003. Characteristic Site Disturbance due to Harvesting and Extraction Machinery Traffic on Sensitive Forest Sites with Peat Soils, *Forest Ecology Management*;180, 85-98.
- Pereira, R.J., Zweede, J.C., Asner, G.P., 2002. Forest Canopy Damage and Recovery in Reduced Impact and Conventional Logging in Eastern Para, Brazil. *Forest Ecology and Management*. 168: 77–89.
- Spinelli, R., 1999. The Environmental Impact of Thinning: More Good Than Bad? IUFRO 3.09.00 Harvesting and Economic of Thinning. pp. 136-143.
- Unver, S. and Acar, H.H., 2009a. A Damage Prediction Model for Quantity Loss on Skidded Spruce Logs during Ground Base Skidding in North Eastern Turkey, *Croatian Journal of Forest Engineering*. 30(1):59-65.
- Unver, S. and Acar, H.H., 2009b. Evaluation of Residual Tree Damage in Sloping Areas Due to Harvesting Operations by Manually. *Austrian Journal of Forest Science*. 126(3):119-132.
- Yilmaz, M. and Akay, A.E., 2008. Stand Damage of a Selection Cutting System in an Uneven Aged Mixed Forest of Çimendagi in Kahramanmaras-Turkey. *International Journal of Natural and Engineering Sciences*. 2 (1): 77-82.

## O-08

### **The Limits and Possibilities of Japanese Swing Yarders in Comparison with European Cable Systems**

Tetsuhiko Yoshimura <sup>1,\*</sup>, Yasushi Suzuki <sup>2</sup>, Motomi Sawazaki <sup>1</sup>, Takaya Chihara <sup>3</sup> and H. Hulusi Acar <sup>4</sup>

<sup>1</sup> Faculty of Life and Environmental Science, Shimane University, 1060 Nishikawatsu-cho, Matsue, Shimane 690-8504, Japan.

<sup>2</sup> Graduate School of Integrated Arts and Sciences, Kochi University, 200 Monobe Otsu, Nankoku, Kochi 783-8502, Japan

<sup>3</sup> Shimane Prefecture Mountainous Region Research Center, 1207 Kamikijima, Iinan-cho, Iishi-gun, Shimane 690-3405, Japan.

<sup>4</sup> Faculty of Forestry, Karadeniz Technical University, Trabzon 61080, Turkey

\*Corresponding author: Tel: + 81-852-32-6511

E-mail: [t\\_yoshimura@life.shimane-u.ac.jp](mailto:t_yoshimura@life.shimane-u.ac.jp)

**Abstract:** Japanese swing yarders are typically modified from excavators and equipped with winches for cable logging. The latest statistics published by the Forestry Agency Japan shows that 950 swing yarders are introduced to Japanese forestry in the fiscal year 2014. However, their productivities are mostly low compared to European cable systems. That is because Japanese forestry does not introduce appropriate equipment such as a carriage locking device, remote controlled carriage or standing skyline that are very popular in European forestry. In addition, the two-line running skyline system, very often used for swing yarders in Japan, is almost incapable of lateral yarding for thinning especially when yarding downhill. In this study, we discussed the advantages and disadvantages of Japanese swing yarders in comparison with European cable systems, and proposed the ways to improve their productivities based on the comparative discussion.

**Keywords:** Japanese swing yarder, Excavator, Cable system

## 1. INTRODUCTION

Japanese swing yarders are typically modified from excavators and equipped with winches for cable logging (Figure 1). They are widely used in Japanese forestry as shown in the statistics published by the Forestry Agency Japan shows that 900 swing



yarders are introduced to Japanese forestry in the fiscal year 2014 (Forestry Agency Japan 2016). Japanese swing yarders are multi-purpose machines that can be used as excavators, loaders and yarders, and can be relatively easily introduced by small or medium sized forestry enterprises. In this point, Japanese swing yarders can be considered analogous to European tractors used for forestry as well as agriculture by changing attachments. Another advantage of Japanese swing yarders is their high-quality base machines that are produced by the top global construction machine companies like Komatsu or Caterpillar. However, the productivity of swing yarder logging combined with a chainsaw and processor is quite low compared to the European countries such as Austria, Germany, Switzerland and Norway probably due to the low performance of Japanese forestry machines, poor infrastructure such as forest and spur roads and inappropriate methods of harvesting trees (Yoshimura and Noba 2013). In this study, we focused Japanese swing yarders and identified their disadvantages and improvements in terms of their productivities by comparing them with European tractors.



Figure 1. A typical Japanese swing yarder.

## 2. MATERIALS AND METHODS

We investigated two European tractor-based winch systems produced by MAXWALD (Austria) and RITTER (Germany) as they may give some hints and tips to improve Japanese swing yarders. Table 1 shows the comparison of the Japanese swing yarder and European tractor-based winch systems. We also added the Syncrofalke tower yarder produced by Mayr-Melnhof (Austria) as a standard mobile yarder in Europe.

The MAXWALD winch system (Figure 2) has only basic functions without a head spar. The skyline is suspended between two standing trees. The carriage has no locking device and is not remotely controlled. It has a moving pulley that makes it possible to pull in the skidding line with double force. On the other hand, it requires a choker setter to pull out a skidding line manually with double force. The greatest advantage of using a moving pulley in uphill yarding is that the carriage does not move upward while laterally yarding by skidding line.

The Ritter winch system (Figure 3) has more advanced functions compared to the MAXWALD winch system. A remarkable difference is that the Ritter winch system uses a head spar attached to the rear of a tractor, and that skyline can be prepared faster. It also uses three lines, that is, skyline, main line and haulback line.



Figure 2. MAXWALD carriage.



Figure 3. Ritter winch system.

### 3. RESULTS AND DISCUSSION

Table 1 shows that the comparison of the Japanese swing yarder and European cable systems. The Syncrofalke tower yarder (Figure 4) has full-functions of the standard mobile yarder in Europe. Unlike the Syncrofalke tower yarder, the MAXWALD and Ritter winch systems are tractor-based, and have limited functions among those with the Syncrofalke tower yarder. The Japanese swing yarder has the least functions among four yarders compared in the table. Most commonly used Japanese swing yarders do not employ the skyline, and its carriage travels downward relatively slowly since most of them employ the two-line running skyline system. It should be also noted that intermediate supports are not compatible with the two-line running skyline system.

Table 1. Comparison of the Japanese swing yarder and European cable systems.

	Japanese swing yarder	MAXWALD	RITTER	Syncrofalke tower yarder
Skyline		✓	✓	✓
Carriage locking device				✓
Head spar			✓	✓
Number of drum	2	1 to 2	3	3
Downhill carriage travel by gravity		✓	✓	✓
Slack pulling mechanism				✓
Automatic carriage travel				✓
Remote control of carriage			✓	✓
Intermediate support		✓	✓	✓
Downhill yarding	✓	✓	✓	✓



Figure 4. Syncrofalke tower yarder

To improve the productivity of Japanese swing yarders, we believe they should be equipped with some functions with the MAXWALD and Ritter winch systems. The MAXWALD winch system uses one drum for uphill yarding while using two drums for downhill yarding. That is why we believe the MAXWALD winch system can be used with a Japanese swing yarder. On the other hand, the RITTER winch system cannot comply with Japanese swing yarders because it requires three drums.

## **REFERENCES**

- Forestry Agency (2016) *Annual report on trends in forests and forestry fiscal year 2014*, Zenrinkyou (in Japanese)
- Yoshimura, T. and Noba, T. (2013) "Productivity analysis of thinning operations using a swing yarder on steep slopes in western Japan," *Proceedings of the IUFRO UNIT 3.06 International conference, Forest Operations in Mountainous Conditions*. 35-36.

## O-09

### Developing Accessibility Measurement Tool between Forests and Woody Biomass Plants Using Google Maps API

NAKATA Chisa<sup>1</sup> and ITAYA Akemi<sup>1,\*</sup>

<sup>1</sup> Graduate School of Bioresources, Mie University, 1577 Tsu, Mie 514-8507, Japan.

\*Corresponding author: Tel: + 81-59-231-9513 E-mail: [itaya@bio.mie-u.ac.jp](mailto:itaya@bio.mie-u.ac.jp)

**Abstract:** In order to estimate harvesting and collecting costs for woody biomass plants, the accessibility measurement tool consisting Java script with Google Maps API was developed. The transportation distance and time from artificial forest points to biomass power plants were measured by JavaScript with Google Maps API. The distribution of artificial forests was obtained from the 6th vegetation survey by Biodiversity Center of Japan. As a result, the transportation distance and time for 30 points could be measured based on the current transportation network. In our system, the Euclidean distance in forests could be measured as well as roads. In the most distant forest stand, it took 4.03 hr, which distance was 150 km. The longest straight line inside of forest was 66.76 km. If straight line inside of forest were longer, additional forest road construction and logging system might be required to consider.

**Keywords:** Forest road, Harvesting, Transportation distance, Transportation time

#### 1. INTRODUCTION

It is important to consider accessibility to forests in order to sustain woody biomass supplies. The road network data has been used (Terada *et al.*, 2010) as a method to estimate accessibility as the GIS technological revolution moves ahead. However, the road network information is always changing with economic and social development. Therefore, the accessibility measurement tool has been required corresponding to the road network changes. To solve this problem, Wang *et al.* (2011) have developed the accessibility measurement tool using Google Maps API and Python. The most recent transportation routes have been able to be obtained by the tool without data expenses. Although distances of forests inside were required for considering accessibility for woody biomass supplies, Wang *et al.* (2011) did not mention that. In order to estimate harvesting and collecting costs for woody biomass plants, the accessibility measurement tool consisting Java script with Google Maps API was developed in this study.

## 2. MATERIALS AND METHODS

### 2.1 Study area and destination

Mie prefecture is located in central Japan (Figure 1), which is 577,735 ha. The forest area is 372,554 ha, and 62% of forest areas are artificial forests. The major artificial tree species are *Cryptomeria japonica* (96,170ha) and *Chamaecyparis obtuse* (103,475ha), and they occupy more than 90% of the artificial forest (Mie prefecture Agriculture, Forestry and Fisheries Department, 2014). Three biomass power plants have been installed and operated recently in Tsu city (installed in 2014, 20,000 kW, JFE ENGINEERING Corporation), Matsusaka city (installed in 2014, 5,000 kW, Matsusaka city Environment division) and Taki city (installed in 2016, 6,700 kW, Chubu Plant Service). Therefore, woody biomass supply has been a big issue in this region. The biomass power plant in Tsu was used as destination.

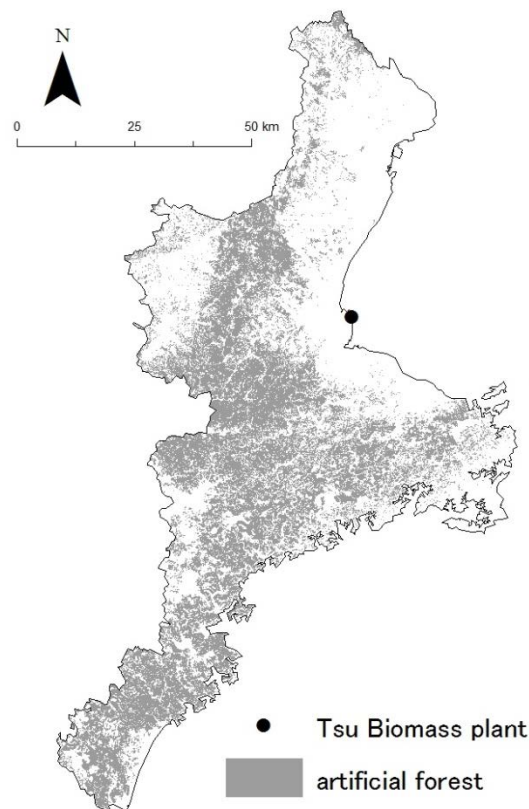

Figure 1 Study area with location of woody biomass power plants and distribution of artificial forests.

### 2.2 The distribution of artificial forest and origination

The distribution of *Cryptomeria japonica* and *Chamaecyparis obtusa* was obtained

from the 6th vegetation survey by Biodiversity Center of Japan (Ministry of the Environment). They are main artificial forest species in central Japan. These distributions were extracted as polygon data (Figure 1). The DEM (Digital Elevation Model), which was 250 m resolution, was obtained from Geospatial Information Authority of Japan. Watershed polygons were calculated using GIS (ArcGIS 10.0 / ESRI) based on the DEM. Artificial forest polygons were divided by watershed polygons, and divided forests were detected as forest stands. Latitude / longitude of centroid for each forest stand were calculated, which was 483 points. We chose 30 points from them as origination.

### 2.3 Structure of accessibility measurement tool and effectivity

JavaScript and Google Maps API have structured the developed system. By using JavaScript and Google Maps API, multiple pairings between destination and origination have been able to be processed at one time. In our developed tool, the part without the public road, which means there is no data in Google Maps, have been able to also be calculated as a straight line (Euclid distance, Figure 2). In order to leverage every tool of Google Maps, although Wang *et al.* (2011) used Python, we used JavaScript.



Google(2017)

Figure 2 Accessibility measurement by Google Maps API. Blue line were measured based on the database of Google Maps. The part of white continuous line were measured as Euclid distance.

## 3. RESULTS AND DISCUSSION

As accessibility, transportation distance and time between forest stands and a biomass power plant were measured (Figure 3 and 4). In the most distant forest stand, it took 4.03 hr, which distance was 150 km. There is a correlation between the transportation distance and time. The longest straight line inside of forest was 66.76 km. If straight line



inside of forest were longer, additional forest road construction and logging system might be required to consider. Yoshioka *et al.* (2006) estimated harvesting and collecting costs for woody biomass based on transportation distance. When we used our results, these costs might be able to extensive calculating. Although the database build-out has been progress, we have to notice that Google Maps database have an absence of forest road network in some cases.

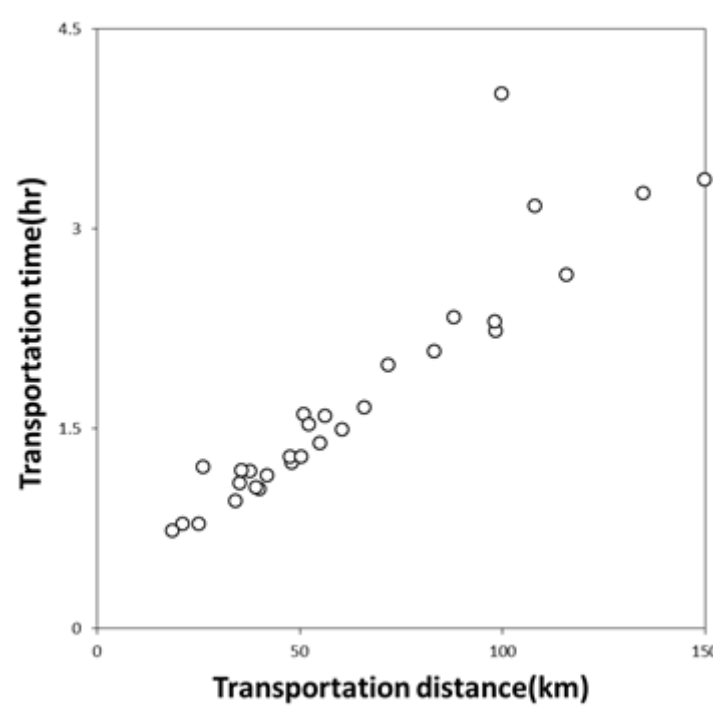

Figure 3 The transportation distance and time. Euclid distances were not included in transportation distance.

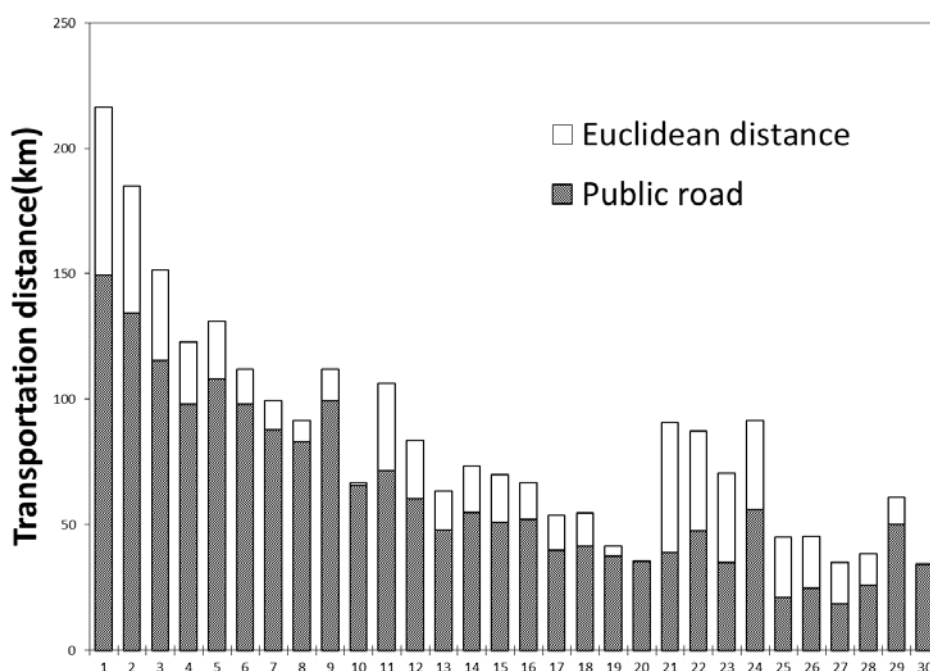

Figure 4 Euclidean distance within the transportation distance.

## ACKNOWLEDGMENTS

My deepest appreciation goes to Prof. Ishikawa and who offered continuing support and constant encouragement. I would also like to thank colleagues in the Forest engineering laboratory in Mie University who gave me invaluable comments and warm encouragements. This work was supported by JSPS KAKENHI Grant Number JP15K07479.

## REFERENCES

- Biodiversity Center of Japan, Ministry of the Environment (1999-2012). “Report of Vegetation Survey on 6-7th National Basic Survey on Natural Environment.” [online]. Available: <http://www.biodic.go.jp/trialSystem/shpddl.html>.
- Chubu Plant Service (2016) Biomass power plant Taki bio power. [online]. Available: [http://www.chubuplant.co.jp/pdf/info\\_20160628.pdf](http://www.chubuplant.co.jp/pdf/info_20160628.pdf)
- Forestry agency (2016). “Annual Report on Forest and Forestry in Japan (fiscal year 2016)”. The Ministry of Agriculture, Forestry and Fisheries of Japan, Tokyo.
- Japan wood energy Co. (2017). [online]. Available: <http://www.mori-energy.jp/hatsuden1.html>.
- JFE ENGINEERING Corporation (2014). [online]. Available: <http://www.jfe-eng.co.jp/information/list/tsu.html>.
- Matsusaka city Environment division (2014) “Matsusaka shi baiomasu katuyou

shuishinn keikaku(Matsusaka biomass utilization propotion plan)". Matsusaka city,  
Mie.

Mie Prefecture Agriculture, Forestry and Fisheries Department (2014) "Heisei 25 nendo  
ban shinrin ringyou toukeisyo(fiscal year edition forestry statistics manual)" Mie  
prefecture, Mie.

Terada.T, Yokohari. M., and Tanaka. N. (2010) "Potential of utilizing woody biomass  
from satoyama woods on plateaus assessed by the estimation of harvesting and  
collecting costs. "Japanese institute of landscape architecture73(5): 663-666

Wang.F. and Xu Y. (2011). "Estimating O-D travel time matrix by Google Maps API:  
implementation, advantages, and implications." Annals of GIS 17(No.4) : 199-209

Yoshioka.T, and Kobayashi. H.(2006) "Amount and availability of forest biomass as an  
energy resource in a mountainous region in Japan: a GIS-based analysis." Journal of  
the Japanese Forest Society Kanto branch 57:335-338.

## O-10

### Physiological Inputs in Cable Yarding Operations

Andrea R. Proto<sup>1,\*</sup> and Giuseppe Zimbalatti<sup>1</sup>

<sup>1</sup>Department of AGRARIA - *Mediterranean* University of Reggio Calabria - Feo di Vito 89122, Reggio Calabria, ITALY.

\*Corresponding author: Tel: + 39-0965-1694275 E-mail: [andrea.proto@unirc.it](mailto:andrea.proto@unirc.it)

**Abstract:** This study reports the first results of a survey on the working conditions in Mediterranean forests, where the mechanization of operations are limited owing to difficult geomorphological conditions. A sample group of forestry workers was followed. Their oxygen consumption and heartbeat rate were measured with a portable gas analyzer during five working phases to determine the physiological cost of each task. The results were used to investigate the physical stress of dynamic forestry work.

**Keywords:** Metabolic rate, Energy cost, Heartbeat frequency, VO<sub>2</sub>

#### 1. INTRODUCTION

Forestry activity is intense and physically demanding. The risks to the health and safety of forestry workers are generally characterized by a combination of natural and material risks. The natural risks are associated with steep and broken terrain, dense crops and adverse working conditions, including extremes of climate (Ozden et al., 2011). In forestry where high slopes and widespread accidented terrain limit the use of machinery, a combination of motorized and manual operations are often required for the tasks of felling, bunching, winching, etc., thus increasing the factors that lead to physical stress and risk of accidents for operators. Further risks result directly from the forestry operations themselves, both during logging and in subsequent processing tasks. Worksites are usually temporary and scattered; facilities are more difficult to arrange than at permanent work premises; climatic, topographical and biological conditions, and the large share of contractual and seasonal workers, have significant impacts on labor issues and on the welfare of workers. The estimation of the stress imposed by work is a major issue. In the case of heavy physical work, energy consumption is commonly used as the basis for classifying jobs in terms of their stressfulness (Rodahl, 1978). Energy consumption is generally determined based on oxygen consumption or heartbeat frequency during the job. Other estimation methods are based on observations (Tuure,

1992). In industry and forestry especially, the study of the physical stress of work has a long tradition (Tuure, 1992), but there are only a few outdated studies about metabolic and cardiac evaluation on forestry workers are reported in the literature (Rodio et al., 2012). Heart rate has been and is still commonly used as the criterion for the evaluation of physical demands of work but also, for example, for determining rest allowances (Rodgers 1997). Several studies have estimated the energy effort required by operators through indirect methods (Fibiger & Henderson, 1982; Kurumatani et al., 1992; Martinić et al., 2006; Aalmo et al., 2016). These are providing a valuable contribution to defining the labor capacity required for forestry operations. The aim of our study was to evaluate the physiological inputs imposed on forest workers by tasks carried out during cable yarding operations, based on direct measurements of oxygen consumption, pulmonary ventilation and heart rate. By identifying these parameters, it has been possible to determine the metabolic energy consumption required (metabolic demand) for each work phase and to evaluate aerobic capacity and heart capacity of forestry operators to verify their physical condition.

## 2. MATERIAL AND METHODS

In this study, a sample group of forestry workers was followed. Their oxygen consumption and heartbeat rate were measured with a portable gas analyzer during five working phases to determine the physiological cost of each task. The results were used to investigate the physical stress of dynamic forestry work. A total of 10 workers were monitored during five forestry work phases to estimate the physiological inputs necessary to complete a cycle of timber harvesting operations (Table 1). Workers were males between 35 and 48 years of age, a Chestnut wood (*Castanea sativa* Mill.) was used, following a reserve-cutting coppice system. A Tree-Length (TL) logging system was used in the forestry operations; after felling and delimiting, the trees were bunched with a cable yarder to the landing site and loaded into a truck. The lengths of trees ranged from 8 to 12 m and the wood volume was determined using the Smalian formula by multiplying the average cross-sectional area of the stem by stem length. The workers were told why the trial was being conducted and were advised that they could refuse to participate. They did not receive any compensation for participating and were informed that the data collected were confidential. All measurements were performed during each of the five working phases:

- *Walking to tree*. The worker, while carrying a chain saw, a fuel tank, and assorted tools, walks to reach the tree-felling site;
- *Felling*. Upon arrival at the working site, the worker starts to fell the selected trees;
- *Delimiting and Topping*. The worker removes branches and tops from a felled tree;

- *Hooking and Bunching*. After the worker has grabbed the skyline cable, he sets the choker on the tree;
- *Unhooking*. The worker unhooks the extracted trees.

Table 1. Details of the subject’s anthropometric and physiological parameters.

Parameters	Number of workers	Age (years)	Total body mass (kg)	Height (cm)	BMI (kg m <sup>-2</sup> )
<ul style="list-style-type: none"> <li>• Walking to tree</li> <li>• Felling</li> <li>• Delimiting and Topping</li> </ul>	5	42 ± 4	79.2 ± 3.2	174.6 ± 5.1	26.0 ± 1.8
<ul style="list-style-type: none"> <li>• Hooking and Bunching</li> </ul>	3	43 ± 7	80.7 ± 1.2	171.7 ± 3.1	27.4 ± 0.3
<ul style="list-style-type: none"> <li>• Unhooking</li> </ul>	2	40 ± 5	81 ± 2.8	179.5 ± 3.5	25.1 ± 0.2

### 2.1 Assessment of energy expenditure

A portable metabolic measurement system was used to quantify the energy cost of a wide range of activities. Measurements of physiological workload were carried out using a portable metabolimeter. This instrument consists of a facial mask incorporating a turbine used to measure the ventilated air volumes. A small percentage of the expired air is sent to a measurement chamber placed on the worker’s back. At the end of the trial, data were transferred on a PC for further offline analysis in the laboratory. The accuracy and reliability of the metabolimeters used have been ascertained by several studies (Meyer et al., 2005; Rodio et al., 2007). The parameters monitored were:

- Minute ventilation (V<sub>E</sub>): Amount of air moved in and out of the lungs/minute;
- Oxygen uptake (VO<sub>2</sub>): Amount of oxygen taken up and utilized by the body;
- Carbon dioxide production (VCO<sub>2</sub>): Amount of carbon dioxide generated during metabolism, primarily from aerobic cellular respiration;
- Respiratory exchange ratio (RER): Ratio between the amount of CO<sub>2</sub> produced during metabolism and O<sub>2</sub> used;
- Energy expenditure (EE): Amount of energy (or calories) that a person needs to carry out a physical function;
- Metabolic Equivalent of Task (MET): Energy cost of physical activities as a multiple of the resting metabolic rate;

- Heart Rate (HR): Number of times heart beats per minute.

### 3. RESULTS AND DISCUSSION

Each worker was requested to spend at least 45 min in each work phase with the metabolimeter switched on. All gas volumes were corrected to standard temperature and dry pressure. All data were calculated during the last 25 min of each phase to exclude transient effects on the metabolic and cardiac responses. Energy expenditure was reported as metabolic equivalent of task (MET). The overall mean values of metabolic and cardiac data in each activity are shown in Tables 2 and 3. From the analysis of the individual activities, it appears that heart strain was different in the five working phases. Pulmonary ventilation ranged between a minimum of 29.88 l min<sup>-1</sup> during the unhooking phase, to a maximum of 38 l min<sup>-1</sup> during the felling and delimiting phases. O<sub>2</sub> consumption during these phases were 0.72 l min<sup>-1</sup> and 0.94 l min<sup>-1</sup>, respectively. During the main work activities, both felling and delimiting/topping produced similar results for pulmonary ventilation and O<sub>2</sub> consumption. In these phases, peak heart rates between 136 and 109 beats min<sup>-1</sup> were recorded, achieved during short periods. The physiological cost of these activities in terms of heart rate was high. A heart rate between 125–150 beats per min reflects high physiological cost according to several studies. An average distance of 30 m and a moderate slope increased fatigue during the felling and delimiting/topping phases. Workers walked the trails from the skyline to the felled tree at slower velocity so as to not tire excessively prior to intense use of the chainsaw during felling and delimiting. Task demands can be classified according to the severity of the workload. Generally, as workload increases, HR increases (Miller 2001). The energy expenditure during unhooking and walking phases was low compared to other work activities. The caloric expenditure (MET), obtained from the consumption of O<sub>2</sub> during specific phases, was linearly related to the workload in the different phases. Comparing our data with other studies, forestry work can be classified as light to moderate with respect to the energy expenditure, heavy to optimal with respect to the HR, and intense with respect the percentage of peak. Finally, this study also confirmed a classical linear relationship between workload and HR in forestry work.

Table 2. Pulmonary ventilation data in each work phase.

<b>Work Phases</b>	<b>VE (l min<sup>-1</sup>)</b>	<b>VO<sub>2</sub> (l min<sup>-1</sup>)</b>	<b>VCO<sub>2</sub> (l min<sup>-1</sup>)</b>
<b>Walking to tree</b>	32.55 (± 7.68)	0.74 (± 0.33)	0.57 (± 0.28)
<b>Felling</b>	38.85 (± 11.98)	0.94 (± 0.41)	0.78 (± 0.42)
<b>Delimiting and Topping</b>	38.53 (± 9.78)	0.84 (± 0.39)	0.71 (± 0.37)
<b>Hooking and Bunching</b>	36.97 (± 10.28)	0.81 (± 0.51)	0.69 (± 0.49)
<b>Unhooking</b>	29.88 (± 11.92)	0.72 (± 0.35)	0.56 (± 0.30)

Table 3. Metabolic and cardiac data in each work phase.

<b>Work Phases</b>	<b>RER</b>	<b>Energy expenditure (kcal min<sup>-1</sup>)</b>	<b>MET</b>	<b>HR (beats*min<sup>-1</sup>)</b>
<b>Walking to tree</b>	0.75 (± 0.17)	3.04 (± 1.28)	3.03 (± 1.3)	82 (± 15)
<b>Felling</b>	0.81 (± 0.12)	6.10 (± 2.95)	3.76 (± 1.6)	136 (± 28)
<b>Delimiting and Topping</b>	0.79 (± 0.15)	5.71 (± 2.06)	3.68 (± 1.4)	109 (± 19)
<b>Hooking and Bunching</b>	0.81 (± 0.16)	5.62 (± 1.59)	3.71 (± 2.1)	101 (± 12)
<b>Unhooking</b>	0.71 (± 0.16)	2.85 (± 1.33)	2.97 (± 1.4)	76 (± 16)

#### 4. CONCLUSIONS

Our study confirmed that hooking and bunching are two very heavy tasks in forestry work. Other studies identified similar tasks to high level of physical stress ( Aalmo et al. 2016). The assessment of the extent of physical stress and ergonomic improvements of the various jobs in forestry can greatly benefit from precise measurements of the



physical stress of the tasks involved (Tuure, 1992). The possibility to collect HR data from a working subject with minimal personal discomfort or disruption from his normal work routine ensures the collection of accurate and relevant information. Data interpretation can be used to support decision making or job planning, to better engage workers in specific tasks and to prevent or mitigate any adverse effect on the worker's health and safety (Rodio et al., 2012). Investing in occupational safety and health provides improved working conditions, higher productivity, and healthier labor relations. In turn, working conditions in forestry operations can be significantly improved in a viable and cost-effective way through safety and health measures (ILO, 2000). This first methodological approach, beyond some limits due to different factors (*number of examined samples, analysis of medical analysis, evaluation of recovery times*), could be useful as clinical data become available for workers exposed to different forestry tasks and will be considered a first step for this type of methodological approach.

## ACKNOWLEDGEMENTS

This study is a part of the Project "ALForLab" (PON03PE\_00024\_1) co-funded by the National Operational Programme for Research and Competitiveness (PON R&C) 2007-2013, through the European Regional Development Fund (ERDF) and national resource (Revolving Fund -Cohesion Action Plan (CAP) MIUR).

## REFERENCES

- Afolabi, B.O. and Akanbi, O.G. (2013) "Effects of body mass index on aerobic power (VO<sub>2</sub> max) and energy expenditure (EE): A case of manual load lifting in agro-processing" *IJSER* 4(5): 1718–1721.
- Åstrand P.O. and Rodahl, K. (1986) *Textbook of Work Physiology - Physiological Bases of Exercise*. (3rd ed.). Mc-Graw-Hill, New York.
- Aalmo Ottaviani G., Magagnotti N. and Spinelli R. (2016) "Forest Workers and Steep Terrain Winching: the Impact of Environmental and Anthropometric Parameters on Performance". *Croat. j. for. eng.* 37
- Fibiger, W. and Henderson, M. (1982) "Physiological inputs to motor-manual techniques of thinning radiata pine". *New Zealand Journal of Forestry Science* 12(2), 162–170.
- Kurumatani, N., Yamaguchi, B., Dejima, M., Enomoto, Y., and Moriyama, T. (1992) "Applied Physiology and physical demands of forestry operations". *European Journal of Applied Physiology*, 546–551.
- Martinić, I., Šegotić, K., Risović, S., and Goglia, V. (2006) "The effect of body mass on physiological indicators in the performance of forestry workers". *Collegium*

- Antropologicum*, 30(2), 305–311.
- ILO (2000) *Approaches to Labour Inspection in Forestry – Problems and Solutions*. Sectoral Activities Department, ILO, Geneva.
- Meyer T., Davison R.C. and Kindermann W. (2005) “Ambulatory gas exchanges measurement—current status and future options”. *Int. J. Sports Med.* 26:19-27.
- Miller, S. (2001) *Workload Measures Document id: N01-006*, National Advanced driving Simulator, The University of IOWA, 65 p.
- Ozden, S., Nayr, I., Gol, C., Eds, S., and Ylmaz, H. (2011) “*Health problems and conditions of the forestry workers in Turkey*” 6 (Forest Economics Department, Faculty of Forestry, Cankr Karatekin University, Cankr, Turkey.), 5884–5890.
- Park, H., Lee, J., Choi, Y., and Kim, M. (2003) “Evaluation of work intensity by moving work in forest”. *J Korean For Soc*, 92
- Parker, R., and Kirk, P. (1994) *Physiological workload of forest work*. LIRO Report (New Zealand Logging Industry Research Organisation) 19(4): 1–49.
- Rodahl, K. 1978. *On the assessment of physical work stress*. In: G. Borg (Ed.), *Physical work and effort*. Proceedings of the first international symposium held in December 2-4 1975. Oxford. pp. 199-216.
- Rodgers, S. (1997) *Work physiology–fatigue and recovery*. Handbook of human factors and ergonomics. 2<sup>nd</sup> ed. JohnWiley and Sons, New York, 268–298.
- Rodio, A., Fattorini, L., Delussu, A. S., Marchetti, E., Marchetti, M., and Rosponi, A. (2012) “Forestry work in the Italians Alps: metabolic demand assessed by heart rate”. *Italian Journal of Public Health*, 4(2).
- Staal Wästerlund, D. (2001) “*Heat stress in forestry work*” *Acta Universitatis Agriculturae Sueciae, Silvestria* 213: 1401–6230.
- Trites, D.G., (1992) *Ergonomics of tree planting work among British Columbia forest workers*. Theses Simon Fraser University, 96 p.
- Tuure, V. (1992) “*Determination of physical stress in agricultural work*”. *International Journal of Industrial Ergonomics*, 10 (1992) 275-284 Elsevier

## O-11

### **Risk Perception and Work Safety Behavior of Indonesian Chainsaw Operators**

Efi Yuliati Yovi<sup>1</sup>

<sup>1</sup> Faculty of Forestry, Bogor Agricultural University, Indonesia

Campus IPB Dramaga, Bogor, West Java, Indonesia 16680.

Email: [eyyovi@apps.ipb.ac.id](mailto:eyyovi@apps.ipb.ac.id)

**Abstract:** Operating a chainsaw in forest harvesting operating is well associated with high occupational health disturbances and accidents risk. Adopting psychometric paradigm, this study tried to grab risk perception of the Indonesian chainsaw operators. As much as 40 activities (covered chainsaw maintenance up to felling techniques) were questioned to 25 chainsaw operators. The results show that in average, the operators considered them self as having good safety practice in their daily work activity, while improper work behaviors and lifestyle were still being practiced. This study also shows improper perception toward risk elements. The ignorant of the hazards sources, risks, and risk level are obvious. If there is an accident, they noted that the consequences are relatively fatal, more to be an individual than to mass effect, but they object to accept the impact to their safety and health. They also think that they, somehow, able to avoid the risk that may occur. Although this is an initial study, in general in can be stated that clear, but simple and understandable information related to the hazards sources, risks, risk level, accident process, and its prevention should be provided and can be accessed easily.

**Keywords:** Occupational health, Risk perception, Tree felling, Psychometric paradigm

#### **1. INTRODUCTION**

Forest operation which consisted of felling, skidding, and log transporting is considered as activities with a heavy workload and high risk caused by accident and health disturbance to the workers (Wang *et al*, 2003; Yovi *et al*, 2006). Even tough, mechanization is massively adopted in many well-developed countries, accident rate and severity rate that indicate this high-risk level is still reported by many studies. Chainsaw is the most known machine to be used in felling activities. Chainsaw is well-known for its handy and comfortable control to perform cutting on felling, trimming, delimiting, topping, and bucking on many tree cylindrical shapes, health

conditions, and its leaning directions.

However, chainsaw should also be considered as the main hazards sources in tree felling activity. Many reports of studies, from well-developed countries to less developed country with low technology application in felling activity, has revealed this fact (Peters 1991). Indonesia is a country that also widely uses chainsaw in felling operation. Even though recently the country shows an aggressive development in fast growing species plantation forest which deal with small diameter of tree (average: 16-20 cm), and the use of tree harvesters or feller bunchers has become a trend in these forests, however, due to the reason of lower production cost and providing employment opportunities (as an embodiment of social responsibility), chainsaw still plays an important role in supporting the felling activity.

There is no official data that can be used to refer the accidents rate occurred due to chainsaw operating. However, some studies show the improper use of chainsaw in this country. Improper maintenance, lack of knowledge and unskillful chainsaw operator, and worse by low company regulation on chainsaw safety operation is among the major problems observed (Yovi and Yamada, 2015; Yovi *et al*, 2016).

Considering that occupational safety is not merely a must to fulfill any regulations and to meet economics reason, as more than that, occupational safety is a human right, this study was designed to support higher occupational safety practice by focusing on the aspect of risk perception of the chainsaw operators when operating chainsaw. Risk perception is a subjective assessment that goes beyond the individual constructing their social and cultural beliefs (Weinstein, 1980). The most common approach to capture the perceived risk is psychometric paradigm (Fischhoff *et al*, 1978). Brewer *et al*. (2007) showed that risk perception is significant variables that can be used to predict prevention behaviors. In the same line, several kinds of research had proved that there is a positive link between risk perception and safety protective behavior (Ji *et al*, 2011). The term of “risk” in this study follow the definition stated by Rayner and Cantor (1987): “the probability of an expected event and the magnitude of its consequences, which meets with the engineering-type calculation of risk.”

## **2. METHOD**

This study was carried out in 5 forest enterprises having similar forest and forest operation type involved as much as 25 chainsaw operators. As much as 9 risk perception elements representing risk characteristics were questioned on the 1-7 scale. These elements were chosen based on the work of Fischhoff *et al* (1978), which consists of (1) voluntary level in facing the risk, (2) immediacy of effect, (3) the level of recognizing toward the risk from the point of view of the victim (those exposed to the

risk), (4) potential scale of the risk in killing people (chronic or catastrophic), (5) gut reaction towards the risk, (6) severity of the consequences, (7) understanding regarding to the risk level, (8) level of control in the term of personal skill, and (9) the newness of the risk.

Aspects related to felling technique, chainsaw maintenance, personal protective equipment, tool aids, the source of hazards, operating, and lifestyle were questioned (40 questions). The respondents also were interviewed to grab a scale of their subjective assessment of their actual work behavior. In the same time, we also asked their opinion several improper work behavior related with felling. Therefore, in total, one respondent should answer as much as 440 items.

### **3. RESULTS AND DISCUSSION**

Average of the result (2.8 out of 7 scales) shows that the respondents consider them self as having good safety practice in their daily work activity. However, in contrary, improper work behaviors were still being practiced.

In the term of lifestyle, they scaled them self as a heavy smoker (more than 10 cigarettes per day), ignoring to take care about their food consumption -no attention to the nutritional value- and their lifestyle is worsened by inadequate night sleep.

In the term of personal protective equipment, they stated that they often work without wearing helmet, visor, earmuff/ear plug, safety cap, and safety shoes. In term of chainsaw operative, most of them does not put the blade cover (scabbards) when carrying the chainsaw walk to other trees and only perform maintenance when there problems with their chainsaw. In term of felling technique, fell the supporting tree in an attempt to free the hung-up tree is considered as a common practice. A further interview revealed that they considered this is the best technique in handling a hung-up tree. And, in term of chainsaw maintenance, they use spare parts that may not be the parts required by the chainsaw maker.

The result of the nine risk characteristic is shown in Figure 1 which set a position of each character among the 1-7 scale. Scale 1 for voluntariness means the respondent feel that they were not being forced to accept any of risk may arise from the activity. Scale 7 means they totally being imposed to accept the risk. The smaller scale points to a “risk perception attenuation direction”, and in contrary, the bigger scale point to a “risk perception amplifying direction”. The direction of the scale is similar to the potential number of killed people if accident happened (chronics-catastrophic), how an individual think about living with such a risk (common-dread), individual perception toward severity of any consequence emerged from the risk (not fatal-fatal), and the newness of the risk (new-old).

However, different interpretation should be underlined when discussion the rest 4 characters. In contrary with the first 5 characters, the bigger point in these last 4 characters point to “risk perception attenuation” and the smaller point indicates the stronger amplifying effect may arise from the character. These 4 risk characteristics consists of immediacy of the death effect (immediate-delayed), the known level of people exposed to the risk concerning the actual loss (known to the exposed not - known to the exposed), the known level of the risk level (known to science-not known to science), and the last is level of control toward risk may arise (uncontrollable-controllable). People became more ignorant to the risk if the effect of death is delayed, they have no adequate knowledge on the actual loss they may suffer, they have no knowledge on the risk level, and, this is the most common phenomena, people become more ignorant to the risk if they think that they can control the risk (Slovic, 1997).

Figure 1 shows that in general, the respondents feel that the risk they have to face is a burden, they actually do not want to face the risk. And they actually understand that the risk may bring a deep severity (fatal consequences). They already know about the risk for at least 3 years before. In regard the scale of loss party, they stated that the losing party will be limited to directly involved individual only.

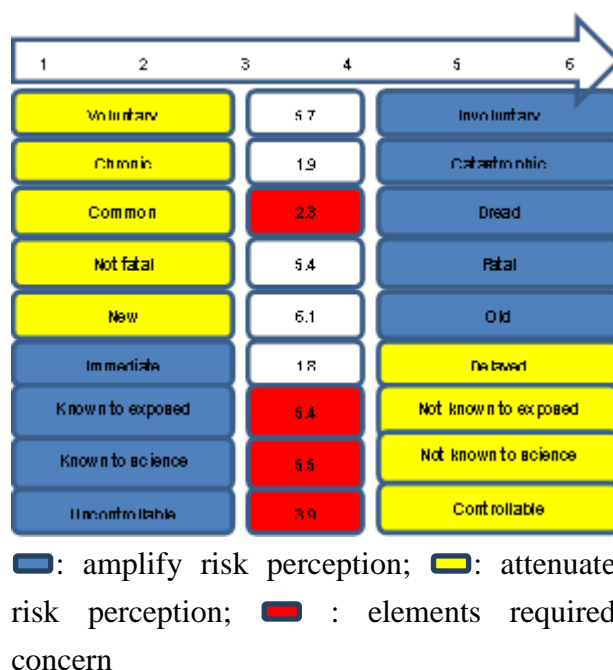

Figure 1 Qualitative characteristics of perceived risk for felling activity by using chainsaw

However, it is a disappointment to know that most of the respondents consider the risk may arise when working with a chainsaw is a something that they have learned to live with. It is also a finding that most of the people that experienced to be exposed to the risk were actually have no idea the actual loss they suffered. They did not think that the loss will be that serious. In the same line, they also have no good knowledge to explain the risk level they may suffer due to the risk. Their knowledge is limited on immediate effect only; meanwhile, a chainsaw may cause health disturbances after a long term contact, for example, hearing ability disturbance, etc. And, the worst is that they still think confidently that they able to control any risk may arise.

The findings above lead to important points that should be used a basis for designing strategies in increasing the occupational safety and health protection to these chainsaw operators. The first, they should have better information related to the hazard identification, risks, and risk level. For example, hearing loss which often being ignored by the chainsaw operators due to “delayed” effect. It takes a relatively long period (could be years) before the irreversible damage occurred. The impact of hearing loss will affect the quality of life of someone (Concha-Barrientos *et al*, 2004) is also should be informed. A wide spectrum of example should be given, so in will increase familiarity with the risk. This way, the risk is more known to science or the affected person, therefore the risk is perceived better.

The second, in order make the significant effect of the information, total loss due to the accident or health disturbances, or disruption to the production process should be “translated” into the most tangible unit (de Weerd *et al*, 2014). People have a better perception of risk if the loss is illustrated in the term of how much money involved. The information on this also should be provided in a very clear and easy to understand sentences, considering the educational background of most operators.

The third, they should have a good understanding that most of the risk while working with a chainsaw is preventable. And the preventions are mostly no cost at all. And they should get information that ability to control does not always in line with the ability to control the risk. A study by Sjöberg (2000) on socio-psychology mention that people tend to overestimate their ability to control a situation and this fact attenuate the perceived risk.

And the fourth, information on how a risk transformed into accident and cause injured or health problem should be provided and can be accessed easily. The information should cover that the driver of this transformation could be something that is very simple, thoughtless, or silly, and it may take a very short period, even less than a second, but causing big and sometimes permanent damages.

## REFERENCES

Brewer, N.T., Chapman, G.B., Gibbons, F.X., Gerrard, M., McCaul, K.D., Weinstein, N.D.

- (2007) “Meta-Analysis of the Relationship Between Risk Perception and Health Behavior: The Example of Vaccination.” *Health Psychology*, 26(2): 136–145.
- Concha-Barrientos, M., Campbell-Lendrum, D., Steenland, K. (2004) “Occupational noise: Assessing the burden of disease from work-related hearing impairment at national and local levels.” *Environmental Burden of Disease Series*, 9. WHO: Geneva.
- de Weerd, M., Tierney, R., van Duuren-Stuurman, B., Bertranou, E. (2014) “Estimating the cost of accidents and ill-health at work: A review of methodologies.” Luxembourg: European Agency for Safety and Health at Work.
- Fischhoff, B. *et al.* (1978) “How safe is safe enough? A psychometric study of attitudes toward technological risks and benefits.” *Policy Sciences*, 9(2), 127-152.
- Ji, M., You, X., Lan, J., Yang, S. (2011) “The impact of risk tolerance, risk perception and hazardous attitude on safety operation among airline pilots in China.” *Safety Science*, 49, 1412-1420. <http://dx.doi.org/10.1016/j.ssci.2011.06.007>.
- Peters, P.A. (1991) “Chainsaw felling fatal accidents.” *Transactions of the American Society of Agricultural Engineers*, 34, 2600–2608.
- Rayner, S., Cantor, R. (1987). How fair is safe enough? The cultural approach to societal technology choice. *Risk Analysis*, 7, 3-9.
- Sjöberg, L. (2000) “Factors in risk perception.” *Risk Analysis*, 20(1), 1-11.
- Slovic, P. (1997) “Trust, emotion, sex, politics, and science: Surveying the risk-assessment battlefield.” In: Bazerman, M.H. *et al* (eds.). *Environment, ethics, and behavior*. San Francisco: New Lexington, 277-313.
- Wang, J., Bell, J.L., Grushecky, S.T. (2003) “Logging injuries for a 10-year period in Jilin Province of the People’s Republic of China.” *Journal of Safety Research*, 34, 273–279.
- Weinstein, N.D. (1980) Unrealistic optimism about future life events. *J. Pers. Soc. Psychol.*, 39(5), 806-820.
- Yovi, E.Y., Takimoto, Y., Ichihara, K., Matsubara, C. (2006) “A study of workload and work efficiency in timber harvesting by using chainsaw in pine plantation forest in Java Island (2): thinning operation.” *Applied Forest Science*, 15(1), 23-31.
- Yovi, E.Y., Yamada, Y. (2015) “Strategy to disseminate occupational safety and health information to forestry workers: The felling safety game.” *Journal of Tropical Forest Science*, 27(2), 213–221.
- Yovi, E.Y., Yamada, Y., Zaini, M.F., Kusumadewi, C.A.Y., Marisiana, L. (2016) “Improving the OSH knowledge of Indonesian forestry workers by using safety game application: tree felling supervisors and operators. *J. Man. Hut. Trop.*, 22(1), 75–85. <http://dx.doi.org/10.7226/jtfm.22.1.75>.



## O-12

### **Analysis of work-related injuries of felling work using chain saws in Japan**

Kyoko Tobita and Toshio Nitami<sup>1,\*</sup>

<sup>1</sup> Graduate school of Agricultural and Life Science, The University of Tokyo, 1-1-1, Yayoi, Bunkyo-ku, Tokyo 113-8657, Japan.

\*Corresponding author: Tel: +81-3-5841-5205

E-mail: [kyoko.tobita@j-luonnonlapsi.com](mailto:kyoko.tobita@j-luonnonlapsi.com)

**Abstract:** We can find the highest occurrence probability of fatal accidents at forestry among industries. Accidents during felling work exceed 60-70% among them. Existing analyses of work-related injuries have classified them by work contents and tools due to the accident so far. This study is to intend to consider instruction items which is required in the education of the chain saw works. I investigated the tendency of the date, time and day of the week that an accident occurred. I also divided the cause of the accident dividing factors into two categories, they were caused by poor felling technique and ability for safety management of its work environment. The study was based on the data which refers to “fatal accident database” compiled by Ministry of Health, Laborer and Welfare and “forestry fatal accident breaking news” compiled by Forestry and Timber Manufacturing Safety & Health Association.

**Keywords:** Chain saw, Work-related injury, Felling

#### **1. INTRODUCTION**

Among all of industries, the most of fatal accidents occurs in forestry. Rate of accidents during felling works exceeds from 60 to 70% (Forestry and Timber Manufacturing Safety & Health Association, 2017). Because the forest topography is steep, most felling work are done with chainsaw. It is inferred that in order to reduce fatal accidents, we need technical education as well as safety management activities. However, with current methods of analysis, it is difficult to find relationship between education and accidents. Therefore, in this study I wanted to focus on relationship between education and fatal accidents by analyzing factors and trend of accidents during felling works.

## **2. METHODS**

In this study, I analyze fatal accident during felling work with following items.

1.prefecture 2.volume of production 3.month 4.day of week 5.hour

The items from 1 to 4 are analyzed with the data released by Forestry and Timber Manufacturing Safety & Health Association from 2000 to 2014 (Forestry and Timber Manufacturing Safety & Health Association, 2017). The analysis objects of accidents described as “tree felling” ”tree cutting” ”treatment of wind-fall trees” and “treatment of snow damage trees” as items of work type. The item 5 is analyzed with the data released by Ministry of Health, Labour and Welfare from 2000 to 2014 (Ministry of Health, Labour and Welfare, 2017). The analyzed objects of accident, described as “major classification: agriculture and forestry (code 6)” “medium classification: forestry (code 602)” “small classification: timber harvesting (code 60201)”, attributable item as “major classification: environment etc. (code 7)” “medium classification: natural environment etc. (code 71)” “small classification: tree etc. (code 712)” as type of industry. Furthermore, the factor of fatal accidents are basing on the data released by Forestry and Timber Manufacturing Safety & Health Association from 2000 to 2014, and extracting action and phenomenon that are considered to be factor of fatal accident extracted from accident occurrence situation.

## **3. RESULTS**

The number of fatal accidents during felling work from 2000 to 2014 year is 391 which gives 57% of whole fatal accidents data by Forestry and Timber Manufacturing Safety & Health Association. While, data by Ministry of Health, Labour and Welfare show 337cases and 47% of whole fatal accidents. Figure1 shows volume of production by prefecture and number of fatal accidents during felling work from 2000 to 2014. 1.4 accidents have occurred per million cubic meters. Figure2 shows correlation coefficient of these data. It is 0.8492. That data shows that volume of production and Number of fatal accidents during felling work are strongly correlated.

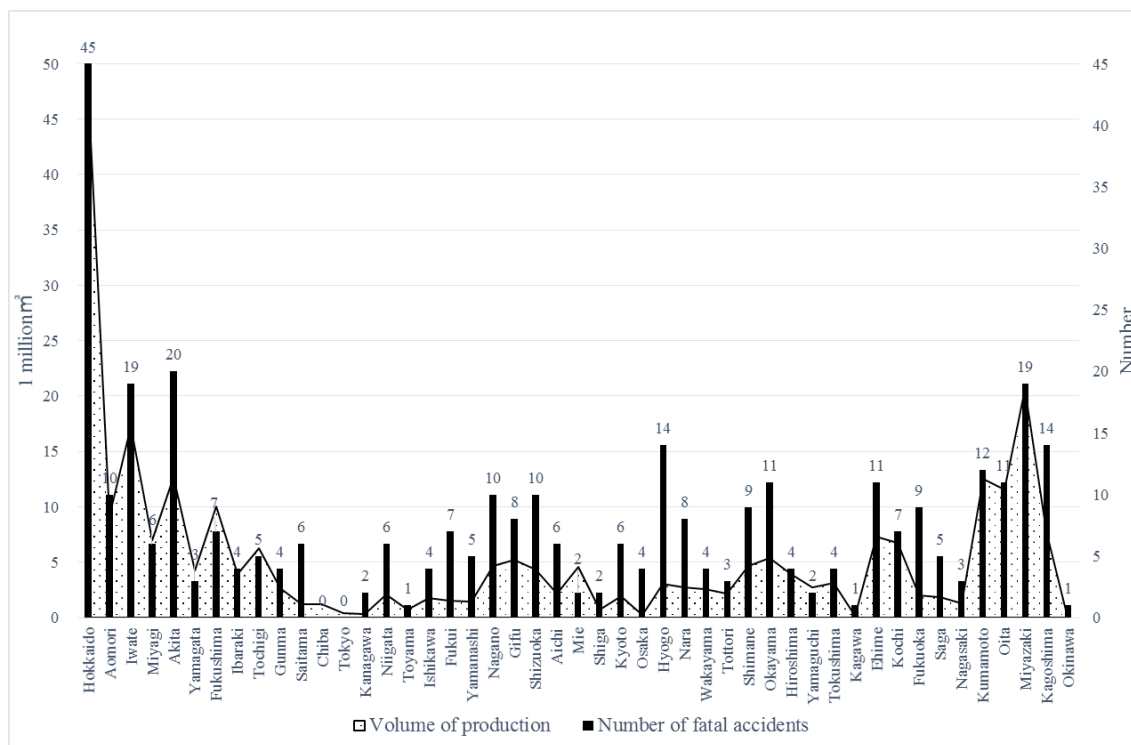

Figure 1. Volume of production by prefecture and Number of accumulation of fatal accident during felling work (2000~2014)

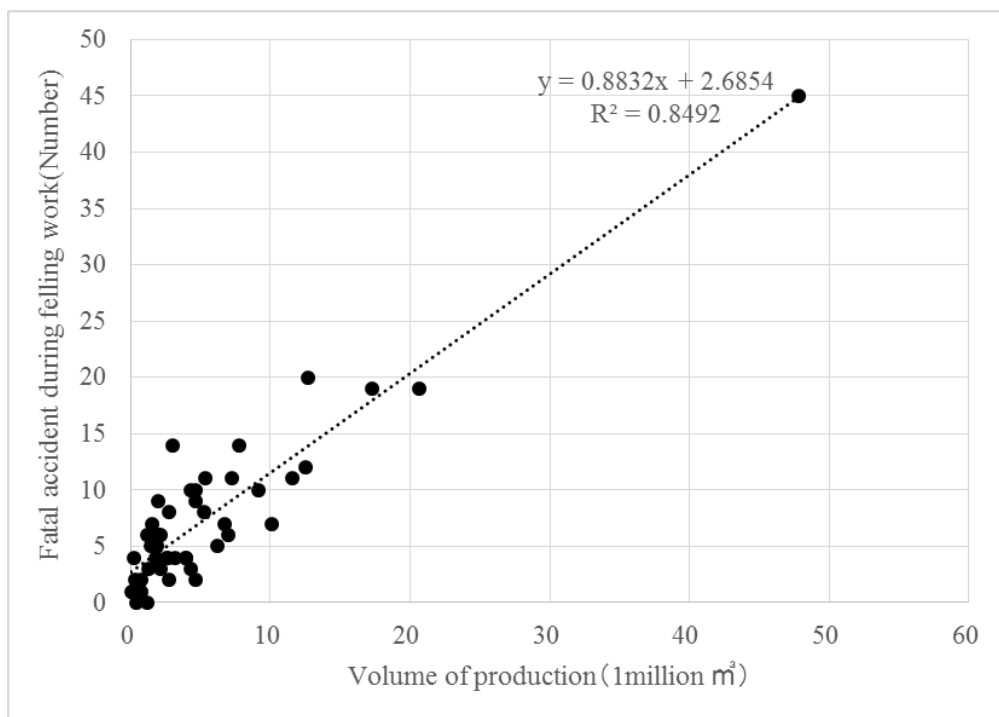

Figure 2. Scatter diagram by volume of production and Number of fatal accident during felling work (2000~2014)

Figure3 shows monthly trend of fatal accidents during felling work. Also figure4 shows day of week trend data and figure5 shows hourly trend data. Day of week trend shows many accidents occur on Friday.

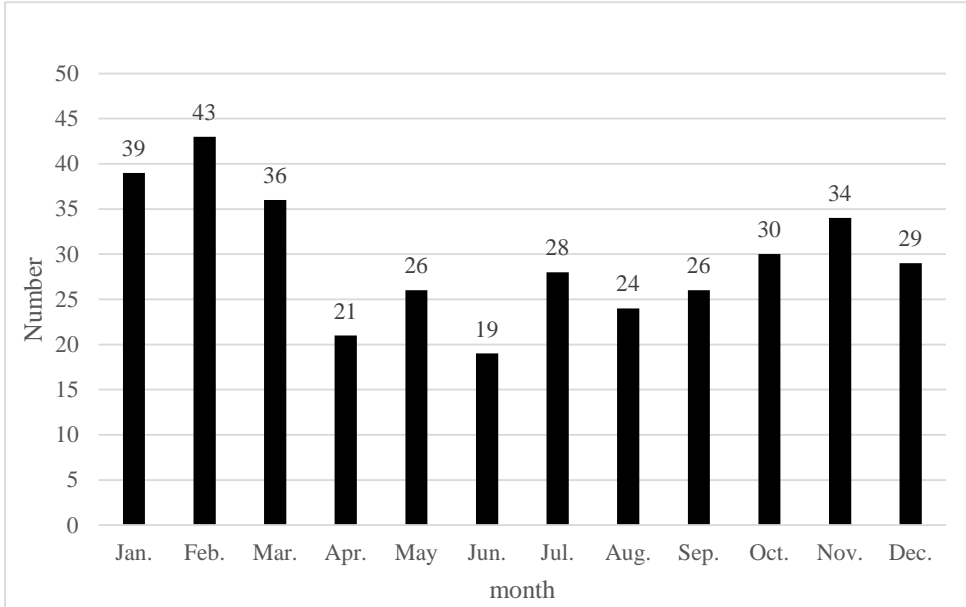

Figure 3. Monthly trend of fatal accident during felling work

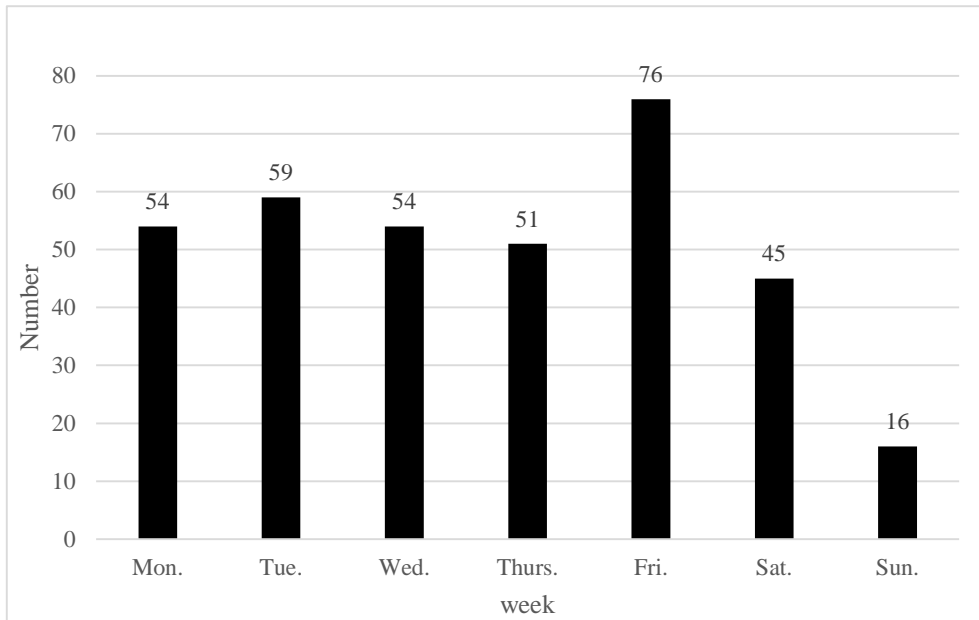

Figure 4. Day of week trend of fatal accident during felling work

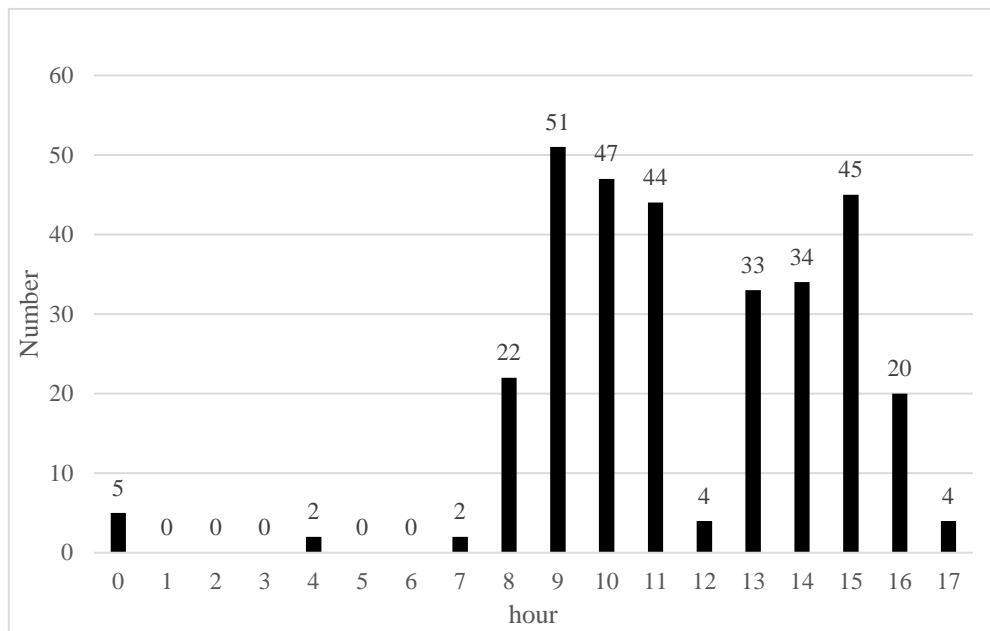

Figure 5. Hourly trend of fatal accident during felling work

Factor of fatal accident during felling work extracted from accident occurrence situation is summarized in Table 1. As a result, the number of items are 14. Figure 6 shows number of factor of each fatal accident during felling work. Factor of fatal accident is not necessarily one for one case. In some cases number of factors can even reach 5. Only 25% of the total accidents are caused by one factor, 75% is a fatal accidents occurred by multiple causes overlapping (Fig.7).

Table1. Factor of fatal accident during felling work

FACTOR	DEFINITION
1 Mistake escape	The accident related to mistakes in judgment the escape place and the escape delay of the person who felling work
2 Touch with around trees	The accident related to the fact that logging tree are in contact with surrounding trees during lodging.
3 Change of felling direction	The accident related to that a logging tree to the direction not to aim at for any causes
4 Hung up trees	The accident related to hung up tree
5 Vine coiled tree	The accident related to vine coiled tree
6 Short escape distance	The accident related to entry into dangerous areas centering on logging tree and standing danger of lodging
7 Unstable foothold	The accident related to carelessness during felling work
8 Tree fall start suddenly	The accident related to sudden start of lodging.
9 Sliding down	The accident related to sliding down
10 Tree split	The accident related to tree split
11 Carelessness upper side	The accident related to falling objects (such as branches and upper parts of fallen trees)
12 Leave the hung-up tree	The accident related to hung up tree which was left
13 Leave the tree in the middle of work	The accident related to logging tree which was left in middle of lodging
14 Tree bounces, Tree breaking	The accident related to tree bounces and tree breaking.

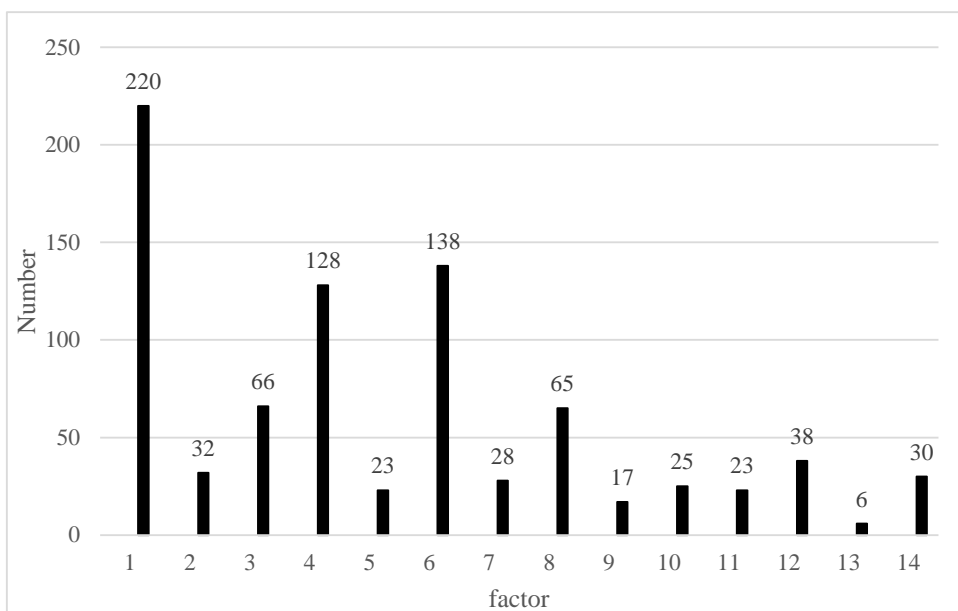

Figure 6. Number of factor of fatal accident during felling work

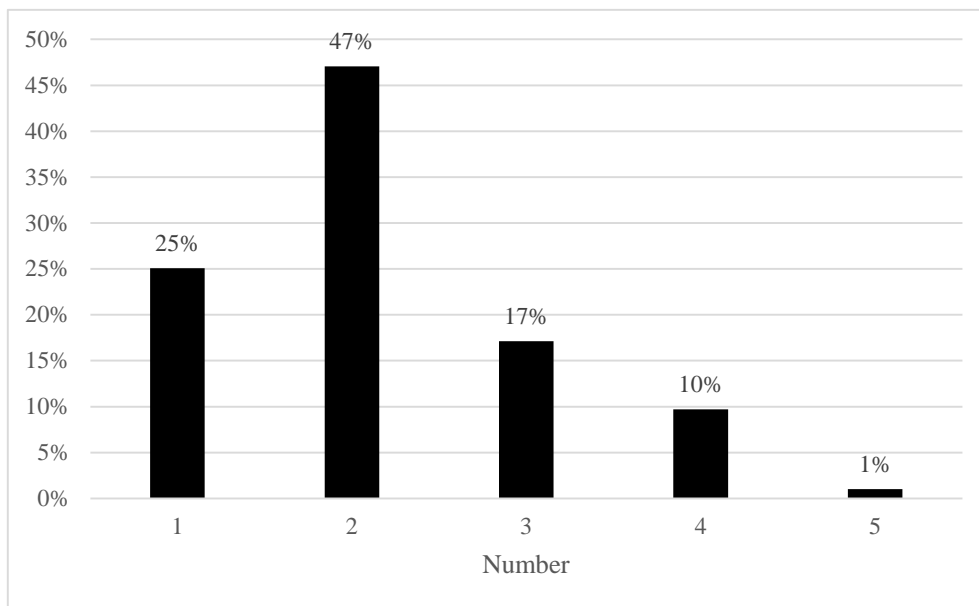

Figure 7. Factors ratio per fatal accident

#### 4. DISCUSSION

Volume of production and Number of fatal accident during felling work are strongly correlated. There is a strong relation between amount of work which needs to be done and number of accidents. According to day of week trend of fatal accidents during felling work, it is presumed that accumulated fatigue and carelessness are related to occurrence of accident. Therefore, it is presumed that safety and technical education needs to consider the case of lowering concentration during works. Factor of fatal accident No.2.3.4.10.14 can be prevented by correctly performing Felling cut, Notch and Hinge (Uemura, Okayasu, Inoue, Kariya, Oka and Kashima,2015) (Uemura, 2015). As well as using mock-ups in practice areas in order to increase skills for safety (Tottori Austria forestry inspection, investigating group, 2016). Therefore, the accident caused by No.2.3.4.10.14 can be expected to decrease fatal accidents by creating education techniques such as Felling cut, Notch and Hinge. Consequently, it is presumed that in order to reduce accidents, we need well technical education as well as safety management activities.

#### REFERENCES

- Forestry and Timber Manufacturing Safety & Health Association(2017.1.15) , Change of the situation of the death disaster by the difference in work in the forestry (2006~2015) , *Web of Forestry and Timber Manufacturing Safety & Health Association*, <http://www.rinsaibou.or.jp/index.html>
- Forestry and Timber Manufacturing Safety & Health Association (2017.1.15),

- Work-related accident in the forestry (death disaster) list of breaking news, *Web of Forestry and Timber Manufacturing Safety & Health Association*, <http://www.rinsaibou.or.jp/index.html>
- Ministry of Health, Labour and Welfare (2017.1.15), database of death disaster, *Web of Ministry of Health, Labour and Welfare*, [http://anzeninfo.mhlw.go.jp/anzen\\_pg/SIB\\_FND.aspx](http://anzeninfo.mhlw.go.jp/anzen_pg/SIB_FND.aspx)
- Takumi UEMURA, Takashi OKAYASU, Eiji INOUE, Yoshihiro KARIYA, Masaru OKA and Jun KASHIMA(2015) : The effect of “bypass notch” and “uneven hinge thickness” on directional felling and job safety. *J. Jpn. For. Eng. Soc.* 25(4):207~214.
- Takumi UEMURA(2015): Transition and problems of felling techniques in Japan(<SPECIAL ISSUE>Tools and machines for logging) *J. Jpn. For. Eng. Soc.* 30(1) : 5-10
- Tottori Austria forestry inspection, investigating group(2016), *Tottori Austria inspection, working papers (A forestry growth industry investigates a key to becoming it)*, Tottori prefecture.



## O-13

### ICT Assistance and Management for Manual Chainsaw Operation

Toshio NITAMI<sup>1</sup>, Ph.D., and Sooil SUK<sup>2</sup>, Ph.D.

<sup>1</sup> University of Tokyo, JAPAN

<sup>2</sup> Tokimek-Korea, KOREA

**Abstract:** Chainsaw operation by manual work is inevitable for forestry operation. The portable device is connected to the human body movements to maneuver the chainsaw for felling, delimiting, crosscutting and so on. These actions can be interpreted into the productivity and are utilized to grasp how these processes. The former is essential for operation system management and the latter enables work safety management. ICT enabled sensors on the chainsaw to see the posture, movements, vibration and the mechanical movements. This provides understanding on the usage condition and the process transition/continuity, they show the operation processes. A chainsaw with these sensors was developed and the process understanding model was developed. Also a set of the utilization and the further utility for regional/national/grovel management and control on the handheld machineries were discussed.

**Keywords:** Chainsaw, Manual work, Safety, Productivity, ICT

#### 1. PREFACE

All countries on forestry have been suffering from frequent accidents at manual chainsaw operations. Even in the countries where have vehicle based sophisticated forestry operation much consideration were paid for manual works.

When we look on a local forestry related activity an integrated business framework would be constructed as on figure 1, and each field operations are connected to the database for central controlling function unit to upload their operation data for keeping it fresh.

The smart chainsaw is one of these machineries in the field but which is close to human activity. By sensors multi data are obtained on the condition of the human operation. The data can be utilized for productivity management and safety management.

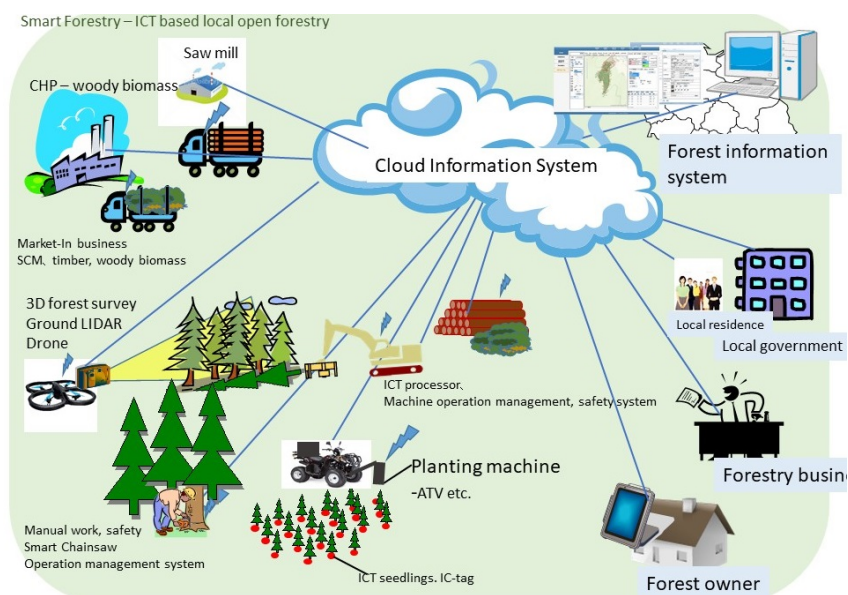

Figure 1. Image illustration on a local forestry supply management system.

## 2. DEFINITION, FUNCTION AND UTILIZATION OF SMART CHAINSAW

Motion and maneuver sensor equipped chainsaw together with data process, evaluation, understand and communication function/system is named Smart Chainsaw, as on figure 2, Patent pending, P2016-78265A. Extensionally, operation advice, alert and report functions are included.



Figure 2. Smart chainsaw operation and the image illustration for the posture and felling direction.

## 3. MECHANISM AND ACQUIRING DATA

A smart chainsaw is equipped with a 3D acceleration sensor, a 3D rotation speed sensor, a 3D magnetic direction sensor, as on figure 3, and throttle trigger reader, an engine revolution detector, a saw chain running speed and a GPS. Each sensor provide data at independent frequency fit for analysis, as shown on Figure 4.



Figure 3. Smart chainsaw and 3D coordinates.

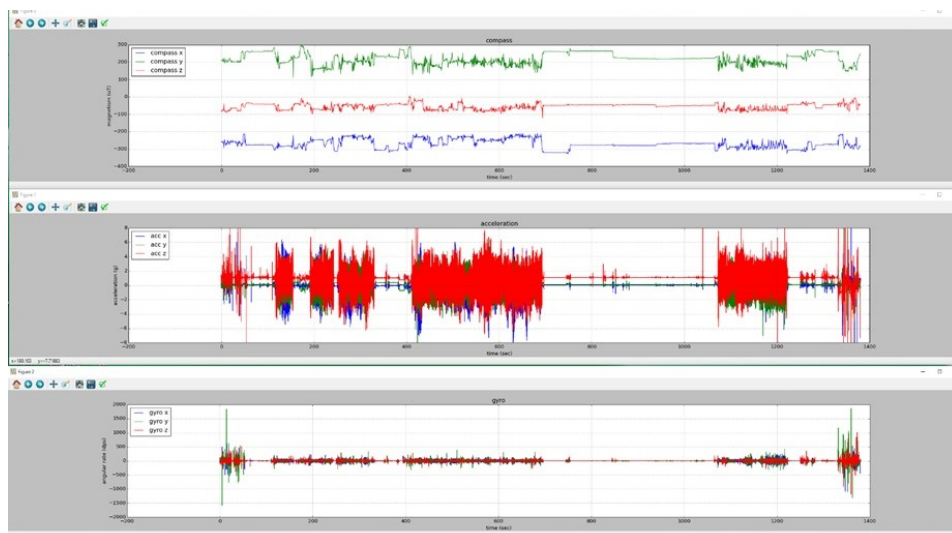

Figure 4. 3D chainsaw data.

Magnetic dir., acceleration, rotation speed.

#### 4. DATA ANALYSIS AND WORK PROCESS UNDERSTANDING

Obtained data set is processed through the model based on transition probability, Figure 5. We can find the status change watching through a time wind. AI method is certainly useful to be applied for this process and hopefully can make the process simple and rapid.

$$A \\ A^n \rightarrow \tilde{A}$$

Figure 5. When the transition probability is fixed, a stable matrix can be obtained.

Here we can have dynamically deviate matrix.

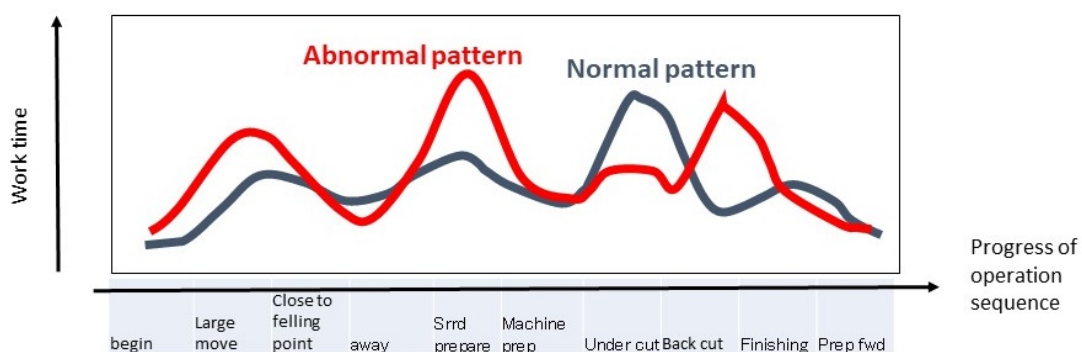

Figure 6. Operation process pattern. We know the normal and abnormal of the operation by comparing the patterns.

## 6. CONCLUSION - EXTENSION AND EXPECTATION OF SMART CHAINSAW –

Smart chainsaw promote operational productivity through fine management of work safety.

Data of chain saw through operation can be transmitted to a smart phone of the worker, and stored for daily report. He can transmit the data to an account managing PC, and the data can be processed to know the productivity and also the maneuver safety.

The digital daily report system can be a standard for occupational and project management for field operations.

## REFERENCE

Toshio NITAMI, Sooil Suk and Ryohei KONDO (2016), Information functioning for portable forestry machinery and the management possibility, Abstracts of JFA 127.

## O-14

### Physical Effects of Hinge Shape on Chainsaw Felling Direction in *Chamaecyparis obtusa*

Makiko Nagao<sup>1</sup> and Yozo Yamada<sup>1</sup>

<sup>1</sup> Graduate School of Agriculture, Ehime University, 3-5-7 Tarumi, Matsuyama, Ehime  
790-8566, Japan

\*Corresponding author: Tel: + 81-89-946-9665

E-mail: [yamada.yozo.fi@ehime-u.ac.jp](mailto:yamada.yozo.fi@ehime-u.ac.jp)

**ABSTRACT:** In Japan, most felling operations are performed manually by chainsaw because of the steep and difficult terrain. The average productivity per worker is approximately 5 m<sup>3</sup> per day, and accident rates remain constant. Approximately 60% of fatal chainsaw accidents occur during bucking and felling operations, mainly due to an irregular felling direction, which is typically caused by unevenness in the hinge cut into the felling surface. We performed a pulling experiment using wires to clarify the physical function of the hinge during manual felling operations. We found that when the hinge was uneven, a moment was produced toward the thicker side of the hinge and increased as the hinge surface area increased. Consequently, a larger, uneven hinge shifts the actual felling direction away from the optimum direction.

**Keywords:** Chainsaw felling, Felling direction, Hinge shape, Physical effect, Pulling experiment

#### 1. INTRODUCTION

High-performance forestry equipment has been in widespread use in Japan since 1985, and logging systems using these machines produced approximately 60% of the gross timber produced in 2012. However, timber harvesters see little improvement in felling operations because steep and rough terrain forces them to conduct most felling operations manually, using chainsaws. Productivity and safety have gradually improved in Japanese forestry; however, the average productivity per worker remains at approximately 5 m<sup>3</sup> per day, and the frequency of accidents remains constant at approximately 30‰, which is 12.5 times greater than all industries. Because of the delay in mechanization, forestry continues to be one of the most dangerous forms of employment in Japan.

Chainsaw felling operations are responsible for approximately 57% of fatal accidents in forestry (Yamada 2016), mainly because of irregular felling direction, which leads to 33% of fatal tree-felling accidents through lodged trees. Irregular felling direction is thought to be mainly due to unevenness in the hinge cut into the felling surface. An uneven hinge is similar in shape to a triangle. There are two types, varying in the position of the opposite top of a given bottom side: the border of the stem (Type A) and near the center of the felling surface (Type B). Novices are apt to make a Type A hinge when they incorrectly perceive the precise position of the top of the chainsaw blade. A Type B hinge can be formed when a chainsaw operator corrects a Type A hinge or makes a back cut in a large tree using a normal chainsaw with a short saw chain. The Type A hinge has a particularly negative effect on the felling direction.

In Japan, artificial forest resources have been experiencing constant growth, and mature forests more than 41 years old represent approximately 66% of the total area of artificial forests. Thus, the number of trees with diameters greater than 60 cm increases yearly in Japan. Moreover, the national Green Employment project has contributed approximately 1,000 new workers to the Japanese forestry sector since 2003. Generational change has been promoted effectively by Japanese foresters (Forest Agency 2015). However, educating and training new forestry personnel to improve their knowledge and techniques remains a challenge. Techniques for felling large-diameter trees are in danger of disappearing in the near future because of increased felling demand, aging experts, and longer thinning periods over the past four decades.

For these reasons, Technologizing Techniques was created to document techniques for felling large-diameter trees and analyze felling techniques to establish efficient training systems (Uemura 2015). However, few previous studies have examined felling techniques experimentally in Japan. In this study, we implemented a pulling experiment to clarify the physical function of the hinge in tree felling. We compared hinge shape and area between a normal parallel hinge and a Type A triangle hinge.

## 2. RESEARCH METHODS

We used stems from 21 hinoki (Japanese cypress, *Chamaecyparis obtusa*) trees with a diameter at breast height (DBH) under 20 cm. Trees were harvested from a 44-year-old hinoki stand in the Kome-no-no experimental forest at Ehime University 1 month before the experiment. All stems were cut to 2.1 m in length, and logs used ranged 11–18 cm in diameter at the bottom end. Their moisture content was between 57.3% and 100% when the experiment was performed.

We used a chainsaw to create a felling notch and a back cut; felling notches were cut to approximately one third of the diameter, and upper cuts were inclined 60°. We

created three types of hinge (Figure 1): a parallel type, with a width of 10% of the diameter; a thin triangle type, with a maximum width of 10% of the diameter; and a thick triangle type, with a maximum width of 20% of the diameter. We performed back cuts at three heights (Figure 2): the same height as the felling notch undercut (low), two thirds the height of the felling notch undercut (normal), and four thirds the height of the felling notch (high). In total, the experiment had nine treatments, each of which was performed in triplicate, for a total of 27 tests. Logs with knots or branches on the felling surface were excluded from the experiment.

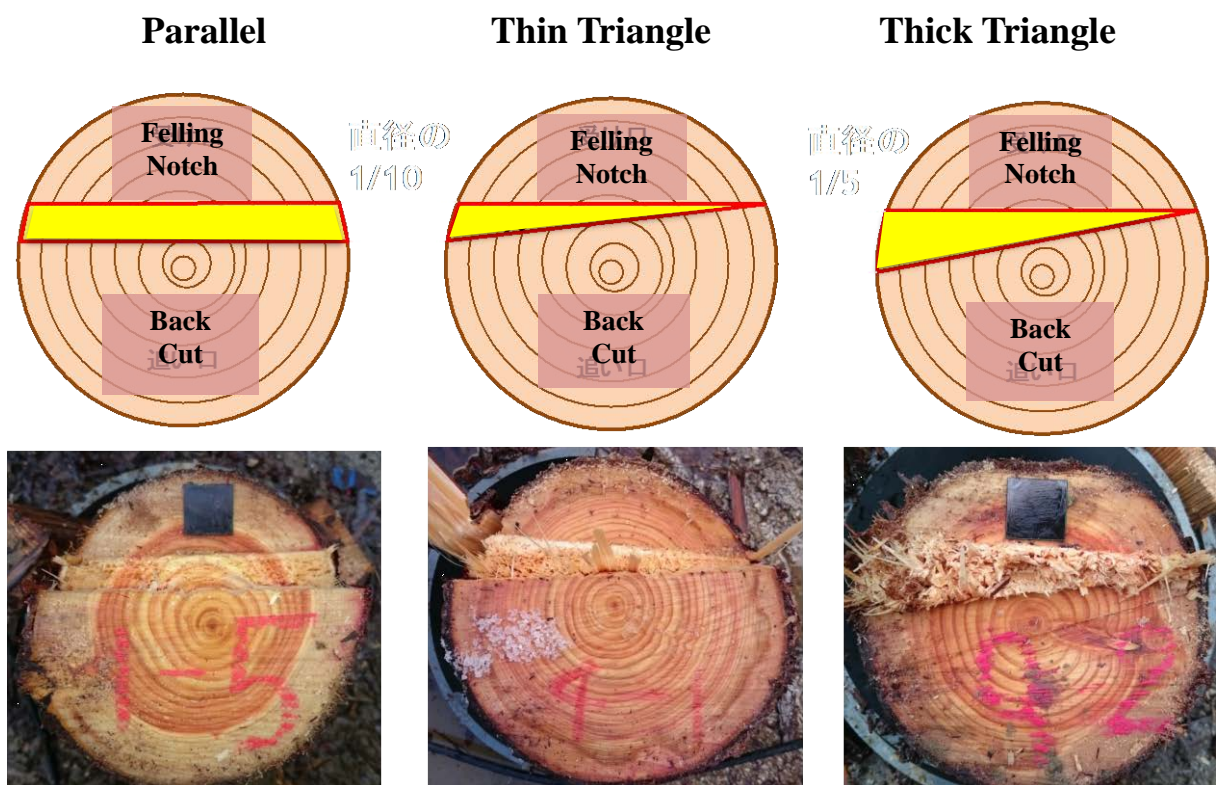

Fig. 1 Three shapes of hinge  
Yellow part shows hinge

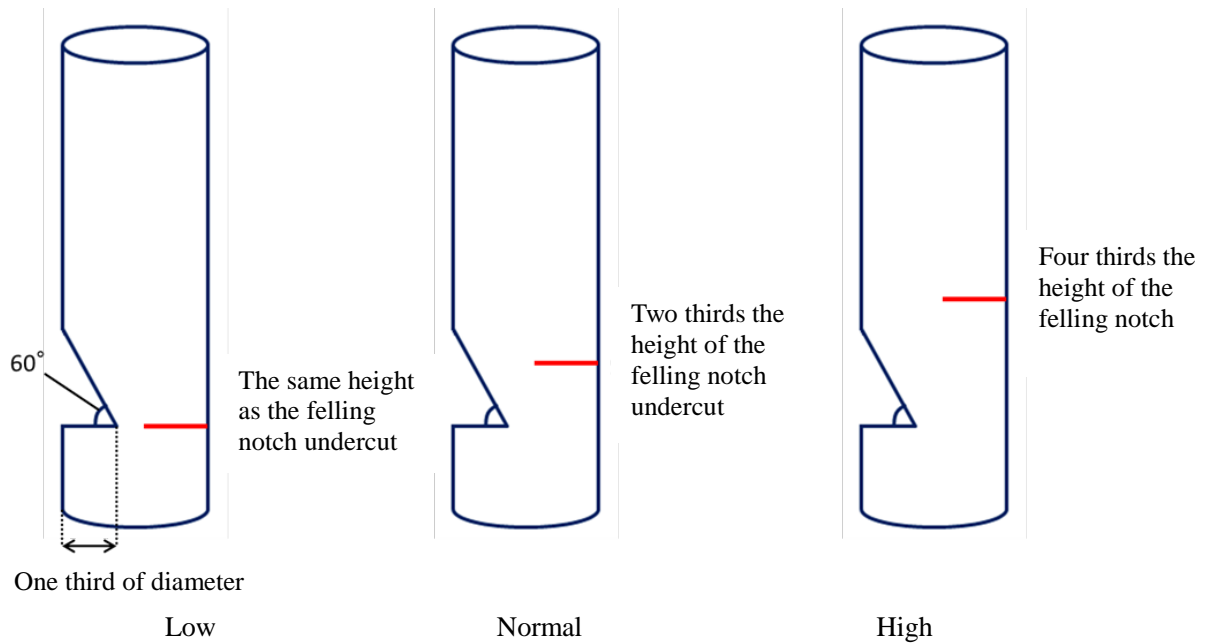

Fig. 2 Three heights of back cut

A support hole 20 cm in diameter was dug to a depth of 100 cm on level ground at the Higashino experimental field at Ehime University. A prepared log was inserted into the hole and fixed vertically with wedges. Two pulling wires were set at 100 cm above ground height and at right angles from the center of the felling surface of the prepared log. The felling notch of prepared log was set in face of the center direction between both pulling wires (Figure 3). We simultaneously pulled each wire horizontally using hand winches. Load cells (1.9 kN in load capacity) in the two wires measured the tension. When the back cut began to open during pulling, we adjusted the tension in both wires to be the same, then pulled in one-notch steps using the hand winch until the log fell. After felling, the hinge shape was photographed and its area measured using the image analysis program ImageJ.



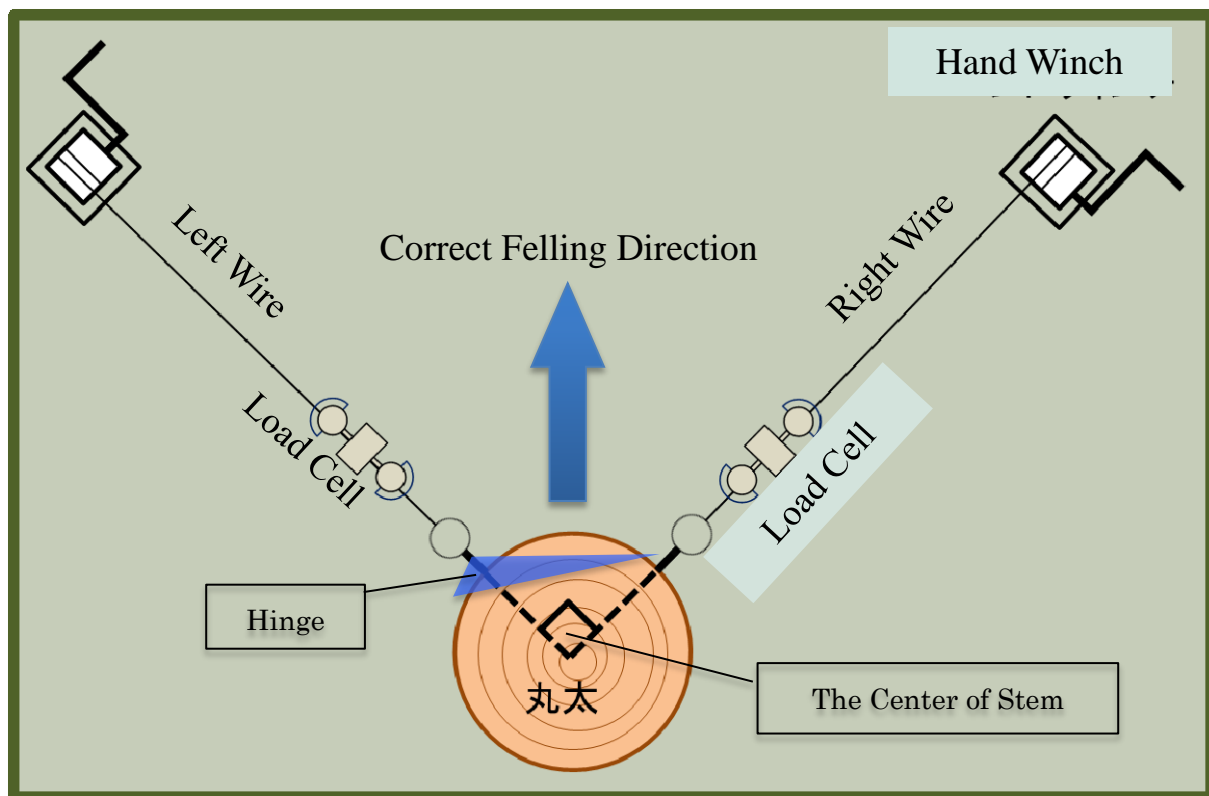

Fig. 3 Conceptual Diagram of Pulling Test

### 3. RESULTS AND DISCUSSION

#### 3.1. Wire tension

We found that the tension was higher in the right wire than in the left for both triangle shapes, whereas the tension was nearly the same for the parallel shape (Table 1). As the right wire pulled the thinner side of the triangle-shaped hinge, the thick triangle created more tension in the right than did the thin triangle. Figure 4 shows an example of the changes in tension in both wires for the thick triangle shape. The difference in tension between the wires appeared when measurement began, and as the back cut gradually widened, the tension in both wires increased, until the hinge finally broke at the maximum tension for each wire.

Table 1. Results of pulling tests

Low Height	Parallel	Thin Triangle	Thick Triangle
Left Tension (N)	249.1	197.2	200.8
Right Tension (N)	258.1	285.4	299.0
Resultant Force (N)	359.1	350.1	364.1
Resultant Angle (deg)	0.8	12.1	10.7
Moment (Nm)	1.5	5.5	10.1
Normal Height	Parallel	Thin Triangle	Thick Triangle
Left Tension (N)	210.5	78.1	320.6
Right Tension (N)	226.0	175.5	530.7
Resultant Force (N)	311.3	195.7	623.4
Resultant Angle (deg)	5.1	18.2	12.7
Moment (Nm)	1.7	5.5	15.9
High Height	Parallel	Thin Triangle	Thick Triangle
Left Tension (N)	352.3	151.8	400.3
Right Tension (N)	342.7	215.3	507.3
Resultant Force (N)	494.2	267.2	647.7
Resultant Angle (deg)	1.0	10.2	6.0
Moment (Nm)	0.5	4.5	13.3

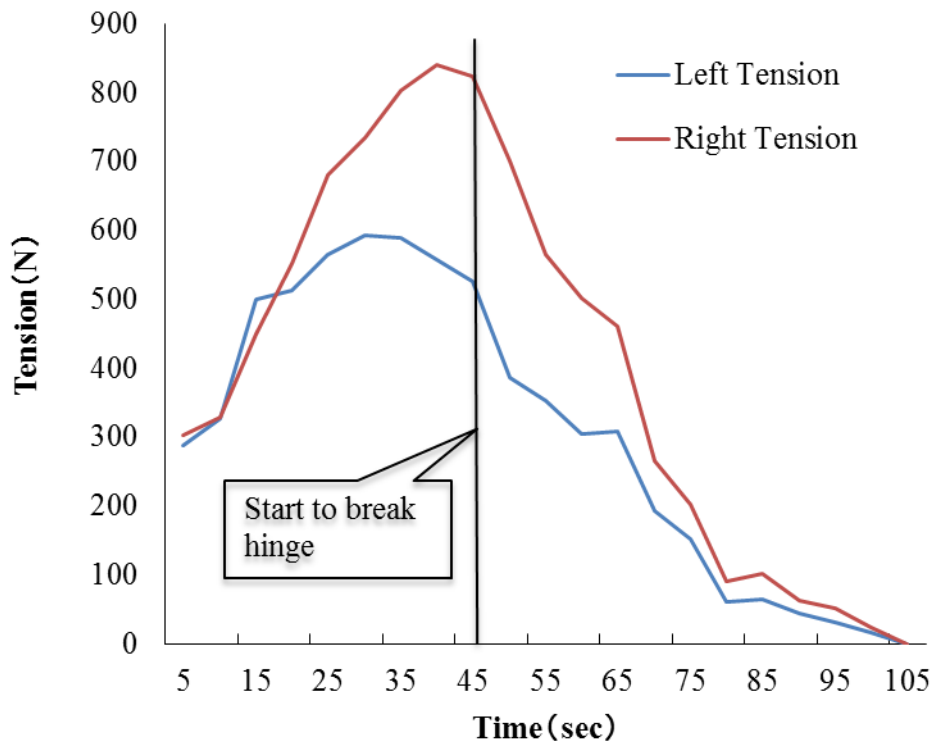

Fig. 4 Example of change of both tensions

### 3.2. Resultant forces

The resultant angle is the angle from the correct felling direction, which is the median line between both wires. Positive values indicate the right side angle from the correct direction, which represents the thinner side of the triangle shape hinge. Resultant forces and angles were calculated using the following formulas:

$$RF = \text{Square root } (TL^2 + TR^2), \quad (1)$$

$$RA = 45 - \tan^{-1}(TL / TR), \quad (2)$$

where RF is the resultant force (N), RA is the resultant angle ( $^{\circ}$ ), TL is the left tension (N), and TR is the right tension (N).

The thick triangle hinge yielded the largest resultant force for every back cut height; this trend was more noticeable in the normal and high treatments. The resultant angles for both heights were larger for the right side than for low height.

Figure 5 shows a strong significant correlation ( $r^2 = 0.8997$ ) between the resultant force and hinge area according to hinge shape. The vertical axis shows the resultant force (N), and the horizontal axis shows the hinge area ( $m^2$ ). The resultant force

increased exponentially as the hinge area increased; however, there were no significant differences between hinge shapes. Consequently, a larger hinge may generate stronger resistance power regardless of its shape and consequently delay the time to felling.

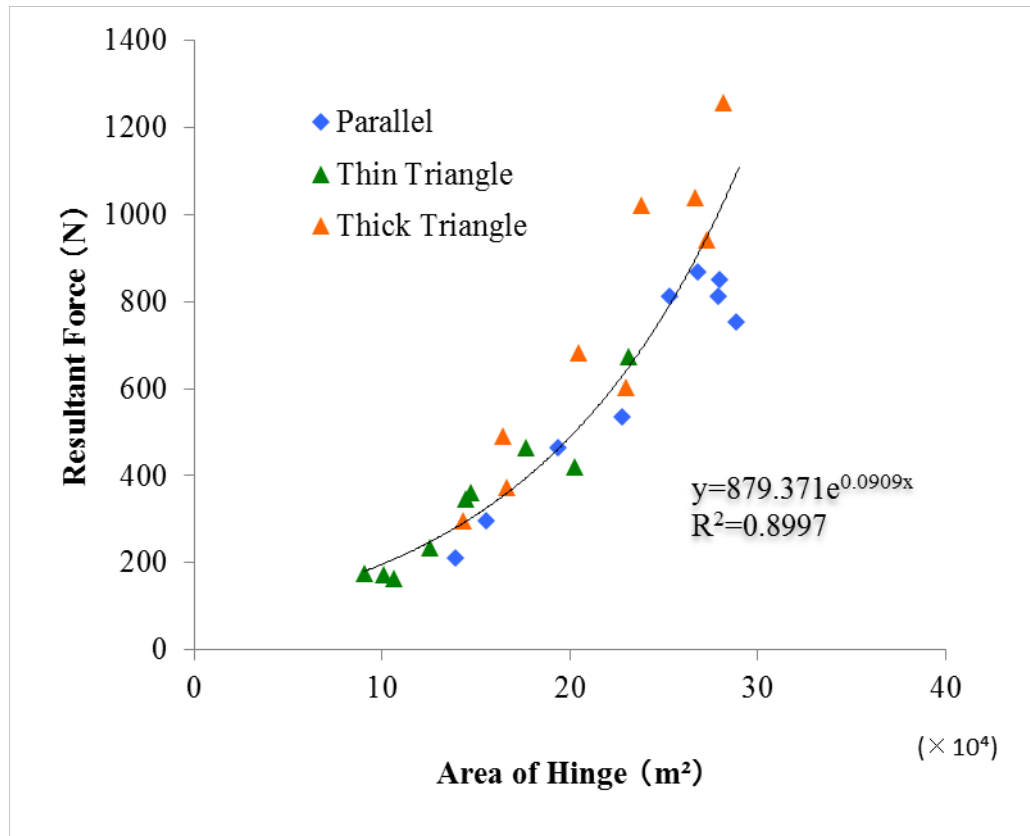

Fig. 5 Relation between resultant force and area of hinge

There was no significant correlation between the resultant angle and hinge area according to hinge shape (Figure 6); however, the resultant angle generally decreased with increasing hinge area. Moreover, the resultant angle differed by hinge shape. The resultant angles of the thick triangle felling notches were more positive (right side) than those of the thin triangle notches, whereas most parallel notches were concentrated around 0°.

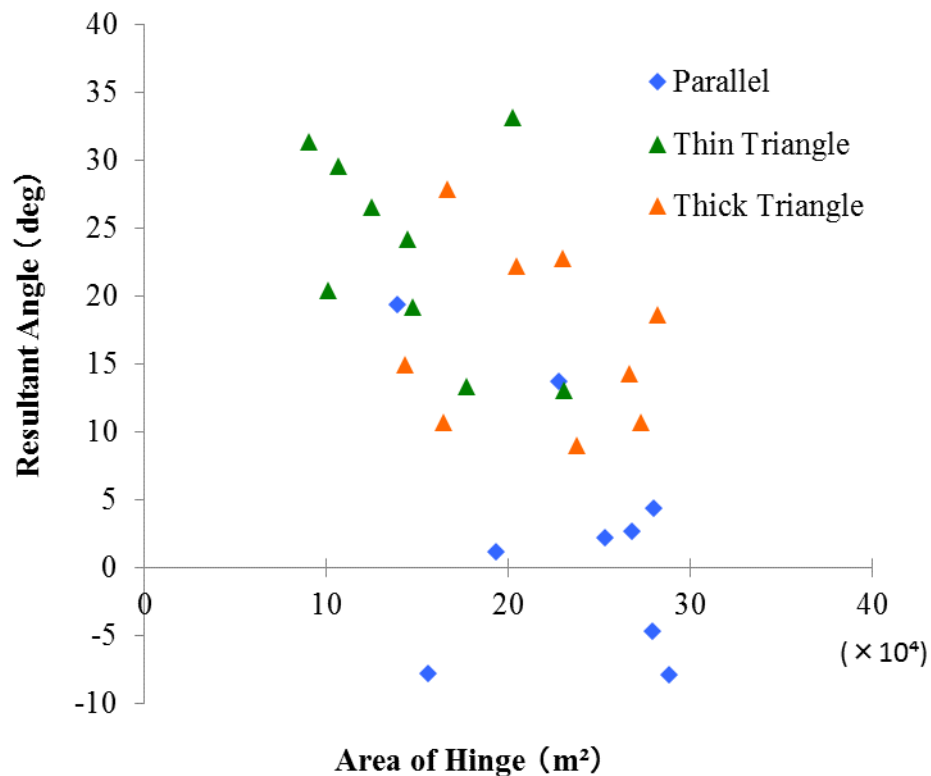

Fig. 6 Relation between resultant angle and area of hinge

### 3.3. Moment

As the resultant force acts at the center of the stem, the resultant force and angle generate a moment around the center of gravity of the hinge (Figure 7). The moment rotates the upper stem either clockwise or counterclockwise depending on the physical relationship between the center of the stem and the center of gravity of the hinge. If the center of gravity of the hinge is to the left of the stem center, moment is generated in a counterclockwise direction. Moment is calculated using the following formula:

$$M = RF \cdot d, \quad (3)$$

where M is the moment (N m) and D is the foot length of the perpendicular from the hinge center of gravity to the RF.

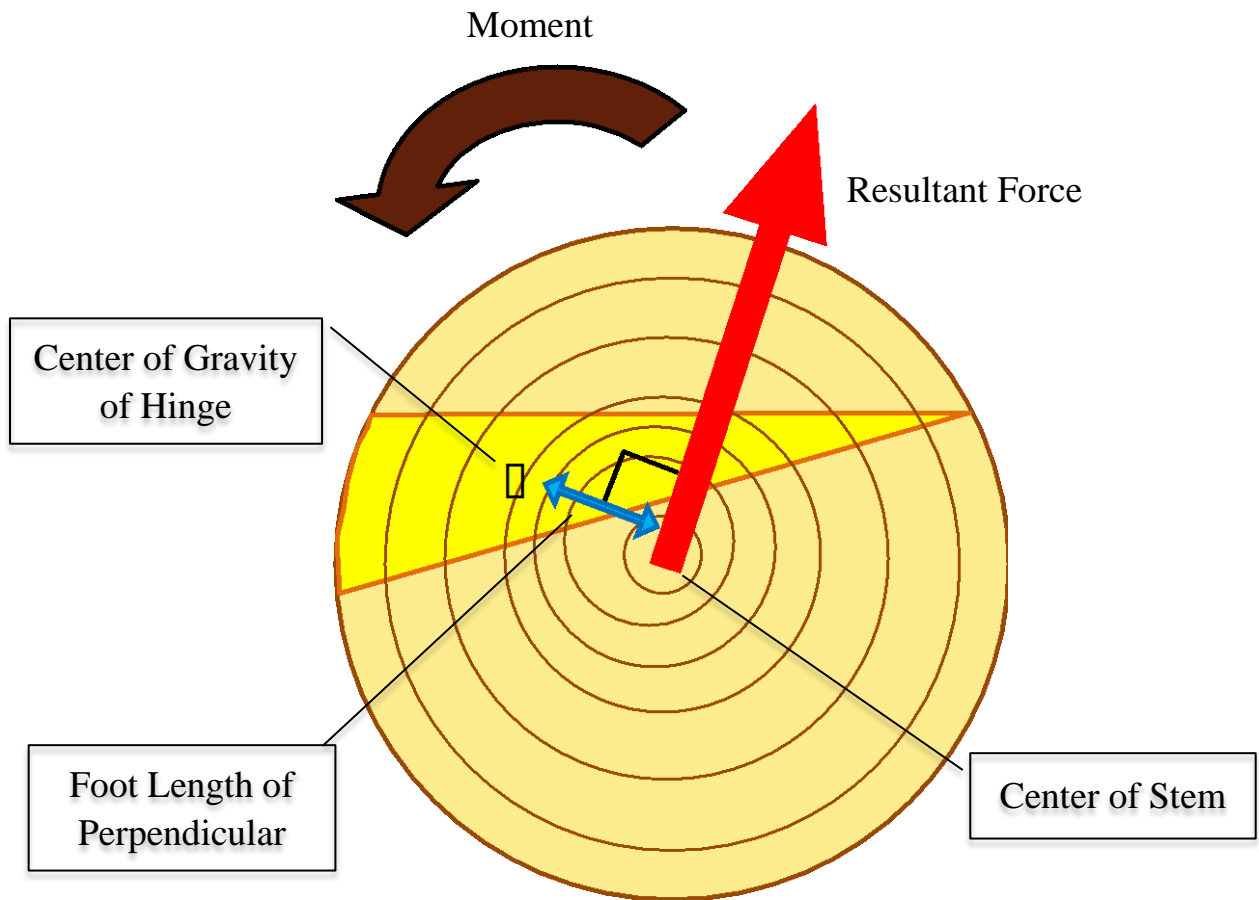

Fig. 7 Conceptual diagram of moment

The moments of the thick triangle notches were stronger than those of the thin triangle notches, whereas the moments of the parallel notches were very small, at less than 2 kN (Table 1). In the parallel shape, the foot length of the perpendicular was short because the hinge center of gravity was located nearer the center of the stem than those of the triangle notches. Normal back cut height caused the strongest moment, at approximately 16 N.

Figure 8 shows the relationship between moment and hinge area according to hinge shape. The vertical axis shows the moment (Nm), and the horizontal axis shows the hinge area (m<sup>2</sup>). Moments of the parallel notches were dispersed around zero regardless of the hinge area. There was a strong significant correlation ( $r^2 = 0.8348$ ) between moment and hinge area. The moment increased linearly with increasing hinge area; however, there were no significant differences among hinge shapes. Consequently, a large triangle hinge may generate stronger moment around the hinge center of gravity of the hinge, and the stem can be rotated toward the thicker side of the hinge.

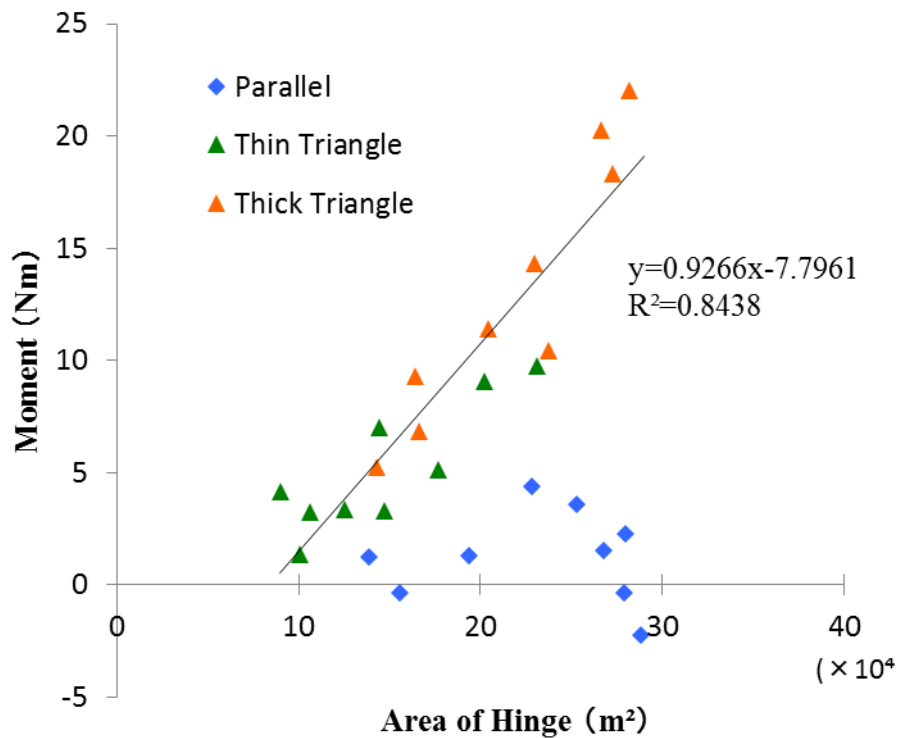

Fig.8 Relation between moment and area of hinge

#### 4. CONCLUSIONS

We performed pulling tests to clarify the physical function of hinge shape in tree felling by chainsaw. We found that resultant forces increased exponentially as hinge area increased and that moment increased linearly as hinge area increased when the hinge was triangular. Based on these results, we estimate that a triangular hinge may have a greater impact on felling direction, depending on its area, whereas parallel hinges have almost no influence on felling direction. A triangle hinge generates a resultant force at the center of the stem, opposing the fall, and the resultant force and length of the perpendicular from the hinge center of gravity to the resultant force generate a moment around the hinge center of gravity. The moment rotates the upper stem toward the thicker side of the hinge, causing the tree to fall in an unplanned direction. Thus, it is very important to maintain parallel hinges in chainsaw felling operations to improve worker safety and productivity. This is even more important with larger diameter trees because such trees have larger hinges. Proper training in correct felling techniques is urgently needed and would help to reduce the number of lodged trees and work accidents.

This research clarified the physical function of chainsaw felling hinges; however,

there are limitations to the study. In our experiments, we pulled logs without upper stems or branches, although movement due to gravity in the upper tree acts at the hinge center of gravity. The effects of gravity on the upper tree vary as stems bend and with amount and allocation of foliage. Different experimental approaches may result in different findings from those described here. However, we think that the hinge function indicated by our study is correct and that the hinge generates the same resultant force and moment when the tree experiences any felling force. In the field, the hinge is broken and cut gradually from the back cut side and the thinner side of the hinge. Thus, the moment will change during hinge breakage. In this study, we measured the change in tension of both wires; however, our data were not precisely measured during the experiment, and hence we cannot perform further analysis. Moreover, wire tension may have been influenced by the internal composition and quality of the tree. We plan to perform more precise measurements to clarify hinge function.

#### **ACKNOWLEDGMENT**

We thank Mr. Kohno and Mr. Haikawa, engineers at the experimental forest at Ehime University, for their help and cooperation in performing our pulling tests.

#### **REFERENCES**

- Forest Agency (2015) Annual Report on Trends in Forests and Forestry Fiscal Year 2015, 23p, (in Japanese).
- Uemura, T. (2015) “Transaction and problems of felling techniques in Japan.” *J. Jpn. For. Eng. Soc.* 30(1), 5-10 (in Japanese).
- Yamada, Y. (2016) “Measure for working safety and health of forestry entities and feature of working accidents.” *For. Sci.* 78, 19-21 (in Japanese).



## **III. POSTER PRESENTATIONS**



## P-01

### Estimation of Forest Workers Environment under the Climate Change

ITAYA Akemi<sup>1</sup>

<sup>1</sup> Graduate School of Bioresources, Mie University, 1577 Kurima-machiya, Tsu, Mie, Japan

**Abstract:** Climate change is one of the most important issues in the world, which might decline labor productivity. Even now, forest operations have been carried out in the tough working environments. In this study, working environments were estimated using temperature and humidity under the climate change. The temperature - humidity index (THI) in forest areas in Japan were calculated using current (average during 1961-1990) and future (at 2050, CSIRO and MIROC-H) temperature and humidity raster which obtained from CliMond. As a result, THI were more than 80 would spread to northern areas than the current distribution under future climate conditions (CSIRO and MIROC-H). They might be double the current area. Therefore, studies on physiological load of worker and working wears under climate change will be more important.

**Keywords:** Temperature, Humidity, Slope, GIS

#### 1. INTRODUCTION

It is important to improve working environments for forest operations in order to reduce industrial accidents. For this reason, studies on physiological load of worker and working wears have been carried out (e.g. Wenbin et al., 1990; Shimizu and Sakai, 1994). However, climate change also has to be considered as a new issue for working environments. Global climate change might affect living and working environments, and create health threats for people (IPCC, 2014). Even now, forest operations have been carried out in the tough working environments. Therefore, it might become increasingly harsh. To solve this new problem, it is necessary to understand the extent of environmental change for forest workers under climate change.

In this study, working environments in forests were estimated using temperature and humidity under the climate change.

#### 2. MATERIALS AND METHODS

Forest workers environment under the climate change were estimated in Japan (Figure

1). Forests cover approximately 25 million hectares, occupying about two-third of the total land area of Japan. Such high coverage of forests has been maintained for more than a half century (Forestry Agency, 2009).

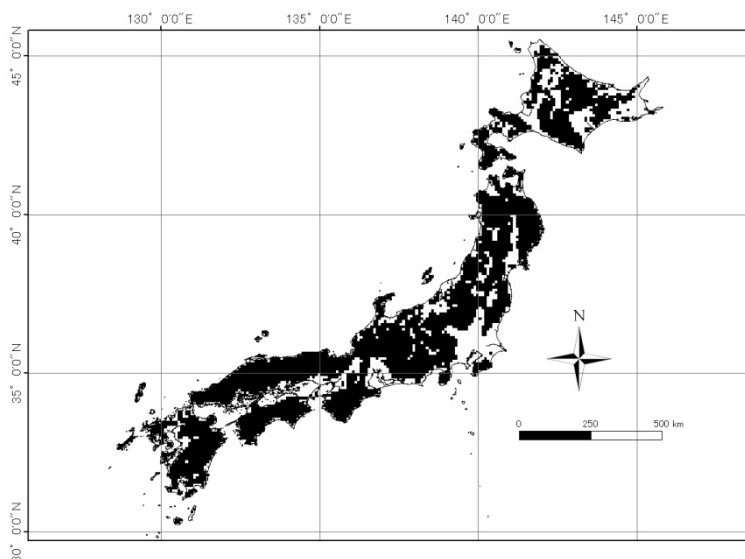

Figure 1 Study area with forest distribution. Black areas show forest distribution, which were obtained from MODIS (The Global Land Cover Facility).

Forest areas were obtained from MODIS (The Global Land Cover Facility, [www.landcover.org](http://www.landcover.org)), which was 5' x 5' spatial resolution. They were classified evergreen needle leaf forest, evergreen broadleaf forest, deciduous needle leaf forest, deciduous broadleaf forest and mixed forest in the global land cover data sets. As environmental data, daily maximum temperature and relative humidity at 3 pm in the current and 2050 (CSIRO A1B, MIROC-H A1B) from CliMond (<https://www.climond.org>) were used, which was 10' x 10' spatial resolution.

Temperature humidity indexes (*THI*) for each grid of forest was calculated for 12 months using daily maximum temperature (*T*, °C) and relative humidity at 3 pm (*RH*, %). As a *THI*, the highest value was selected among 12 months for each grid. Most people are quite comfortable when the index is below 70 and very uncomfortable when the index is above 80 to 85 (Thom, 1959).

$$THI = 0.81T + 0.01RH(0.99T - 14.3) + 46.3$$

### 3. RESULTS AND DISCUSSION

Figure 2 shows distribution of high THI under the current and future climate conditions. It was expected that areas where THI were more than 80 would spread to northern areas than the current distribution under both future climate conditions. They might be double the current area (Figure 3). Moreover, Even if it might not double, it was expected that THI might increase 1 or 2 in many areas (Figure 4). In Japan, forest workers have been rapidly aged and decreased. Improvement of working environment is a very important issue for decreasing industrial accidents and encouraging entrants. Studies on physiological load of worker and working wears under climate change will be more important.

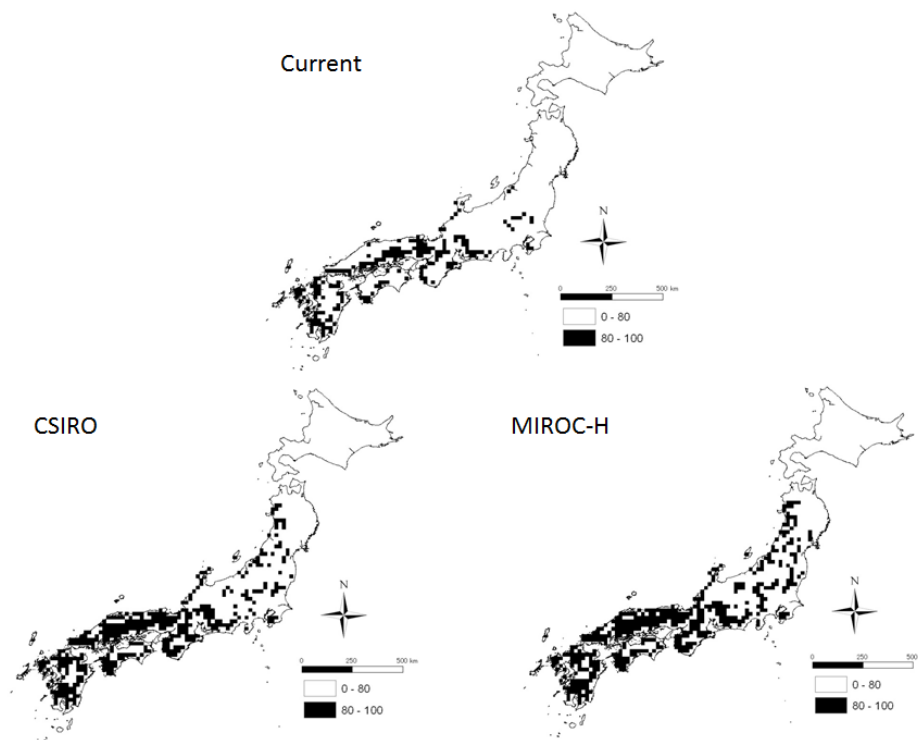

Figure 2 Distribution of high THI under the current and future climate condition. Black area show THI is more than 80. Most people are very uncomfortable when the index is above 80 to 85.

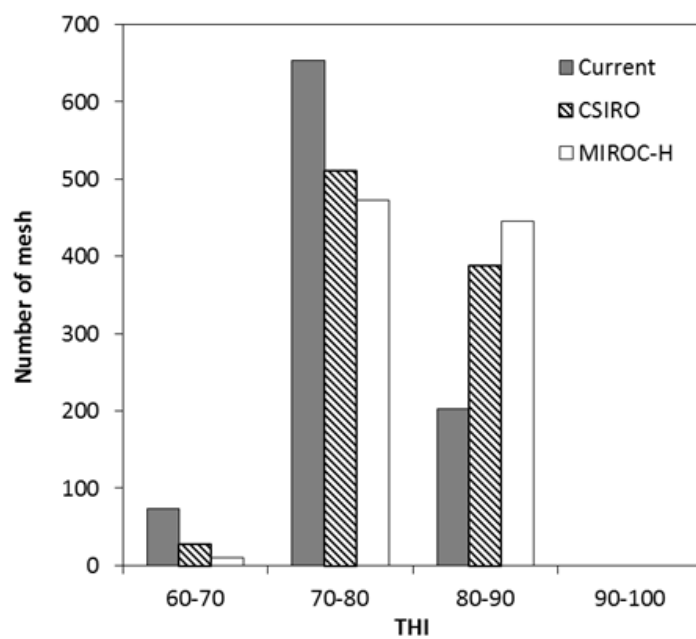

Figure 3 Frequency of THI under the current and future climate condition.

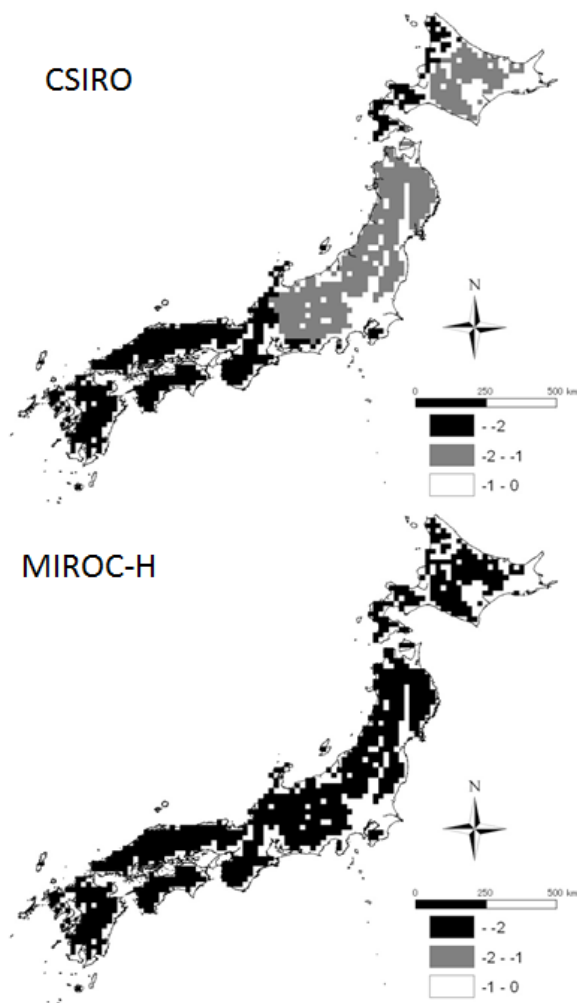

Figure 4 Amount of changes in THI under the current and future climate conditions.

## REFERENCES

- Forestry Agency (2009) State of Japan's Forests and Forest Management. 57pp. online, (<http://www.rinya.maff.go.jp/j/kaigai/pdf/countryreport-1.pdf>). accessed May 10, 2017.
- IPCC (2014) IPCC Fifth Assessment Report: Working Group II Report "Climate Change 2014: Impacts, Adaptation, and Vulnerability": 709-764.
- Shimizu H. and Sakai H. (1994) Improvement of function and comfortableness of forestry-workers' clothing (I) : Function demanded for forestry-workers' clothing. *Journal of the Japan Forest Engineering Association* 9: 53-60.
- Thom E.C. (1959) The discomfort index. *Weatherwise* 12: 57-60.
- Wenbin L., Fushimi T., Inoue S. (1990) Workers' heart-rates and continuous work periods for forest brush-cutting work on a steep area. *Journal of the Japanese Forestry Society* 72: 216-222.

## **P-02**

### **Method for Determining Felling Directions to Prevent Damage to Saplings**

Hiroaki Shirasawa<sup>1,\*</sup>, Dai Otsuka<sup>1</sup> and Masashi Saito<sup>1</sup>

<sup>1</sup> Faculty of Agriculture, Shinshu University, 8304 Minami-Minowa-mura, Kamiina-gun, Nagano 399-4598, Japan.

\*Corresponding author: Tel: + 81-265-72-1512 E-mail: [shirasawa@shinshu-u.ac.jp](mailto:shirasawa@shinshu-u.ac.jp)

**Abstract:** In felling operations, chainsaw operators are required to reduce the impact of felling trees on saplings, in order to form successfully the next generation of mature trees. This paper proposes a mathematical formulation to minimize damage to saplings by felling trees, while giving consideration to the spatial arrangement. The main decision variables in their formulations are binary variables on felling directions of each felling tree. Once formulated, problems are solved with a commercial MIP (Mixed Integer Programming) solver and then the solutions are compared with the actual result obtained from logging surveys.

**Keywords:** Felling damage, Felling directions, Spatial optimization, Mathematical programming

#### **1. INTRODUCTION**

Timber harvesting techniques related to “reduced-impact logging” (RIL), which is a term used to refer to sets of guidelines for mitigating deleterious impacts of logging operations, have been successfully applied to not only tropical forests but also a variety of forests (Putz et al., 2008). One of the RIL techniques in felling operations is directional felling where desired felling directions are planned based on pre-logging forest inventories and then implemented. There are two main objectives of directional felling (Sist, 2000): The first objective is to place the felled trees in appropriate locations to ensure the efficiency and safety of the operations of felling and extracting logs from forest to near skidding trails or cable ways. The second objective is to prevent damage to saplings, namely future crop trees. For example, in order to achieve the above objectives, main guidelines for planning directional felling recommend felling trees in the direction of existing canopy gap.

In this paper, we present a mathematical formulation for planning directional felling



using pre-logging forest inventory data, where a set of felling directions are determined and the degree of damage to saplings by felled trees is minimized. Then, problem instances generated from real forest inventory data are solved with a commercial solver and the solutions are compared with the actual result obtained from post-logging surveys.

## 2. MATERIALS AND METHODS

### 2.1. Formulation

The directional felling planning problem is formulated as a 0–1 integer programming problem. It is desirable to define directly the objective function as minimizing the damage to saplings by felled trees, but because of the difficulty in quantification, we substituted the area of square cells vegetated by saplings and covered by felled trees. The objective function is the total area of the cells and as follows:

$$\min. \quad a \sum_{i \in I} x_i \quad (1)$$

where  $I$  is the set of the cells where saplings grow and the felled trees have the potential to cover,  $x_i$  is a binary decision variable that equals 1 if the cell  $i$  is covered by felled trees, 0 otherwise, and  $a$  is the area of a square cell.

On the other hand the constraints are:

$$\text{s.t.} \quad \sum_{k \in K} y_{jk} = 1 \quad \forall j \in J \quad (2)$$

$$\frac{\sum_{j \in J} \sum_{k \in K} p_{jk}^i y_{jk}}{M} \leq x_i \quad \forall i \in I \quad (3)$$

$$x_i \in \{0, 1\} \quad \forall i \in I \quad (4)$$

$$y_{jk} \in \{0, 1\} \quad \forall j \in J, \forall k \in K \quad (5)$$

where  $J$  and  $K$  is the set of trees to be felled and felling directions, respectively,  $M$  is a sufficiently large positive (e.g.,  $M = |J| \times |K|$ ),  $p_{jk}^i$  is a binary constant equal to 1 if the cell  $i$  is covered by the tree  $j$  felled in the felling direction  $k$ , 0 otherwise, and  $y_{jk}$  is a binary decision variable equal to 1 if the tree  $j$  is felled in the felling direction  $k$ , 0 otherwise. Constraint (2) ensures that each tree must be felled in only one direction while constraint (3) specifies cells covered by at least one felled tree. Constraints (4) and (5) impose binary requirements on decision variables.

### 2.2. Problems and solution methods

Problem instances were generated at each of the two sites in the Mt. Naramoto-yama national forests in Nagano Prefecture. We defined the set of felling directions as 32 directions spaced at  $16/\pi$  intervals, but it is redundant to assume that all trees to be

felled have 32 felling directions, because felling directions are usually restricted as felled trees come near skidding trails, considering the efficiency of extraction operations following felling operations. Hence, felling directions of each tree were restricted in that manner, in consideration of the location of the tree and the skidding trails. The length of a side of the square cell where saplings grow was assumed to be 1 m, that is  $a = 1 \text{ m}^2$ . Figure 1 shows the distribution of the standing trees and square cells. Table 1 exhibits the characteristics of each problem instance.

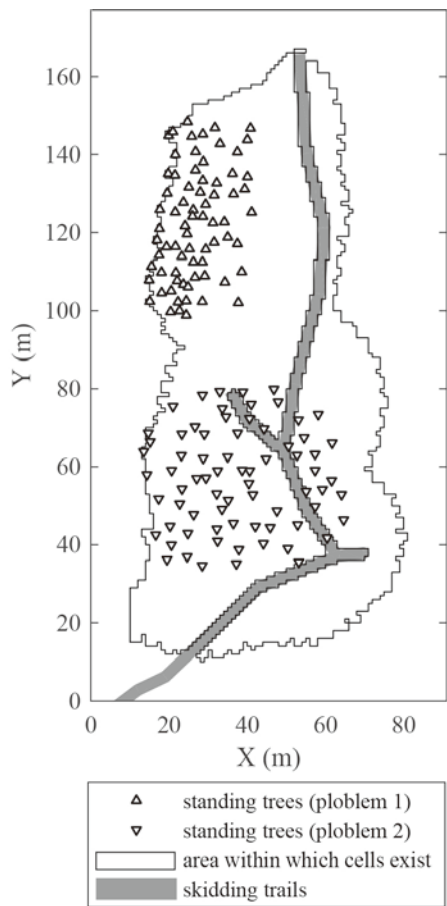

Figure 1. Distribution of the standing trees and square cells

Table 1. Characteristics of problem instances

Problem	Number			
	trees	cells	binary variables	constraints
1	72	3,081	3,843	3,153
2	72	4,488	5,805	4,560

The two problems were solved by the state-of-the-art commercial MIP solver, CPLEX 12.7 (IBM 2016) on a 3.00 GHz Intel Core i7-6950X processor having 32 GB of physical memory. We used the CPLEX default settings except that a time limit of 12 hours was set.

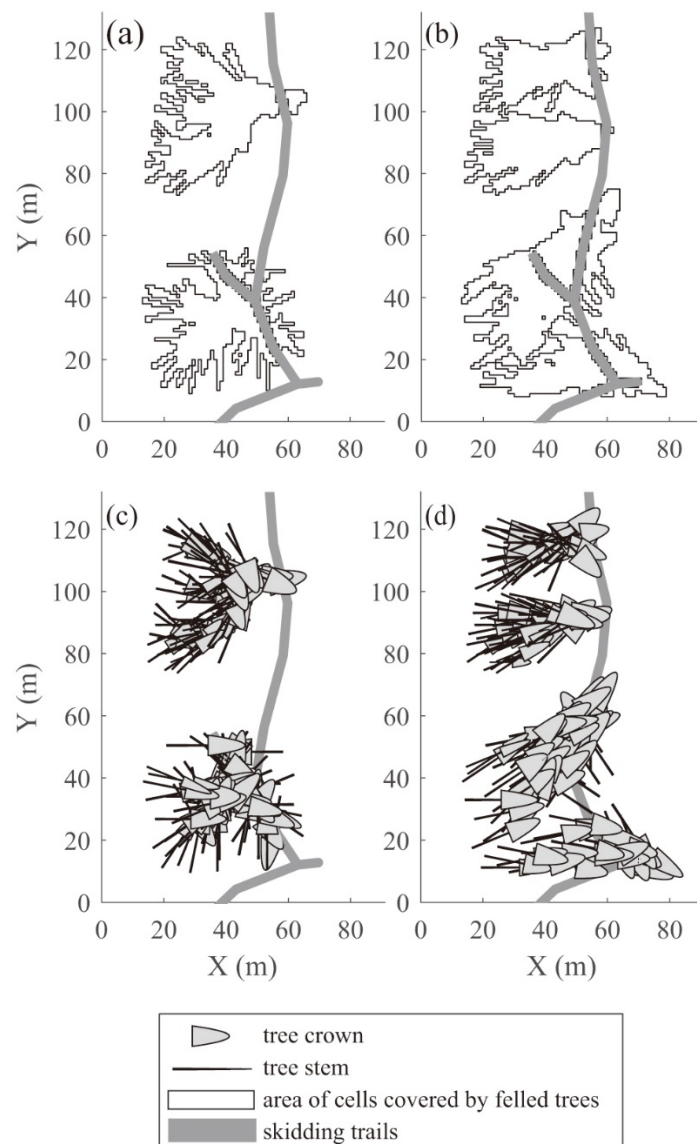

Figure 2. Comparison between the result of the solution (a, c) and the actual one (b, d)

### 3. RESULTS AND DISCUSSION

The both problems could not be solved to optimality within the time limit because of the problem size. The relative gaps between the best integer solution and the best bound available were 23.4 % in problem 1 and 31.3 % in problem 2. Figure 2(a) and (c) show the felled trees in the solutions and the objective function values were 1,086 m<sup>2</sup> in

problem 1 and 935 m<sup>2</sup> in problem 2. On the other hand, figure 2(b) and (d) show felled trees actually obtained from logging surveys and the objective function values were 1,321 m<sup>2</sup> and 1,686 m<sup>2</sup>. The objective function values in the solutions were 17.8 % in problem 1 and 44.5% in problem 2 lower than the actual ones.

#### **4. CONCLUSIONS**

We considered the optimization problem of finding the felling directions that minimize the total area covered by felled trees, and proposed a 0-1 integer programming formulation of the problem. In addition, we tried to solve real-world instances of the problem with the solver. As a result, even though it was not possible to obtain the exact solutions, the set of felling directions was found by which the area, which is directly linked to damage to saplings, decreases considerably as compared to that actually observed in logging survey.

#### **REFERENCES**

Putz, F. E., Sist, P., Fredericksen, T., & Dykstra, D. (2008). Reduced-impact logging: challenges and opportunities. *Forest ecology and management*, 256(7), 1427-1433.

Sist, P. (2000). Reduced-impact logging in the tropics: objectives, principles and impacts. *The International Forestry Review*, 3-10.

IBM. (2016). ILOG CPLEX Optimizer. <http://www-01.ibm.com/software/integration/optimization/cplex-optimizer/>

## P-03

### Study on Prediction of Sapling Damage Area by Felling and Skidding.

Dai Otsuka<sup>1</sup>, Masashi Saito<sup>2\*</sup>, Hiroki Matsunaga<sup>1</sup> and Tatsuhito Ueki<sup>2</sup>.

<sup>1</sup> Graduate School of Agriculture, Shinshu University, 8304 Minamiminowa, Nagano 399-4598, Japan.

<sup>2</sup> Faculty of Agriculture, Shinshu University, 8304 Minamiminowa, Nagano 399-4598, Japan.

\*Corresponding author: Tel: + 265-77-1652 E-mail: [m\\_saito@shinshu-u.ac.jp](mailto:m_saito@shinshu-u.ac.jp)

**Abstract:** In order to optimize logging method for shelterwood, it is a prerequisite that the damage area of the understory caused by harvesting has been clarified. In the past method using basement facilities as explanatory factors such as forest road, it is not suitable for evaluation of natural regeneration with random distribution. This study, firstly, survey individual level spatial distribution of damage in *Chamaecyparis obtusa* dominated shelterwood stands, and then identified the damage range. After that, we adapt a predicted damage to the dataset of damages observed at the adjacent survey site and compare the logging damage whole-tree or stem-only collection.

**Keywords:** Shelterwood, Logging damage, Forest operations, Spatial analysis

## 1. INTRODUCTION

Reduction of damage to regeneration trees at the time of generation change is a big problem of the shelterwood operation. In general, the damage of the regeneration tree when performing such harvesting is indicated by the number ratio. However, since the direction of the skidding operation is determined by the road network and slope direction, it is thought that the damage is biased. Nevertheless, quantitative research on spatial correlation with forest road network arrangement and work direction is minor. Siren *et al.* (2015) are trying to model work by GLMM in the selective cutting stand. As a result, it is reported that the damage rate of the individual decreases in inverse proportion to the distance of the fallen tree located in the immediate vicinity of the object. These methods make it possible to evaluate the spatial damage potential more than the placement situation of the standing trees. On the other hand, optimization of harvesting work is required to minimize damage, and the expected spatial distribution of the damage rate must be variable for obtaining the solution. We tried modeling the

contact frequency between fallen tree and regeneration tree as an explanatory variable, and found an accuracy of estimation of 60% or more (Otsuka *et al.*, 2017). However, even with the same movement route, it is considered that the contact by the branches is greatly different between the whole-tree collection versus the stem-only collection. In this study, we measured damages of regeneration trees during felling and skidding, and identified the damage range of the regeneration trees by whole-tree collection. Next, we compared a damage estimated on the result and the actual case where collecting was done with stem-only collection.

## 2. STUDY SITE AND METHOD

The study site is the 1180 forest compartment of the Naramotoyama national forest in central Nagano Prefecture. The forest team is located at an altitude of 1,000 m to 1,160 m and belongs to an inland climate. The shelterwood is dominated by cypress, natural regeneration by seedling occurs, and it is approaching the time of generational change (Fig. 1.).

In order to clarify the damage at the time of whole-tree collection, we cut down 2 shelter trees that do not affect each other and investigated the damage of the update tree distributed within the disturbed range (Fig. 2) . In this study, we made a damaged tree excluding less than 25% of the branches broken out (Kondo *et al.*, 2009). However, it is not possible to specify the point of occurrence of damage after completion of harvesting. For this reason, in the below, we first extracted individuals within the range of felling and dealt with the data assuming that they separated from damage during collecting.



Fig.1 Inside the forest



Fig.2 Collecting condition

Analysis was carried out in the following procedure. First, the coverage area of the felling shelterwood was estimated using a parabola model as crowns, stems were measured, and it was taken as the disturbed range. We extracted the actually damaged regeneration trees within that range. Next, from the data set of the proximate forest with similar conditions, the damage amount in the whole-tree collection was predicted.

Finally, we compare the amount of damage to the stem-only collection actually observed.

### 3. RESULTS

The regeneration trees affected at the time of felling were included 95% in the parabola crown model (Takeshita *et al.*, 1985; Hayashi *et al.*, 1997) of fallen trees, so it was appropriate as a projection of the disturbed range (fig. 3). In addition, most of the damage occurred within 70% of the estimated crown width (Fig. 4). Likewise, all the damage occurred within 40% of the area where the crown width was extended in the direction of collecting at the time of skidding. Since all damage was within the above range, we assumed that all the regeneration trees inside of the covering range as damaged. We compared this result with the stem-only collecting.

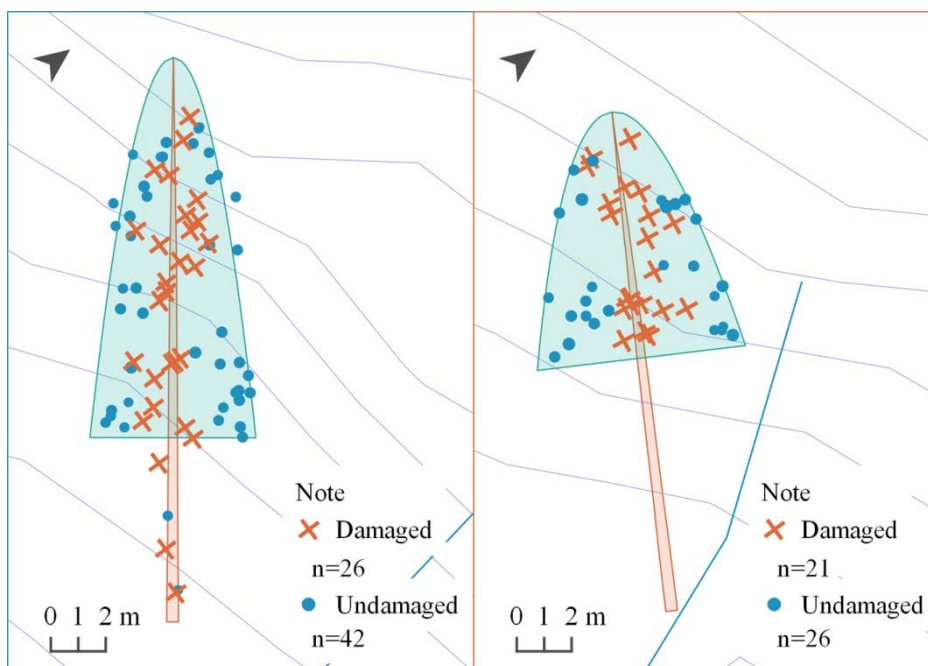

Fig.3 Location of damaged trees



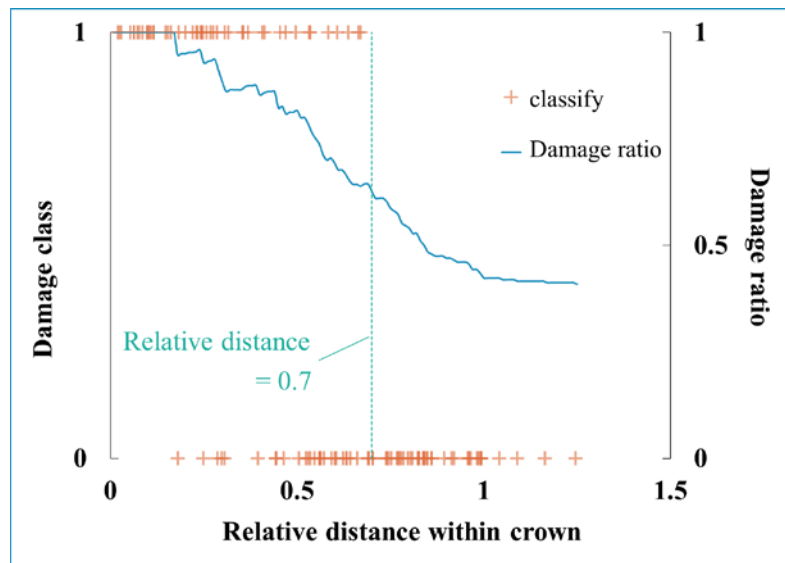

Fig.4 Relative distance within crown width and damage rate

Projection of the disturbed range using GIS in the neighboring forest where harvesting actually occurred included 579 regeneration trees. Compared to 441 damage regeneration trees (measured values) when performing the stem-only collection, it was presumed that the influence of the whole-tree collection on the regeneration trees will be greater (Fig. 5). It should be noted that this result does not take into account fluctuations in incidence event rates that differ for each individual regeneration tree.

#### 4. CONCLUSIONS

It became possible to estimate the damage range at felling and skidding at the time of whole-tree collection. It is estimated that damage to the regeneration trees will increase because the influence range of collection is expanded for the whole-tree collection in the forest where the skidding distance is long. In such forest stands, from the viewpoint of protection of regeneration trees, we should use stem-only collection. Manual limbing in the forest is a bottleneck in harvesting operation, but should be done with whole-tree when the collection distance is short and the range of disturbance is limited to the neighborhood of the forest road.

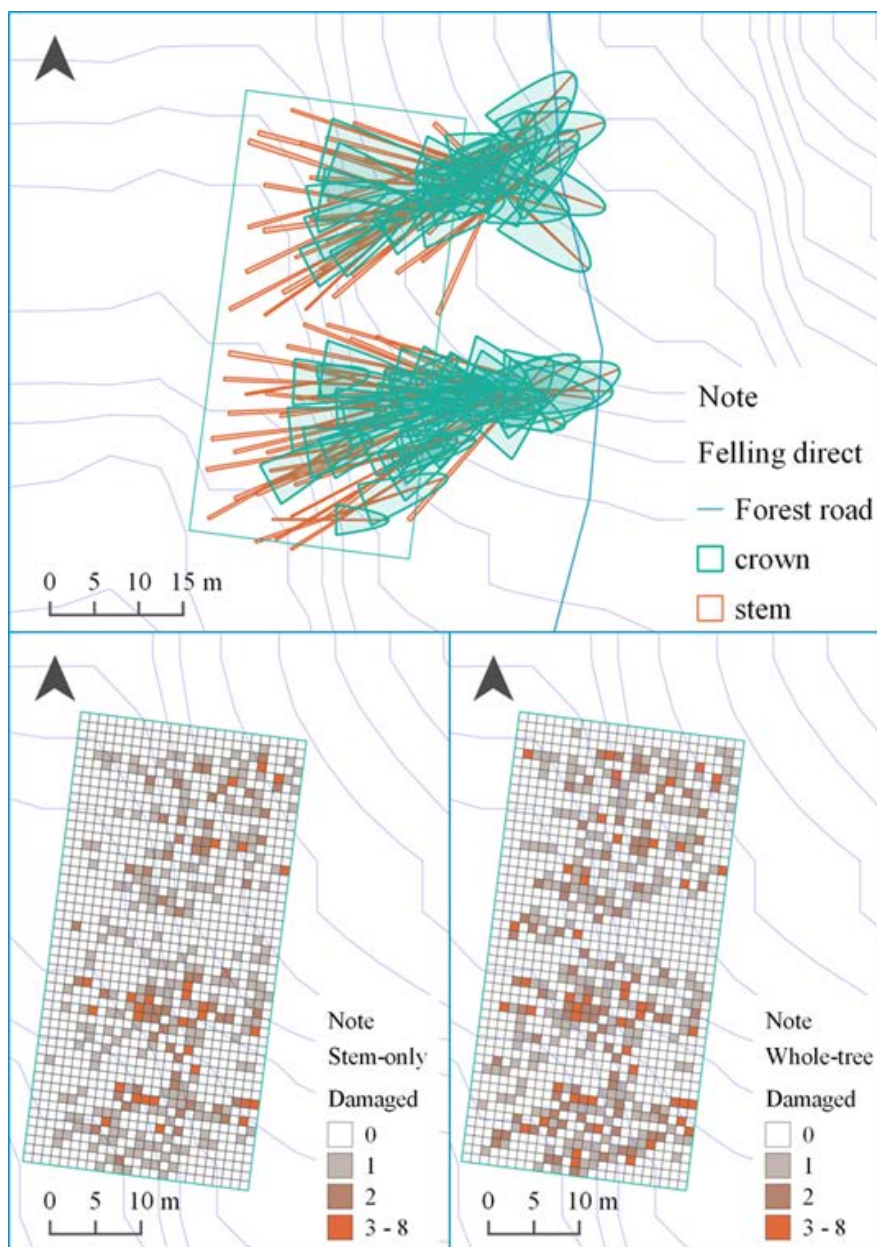

Fig.5 Distribution of damaged trees

## REFERENCES

- Hayashi, S and Takahashi, Y (1997) “On the modeling of tree’s figure: Case of *Cryptomeria japonica* and *Chamaecyparis obtusa*”. J. Jpn. For. Soc. 79(4):222-228 (in Japanese with English Summary).
- Kondo, M. Imai, M. Miyazaki, T. Oka, M. and Sasaki, T. (2009) “Examination of methods for reducing damage to lower-story trees accompanying upper-story thinning in a multi-storied stand: The effects of felling upper-story trees uphill and pruning upper-story trees prior to thinning. J. Jpn. For. Eng. Soc. 24(1):3-10 (in Japanese with English Summary).

- Otsuka, D, Saito, M, Moriguchi, K, Matsunaga, H, Kinoshita, W, Nomizo, Y, Ueki, T.  
(2017) “Distribution of damage to understory caused by logging in Hinoki dominated shelterwood stand”. Transactions of the Japanese Forestry Society 2017. P166 (in Japanese).
- Sirén, M. Hyvönen, J. and Surakka, H. (2015) “Tree Damage in Mechanized Uneven-aged Selection Cuttings”. Croat. j. for. eng. 36(1):33-42.
- Takeshita, K. (1985) “Construction Analysis of Sugi Forest (*Cryptomeria japonica* D. Don) by Parabolic Modeling of Crown Form”. Bulletin of the Kyushu University Forests 55:55-104 (in Japanese with English Summary).

## P-04

### **Muscle Load, Heart Rate, and Change in Body Temperature Associated with Tree Felling Work Using a Chainsaw as Revealed by Motion Analysis**

Syohei KAMEYAMA<sup>\*1</sup>, Takuyuki YOSHIOKA<sup>\*2</sup> and Kouki INOUE<sup>\*2</sup>

<sup>\*1</sup> Graduate School of Bioresource Sciences, Nihon University, 1866 Kameino, Fujisawa, 252-0880, Japan

<sup>\*2</sup> College of Bioresource Sciences, Nihon University, 1866 Kameino, Fujisawa, 252-0880, Japan

**Abstract:** This study was to measure Muscle load, Heart rate and Body surface temperature quantity from workers. The work posture that we surveyed was every five seconds and analyze the reproduction image which recorded felling of the chain saw worker appeared of, standing, 30°trunk flexion, 90°trunk flexion and half kneeling. The measurement of the muscle load did it with four places of rectus abdominis muscle (right, left), the erector muscle of spine (right, left). The condition of the slant assumed it flat, 10 degrees, 20 degrees and set 12 conditions in total. The experiment is performed in the room to do temperature, the humidity constantly. Four schoolboys that a subject is normal. As for the erector muscle of spine, the left had a bigger muscle load than the right. In addition, 30°trunk flexion has a biggest muscle load together the left right, and there are the fewest muscle load; 90°trunk flexion showed a tendency. When an inclination rises, half kneeling a muscle load decreases showed a tendency.

**Keywords:** Chain saw, Muscle load, Work posture, Movement analysis

## 1. INTRODUCTION

With respect to Japan's forestry industry, the physical strain on workers and work-related injuries have steadily declined thanks to the use of harvesters, processors, forwarders, and other efficient forestry machinery and the construction of forest road networks. That said, use of such efficient forestry machinery in Japanese forests is hindered by the prevalence of steep terrain. On such terrain, tree felling must be carried out using chainsaws.

However, chainsaw use places a large physical strain on workers and can lead to the development of lower back pain. It has been reported that the proportion of forestry workers suffering from lower back pain is higher among those using chainsaws than

among those who do not use chainsaws.

We previously clarified the relationship between terrain and frequency of different working postures using motion analysis of still images captured from a video recording of a chainsaw worker felling a tree. Based on the results of this previous study, we attempted to clarify the physical effects on workers of different postures assumed during tree felling work using a chainsaw. Specifically, we measured the muscle load, heart rate, and change in body temperature when postures simulating working postures are maintained, with the goal of identifying working postures that place the least physical strain on a worker during tree felling work.

## 2. MOTION ANALYSIS

To identify the frequency of different working postures during tree felling work using chainsaws, we conducted a motion analysis experiment at a private forest site in Mishima City, Shizuoka Prefecture. The motion analysis method entailed visual inspection of still images captured at 5-s intervals from a video recording of a chainsaw worker felling a tree. In addition, we classified slope angles as flat, moderate, and steep, and measured the upper-body and knee angles that occurred under each slope condition. The mean slope of the study site was 8.3°.

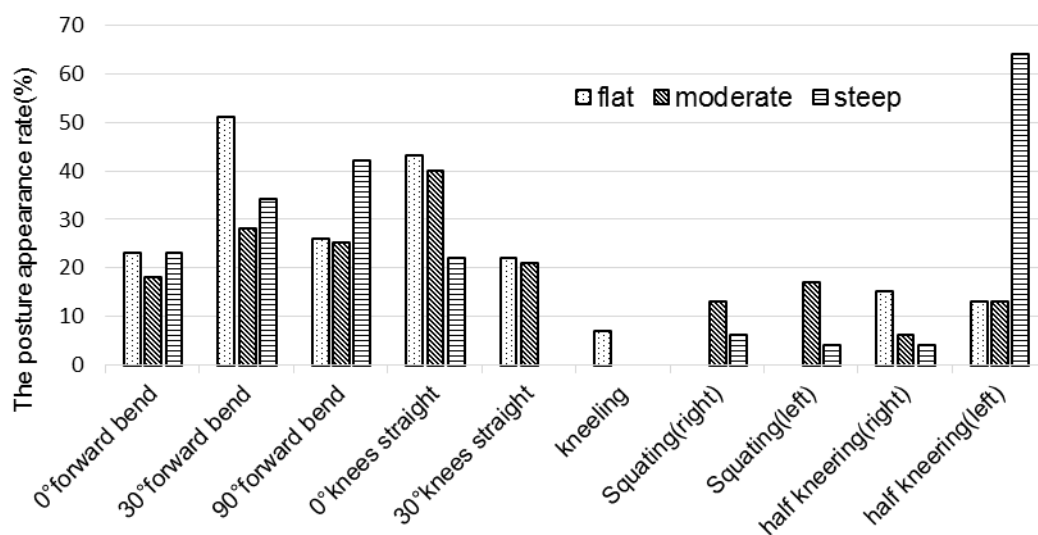

Fig. 1 Working posture obtained through motion analysis

The frequencies of different working postures obtained through motion analysis are presented in Fig. 1. On flat terrain, the most common working postures were 30° forward bend of the upper body (51%) and both knees straight (0°, 43%). On

moderately sloping terrain, whereas substantial differences in the frequency of different upper-body angles were not observed, the most common knee angle was  $0^\circ$  for both knees (40%). On steep terrain, the most common working posture was  $90^\circ$  forward bend of the upper body ( $42\%$ ) and knees bent in a half-kneeling posture ( $64\%$ ). Based on these results, the four most frequently observed working postures were selected as working postures in the experiment on muscle load, heart rate, and change in body temperature: (1) straight, (2)  $30^\circ$  forward bend, (3)  $90^\circ$  forward bend, and (4) half-kneeling (See Fig. 2, postures during work).

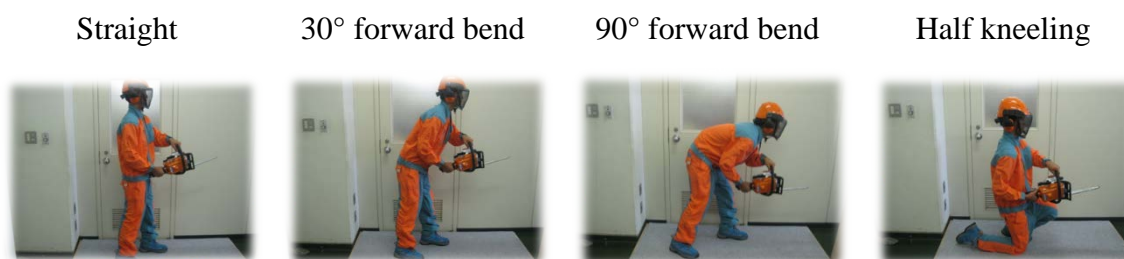

Fig. 2 Postures during work

### 3. RESEARCH METHODS

As summarized in Table 1, the subjects consisted of four healthy male students with no disease of the lumbar region. As the experiments were conducted in the summer, they were carried out in the laboratory to ensure consistent temperature and humidity.

Table 1. Experimental conditions

Test subjects	4 male students
Average age	$22 \pm 1$
Average height	$177 \pm 9$ cm
Average weight	$73 \pm 10$ kg
Average temperature	$28^\circ\text{C}$
Average humidity	60%

Based on the results of the motion analysis, four working postures—erect,  $30^\circ$  forward bend,  $90^\circ$  forward bend, and half-kneeling—were selected for measurement. For all postures, the stance entailed moving the left foot forward, and moving the right foot backwards, with the feet spaced shoulder-width apart. Muscle load was measured in four locations reported to be involved in lower back pain: rectus abdominis muscles (left and right) and erector spinae muscles (left and right). As illustrated in Fig. 3, measurements were taken using a MQ16 electromyogram recorder (Marq-Medical, Farum, Denmark). Differences in mean values were statistically analyzed.



Fig. 3 MARQ16(left)、HEXOSKIN Heart rare monitor(center)、Thermographic camera(right)

The slope conditions investigated included flat, 10° slope, and 20° slope, for a total of 12 posture × slope conditions. Postures were maintained for 5 min. In the case of forward bend postures, the subjects were allowed to return to an erect position once every minute. Heart rate and changes in body temperature were also measured at the same time as muscle load. Heart rate was monitored using HEXOSKIN wearable monitors (Marq-Medical). Heart rate was monitored over 15 min, including 5 min prior to the experiment and 5 min after the experiment in order to obtain a resting heart rate and post-experiment heart rate.

Changes in body temperature were monitored using an InfReC series H2640 thermographic camera (Nippon Avionics Co., Ltd., Tokyo, Japan). As in the case of heart rate, temperature was measured over 15 min, including 5 min prior to the experiment and 5 min after the experiment, at a total of 12 locations, six upper-body locations and six lower-body locations. Fig. 3 shows the MQ16 electromyogram recorder, HEXOSKIN heart rate monitor (center), and thermographic camera (right) used in this study.

## 4. RESULTS AND DISCUSSION

### 4.1 Muscle load

Significant differences in muscle load were not observed between the right and left rectus abdominis muscles or for different slopes ( $p > 0.05$ ). However, as can be seen from the load on the right and left rectus abdominis muscles for different work postures (Fig. 4), muscle load tends to increase with increasing forward bend angle. In addition, muscle load for the half-kneeling posture tended to be on the same order as the high muscle load for the 90° forward bend posture.

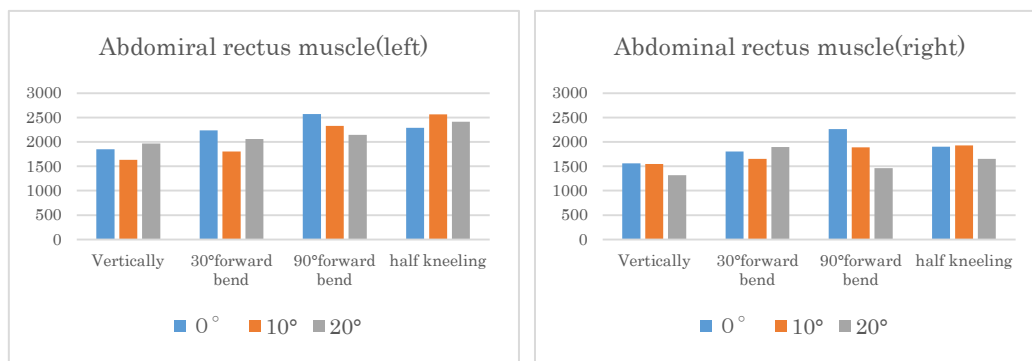

Fig. 4 Muscle load (rectus abdominis) result

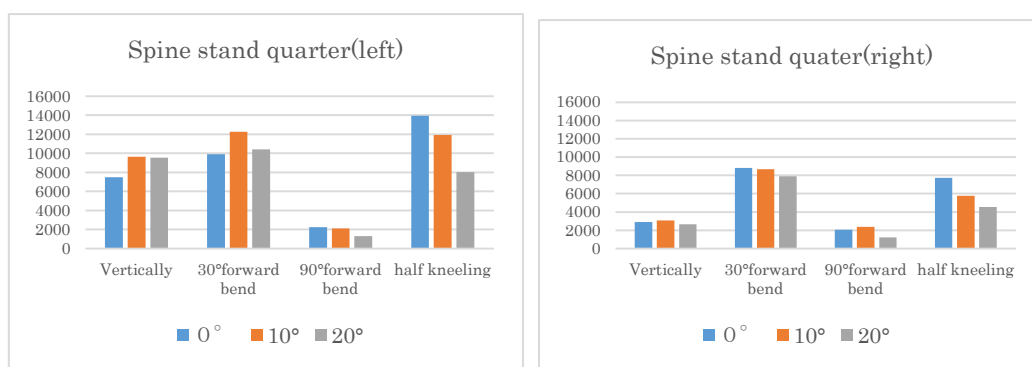

Fig. 5 Muscle load (spinal column erector muscle) result

Muscle load results for the left and right erector spinae muscles are shown in Fig. 5. Load on the left erector spinae muscle was 44.8% greater than on the right erector spinae muscle ( $p < 0.05$ ). This is believed to be due to the design of the chainsaw, which requires the operator, whether they are right-handed or left-handed, to hold the forward handle with their left hand and to hold the rear handle with their right hand. This arrangement causes the operator’s trunk to lean to the left when performing felling work, increasing muscle load on the left side.

In the half-kneeling posture, muscle load tended to decrease with increasing slope. On both the left and right sides, the 30° forward bend posture tended to result in the greatest muscle load, whereas the 90° forward bend posture tended to result in the lowest muscle load. Given the unexpected finding that the 90° forward bend posture results in the lowest muscle load, we conducted the experiment a second time.

#### 4.2 Heart rate

The change in heart rate for different slopes is shown in Fig. 6. Heart rates for both 0° and 20° slopes were higher than for the 10° slope. No significant difference in heart rate was observed between 0° and 20° slopes ( $p > 0.05$ ). Heart rate tended to increase with



increasing slope.

The half-kneeling posture on a 20° slope resulted in the highest heart rate. No significant difference in heart rate was observed between erect, 30° forward bend, and 90° forward bend postures ( $p > 0.05$ ).

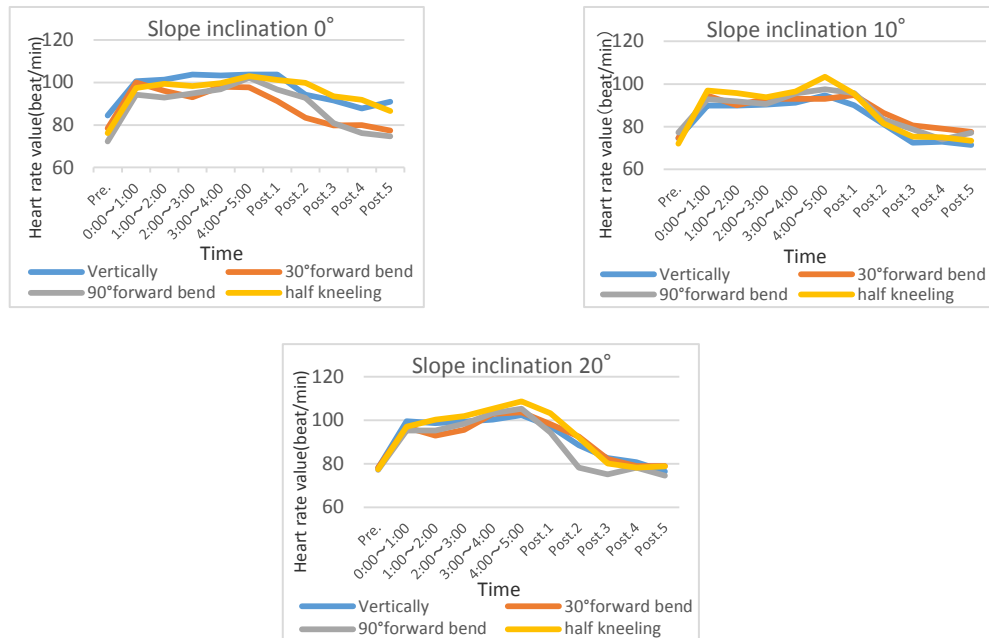

Fig. 6 Changes in heart rate value differences in slope

### 4.3 Change in body temperature

Fig. 7 shows the changes in skin temperature over time. As can be seen in the figure, the erect posture resulted in the smallest change in body temperature, while the 90° forward bend and half-kneeling postures resulted in similar, large changes in body temperature. In the upper body, the greatest changes in body temperature were observed in the area around the elbow and the abdomen. This increase in body temperature is believed to be due to the increased load on the arms when holding the chainsaw.

In the lower body, the greatest changes in body temperature were observed for the shins and the tops of feet. This is believed to be due to the increased load on the legs resulting from a shift in the center of gravity to a leg when a certain posture is maintained.

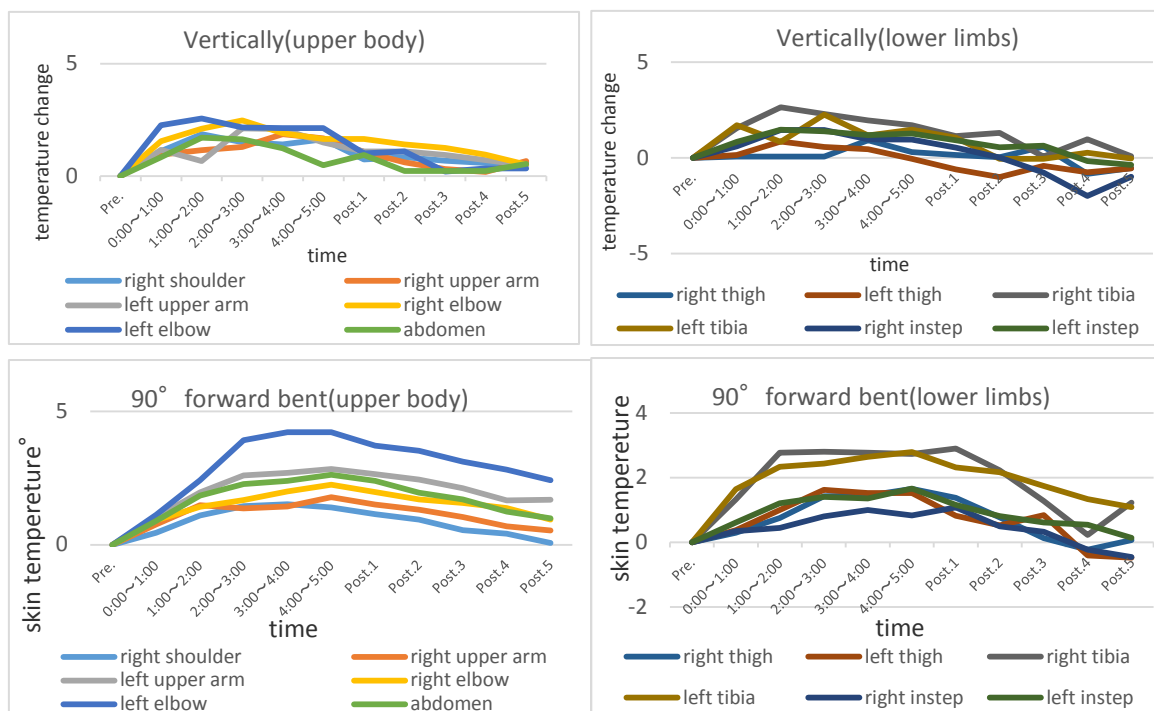

Fig. 7 Change in skin temperature over time

#### 4.4 Muscle load for 90° forward bend

The experimental method used in this study was to measure muscle load in four locations—namely the rectus abdominis muscles (left and right) and erector spinae muscles (left and right)—while test subjects maintained postures ranging from 0 to 90° forward bend on a flat surface. Postures were maintained for a period of 1 min. Changes in muscle load at different forward bend angles are shown in Fig. 8. As can be seen in the figure, loads on both the rectus abdominis and erector spinae muscles tended to increase with increasing forward bend angle up to 60°. For forward bend angles greater than 60°, the load on the rectus abdominis muscles remained constant (i.e. at the high rate), whereas the load on the erector spinae muscles tended to decrease with increasing forward bend angle. In addition, the 90° forward bend posture resulted in the lowest load on the erector spinae muscles.

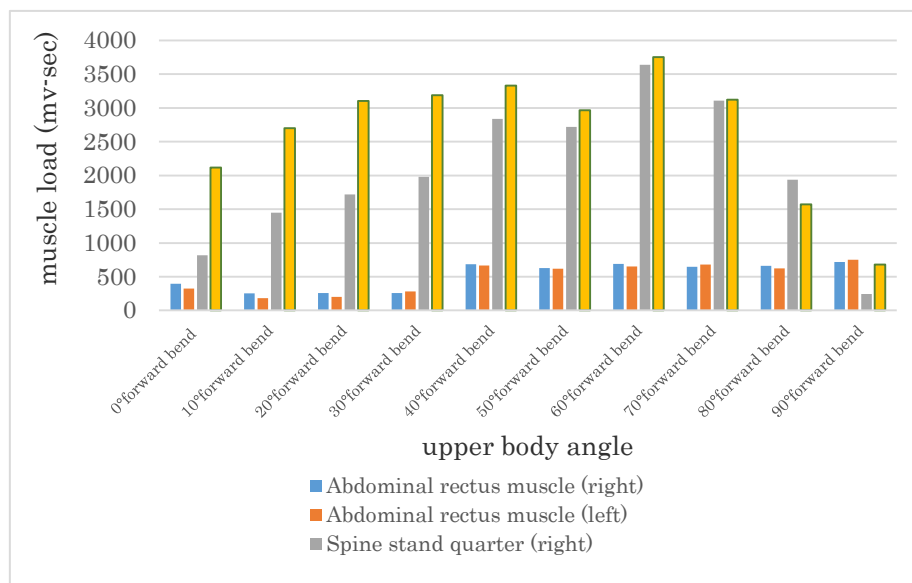

Fig. 8 Muscle load by upper part of the body angle

## 5. CONCLUSIONS

In both experiments, substantial differences in muscle load were not observed between the right and left rectus abdominis muscles or for different slopes. However, muscle load tended to increase with increasing forward bend angle. For the half-kneeling posture, the load on the erector spinae muscles tended to decrease with increasing slope. Among the different working postures, the 30° forward bend posture resulted in the greatest muscle load, suggesting that this posture may increase the risk of developing lower back pain. The load on the erector spinae muscles tended to increase with increasing forward bend angle up to a certain point and to decline thereafter, with the lowest muscle load resulting from the 90° forward bend posture. This result suggests that, at higher forward bend angles, the load is shifted from the lumbar region to the leg and back muscles. Therefore, in future studies, we will need to also measure the load on the leg and back muscles.

Substantial differences in heart rate were not observed for different forward bend angles. However, the half-kneeling posture resulted in the highest heart rates. In terms of slope, heart rate tended to increase with increasing slope, suggesting that tree felling work on steep terrain places greater physical strain on workers.

With respect to changes in body temperature, the greatest increases in body temperature resulted from the half-kneeling and 90° forward bend postures. In terms of specific body locations, substantial increases in temperature were observed in the upper arm, abdomen, shin, and the tops of feet. In terms of posture, the half-kneeling posture resulted in the greatest increase in body temperature.

The above results, which show that muscle load, heart rate, and body temperature increase with increasing slope, provide clear evidence that work on steep slopes increases the physical strain on workers. Accordingly, whenever possible, tree felling work using efficient forestry machinery is preferred on steep terrain. In terms of working posture, based on small measurements of muscle load, heart rate, and body temperature, the erect posture was shown to cause the least physical strain on workers. From this result, it is recommended that workers maintain an erect posture when performing tree felling work using a chainsaw. When this is difficult, it is recommended that work be performed with a forward bend between 0° and 30°. Furthermore, for the half-kneeling posture, muscle load tended to decrease with increasing slope. Therefore, it is recommended that workers use the half-kneeling posture when performing tree felling work on slopes.

## P-05

### **Effects of Final Cutting as a Preventive Measure of Pollinosis and the Tama Timber Certification System on the Local Logging System and Productivity**

Shohei KAMEYAMA<sup>1,\*</sup>, Takuyuki YOSHIOKA<sup>2</sup> and Koki INOUE<sup>2</sup>

<sup>1</sup> Grad. Sch. of Bioresour.Sci., Nihon Univ., 1866 Kameino, Fujisawa 252-0880, Japan

<sup>2</sup> Coll. of Bioresour. Sci., Nihon Univ., 1866 Kameino, Fujisawa 252-0880, Japan

\*Corresponding author, E-mail: [kameyama.shohei.0110@gmail.com](mailto:kameyama.shohei.0110@gmail.com)

**Abstract:** In this study, changes in the logging systems of registered certified contractors as well as the distribution of timber in the local market were investigated, and the effect of the measure on the local logging system, on productivity, and on timber distribution were examined. The research focused on the ‘Tama timber center’ of the local market and that of registered certified logging contractors. As a result, the Tokyo Tama area increased its log production as a result of the use of final cutting project as a ‘preventive measure of pollinosis’. Also, the switch to final cutting, new purchase of high performance forestry machines and the advancement of worker technology influenced the logging system and log productivity. However, the log production volume forward appears to be decreasing. Thus, the condition of Tama area of after the project should be continually investigated.

**Keywords:** final cutting, logging system, productivity, timber distribution

#### **1. INTRODUCTION**

The forest area of the Tokyo is 78,566 ha, which accounts for about 40% in Tokyo area. About 60% the forest in the Tokyo Tama area are artificial forests, and about 90% are in an age class over 9 years old (Tokyo Metropolitan, 2015). At present, many forests in Tokyo are available. However, the forest in Tokyo has not been sustainably-managed due to the small scale dispersion of ownership and the declining timber price. And, Japanese cedar account for a majority of artificial forests, and as they enter high age classes their amount of pollen increases. For that reason, Tokyo has seen an increase in the number of patients suffering from pollinosis.

The Tokyo Metropolitan Government initiated ‘preventive measure of pollinosis’ in 2006. Reducing the number of Japanese cedars is the most effective measure for

preventing pollinosis. However, thinning for the purpose of forest management has little effect on pollinosis. Tokyo initiated its 'preventive measure of pollinosis' with a 10years plan beginning in 2006. The 'preventive measure of pollinosis' include the 'final cutting project', 'colorful forest project', and 'reforestation project'. The aim of the 'final cutting project' was to final cutting the Japanese cedar forest and then plant saplings of low-pollen Japanese cedar cultivars to diminish the pollen in the environment and promote reforestation for the future. The goal was to cut the amount of pollen from Japanese cedars by 20 percent by clearcutting 1,200 ha of Japanese cedar forest and then planting saplings of low-pollen Japanese cedar cultivars (Tokyo Metropolitan, 2015).

The logs harvested within this framework were certified as 'Tama timber'. This certification system ensures that the logs were harvested from sustainably managed forests in the Tama region of Tokyo. This certification system began in 2006. The targets of certification are the target forests of the following programs: 'forest management plan', 'preventive measure of pollinosis', 'the reforestation project', 'the right to enjoy sunshine'. The conditions of certification are that the timber be harvested from a target forest and that all of the process of the distribution including its production and marketing, be performed by a certification logging contractors. Certified timber is accompanied by a paper, seal and stamp certifying the production area. (Tokyo Metropolitan Forestry Owners' Association Federation, 2012).

The implementation of this political measure was expected to affect local logging contractors considerably. Thus, in this study, changes in the logging systems of registered certified contractors as well as the timber distribution in the local market were investigated, and the effects of the measures on the local logging system and on timber productivity and distribution were examined.

## 2. METHODS

In this study, the 'Tama timber center' of the local market and registered certified contractors were investigated. The statistics on timber prices and handling volume of timber were investigated at the 'Tama timber center'. The target period is from 2006 to 2015. Also, the 'Tama timber center' is the only local market for registered certified contractors. Therefore, certification system of 'Tama timber' cannot be obtained unless it is shipped from this market. Thus, the 'Tama timber center' is an important base from which to clarify the trends in the certification systems of 'Tama timber' and 'preventive measure of pollinosis'. And a questionnaire was sent to 35 registered certified contractors regarding job performance, their logging system and whether they own high performance forestry machines, etc. Answers were obtained from 9 of these logging

contractors, for an answer of 26%.

### 3. RESULTS AND DISCUSSION

#### 3.1 Date analysis of ‘Tama timber center’

Fig. 1 shows the handling volume of the ‘Tama timber center’ and the percentage of ‘Tama timber’ in ‘Tama timber center’. The handling volume of the ‘Tama timber center’ was 8,904 m<sup>3</sup> in 2006. The handling volume after 2006 shows an incrementally increasing trend. The peak of the handling volume was 17,730 m<sup>3</sup> in 2012. The percentage of the ‘Tama timber’ in ‘Tama timber center’ was 22% in 2006. This percentage has increased in all years. The peak percentage of ‘Tama timber’ was 76% in 2015. Because this percentage is so high, many timbers handled at the ‘Tama timber center’ are circulated under the certification of ‘Tama timber’.

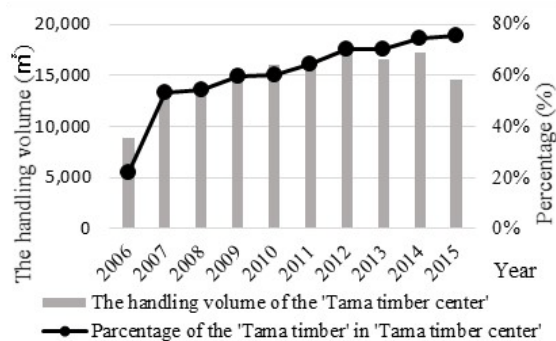

Fig.1 the handling volume of the ‘Tama timber center’ and the percentage of ‘Tama timber’ in ‘Tama timber center’

Fig. 2 shows the handling volume of and number of logging contractors for general timber and final cutting timber as a ‘preventive measure of pollinosis’. Final cutting timber as a ‘preventive measure of pollinosis’ was more handled than general timber in all years except 2006 and 2008. The volume of final cutting timber as a ‘preventive measure of pollinosis’ was 637 m<sup>3</sup> in 2006. The handling volume since the start the final cutting project as a ‘preventive measure of pollinosis’ was increase trend. After 2011, about 10,000 m<sup>3</sup> were handled per year. The handling volume of general timber showed a decreasing trend with a peak of 8,321 m<sup>3</sup> in 2006. In 2015, only 4,173 m<sup>3</sup> was handled. This handling volume was half that in 2006.

The number of logging contractors handling final cutting timber as a ‘preventive measure of pollinosis’ was 4 in 2006. After 2006 handled by number of logging contractors of same level in each years. Also, the number of general timber logging contractors showed a decreasing trend after a peak in 2006. The number of logging contractors handling general timber and the handling volume of general timber show the

same year-to-year trend in all years. The handling volume of general timber appears to have been greatly affected by the number of logging contractors available.

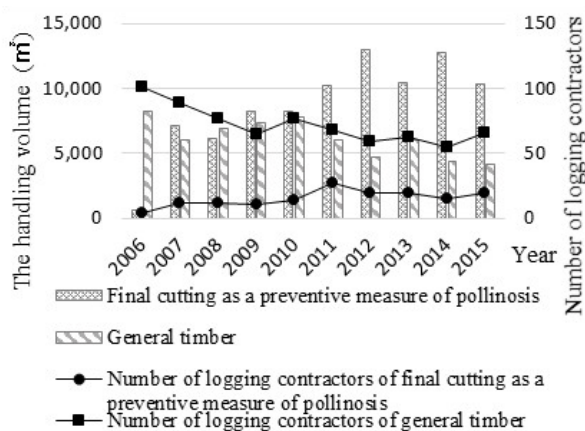

Fig.2 Handling volume of and number of logging contractors for general timber and final cutting timber as a ‘preventive measure of pollinosis’

Fig. 3 shows the average price of timber at ‘Tama timber center’, ‘Tama timber’ and final cutting timber as a ‘preventive measure of pollinosis’. The peak average price of timber at ‘Tama timber center’ was 14,938 yen/m<sup>3</sup> in 2006. After this, the average price of timber at ‘Tama timber center’ repetitively increased and decreased. Over the long term, however, it showed a decreasing trend. Also, trend of certification system of ‘Tama timber’ and final cutting timber as a ‘preventive measure of pollinosis’ tends to be the same as ‘Tama timber center’. But, these average prices are cheaper or same than the average price of ‘Tama timber center,’ it does not contribute to price improvement.

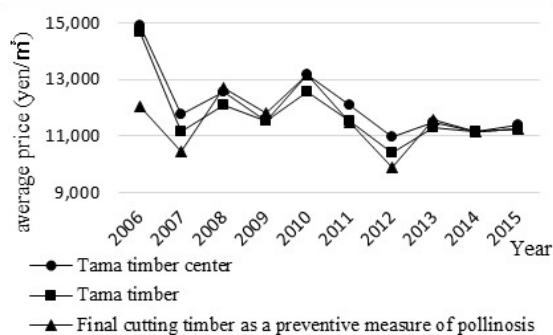

Fig.3 Average price of timber at ‘Tama timber center’, ‘Tama timber’ and final cutting timber as a ‘preventive measure of pollinosis’

The final cutting project as a ‘preventive measure of pollinosis’ and the certification system of ‘Tama timber’ have a big influence on the distribution system of the ‘Tama timber center’ and the Tama region of the Tokyo metropolitan area. However, this



timber price showed a decreasing trend. Therefore, logging contractor management remains difficult. Also, the log production volume of the final cutting project as a 'preventive measure of pollinosis' was increased after 2006. However, it is considered that the log production volume after the planning period of the project ended in 2015 has been decreasing. The 'Tama timber' volume appears to show the same trend. Thus, the final cutting project as a 'preventive measure of pollinosis' is considered to contribute to an increase in log production and to maintaining a steady supply of 'Tama timber'. As an initiative after planning period, it will be necessary to determine how to ensure a continued supply of 'Tama timber' and secure the log production volume.

### **3.2 Analysis of logging contractor questionnaire**

There are 7 logging contractors that participated in the certification system of 'Tama timber'. The 3 logging contractors took part in the final cutting project as a 'preventive measure of pollinosis'. The logging contractors were located as follows: 5 in Tokyo, 2 in Saitama, 1 in Yamanashi, and 1 in Yamagata.

There were 7 logging contractors that shipped to the 'Tama timber center'. There were 4 logging contractors shipped to markets other than the 'Tama timber center'. In addition, there were 2 logging contractors that shipped to sawmills in the Tokyo metropolitan area and chip factories outside the Tokyo metropolitan area. Also, there were 2 logging contractors that shipped to their own sawmills. Shipment to log markets outside the Tokyo metropolitan area was an answer given by logging contractors outside the Tokyo metropolitan area.

In the questionnaire results, 4 logging contractors answered that they had 'increased the number of machine that they owned' one reported the 'displacement of machines' and 4 reported 'that they owned no machine'. Also, one logging contractors that had reported 'that they owned no machine' answered that the harvest contractors owned the machines. Fig. 4 shows the number of high performance forestry machines owned by logging contractors. The numbers of grapples, processors, and forwarders owned has increased in the past 10 years. In particular, the number of grapples has increased significantly. Also, swing-yarders or harvesters were not owned in 2006 all were, purchased in the past 10 years.

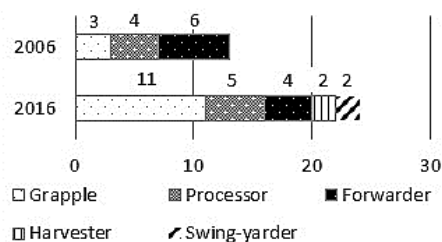

Fig.4 Ownership of high performance forestry machine

Fig. 5 shows the logging systems implemented by logging contractors. According to the questionnaire results, the final cutting project as a ‘preventive measure of pollinosis’ was carried out by 3 logging contractors. All 3 cases carried out the project using the cable type logging system. However, in 2 cases the logging contractors used the cable type logging system together with the wheel type logging system at the harvested site. Also, thinning was performed by 2 logging contractors and final cutting other than the final cutting as a ‘preventive measure of pollinosis’ was performed by 4 logging contractors.

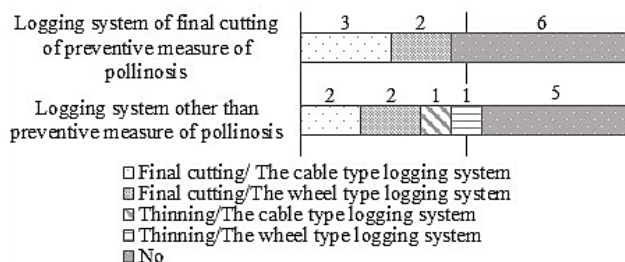

Fig.5 The logging systems implemented by logging contractors

Table.1 shows the questionnaire answers given regarding the influence of the ‘preventive measure of pollinosis’ and the certification system of ‘Tama timber’. Answers given about the certification system of ‘Tama timber’ included: ‘Tama timber’ is difficult to sell’, ‘revitalization of the market’, ‘decline in timber price’, and ‘increase in orders of ‘Tama timber’. Answers given regarding the final cutting as a ‘preventive measure of pollinosis’ increased: ‘increased log production’, ‘increased workers’, and ‘improved cable logging technology’. Influence on the Tama area included: were ‘Revitalization forestry activity in the Tama area’ and ‘Revitalization of mountain village’. However, one respondent asked whether it ‘will be possible to ‘regenerate the forest after the final cutting project as a preventive measure of pollinosis’.

Table.1 Answers regarding the influence of the preventive measure of pollinosis and the certification system of ‘Tama timber’

---

<b>Certification system of Tama timber (Tama timber center)</b>
<ul style="list-style-type: none"><li>• Difficult to sell other than Tama timber (other than area timber)</li><li>• The revitalization of the market due to the rise in handling volume. But, feel the timber price is falling</li><li>• Rise of orders of Tama timber for public works</li></ul>
<b>Final cutting as a preventive measure of pollinosis</b>
<ul style="list-style-type: none"><li>• Increase in log production    • Increases in workers    • Advancement of cable logging technology</li><li>• Can regenerate the forest after final cutting (lack of talent, mammal damage)</li></ul>
<b>Influence on the Tama area</b>
<ul style="list-style-type: none"><li>• Can continue sustainable forest management</li><li>• Revitalization of forestry activity in Tama area</li><li>• Revitalization of mountain village    • Promotion of forest improvement</li></ul>

---

Log contractors that carried out the final cutting as a ‘preventive measure of pollinosis’ used a cable type logging system. Also, there is no record of thinning being done during the project, only the final cutting. Therefore, it is considered that the final cutting as a ‘preventive measure of pollinosis’ influenced the logging system. Also, machine purchases were made after 2006 and final cutting by many logging contractors. Therefore, it is considered that many logging contractors in the Tama area were affected by project. Log production increased, the number of workers increased and advancement in techniques were all emerged on the questionnaire. According to WATAI *et al.*, productivity was increased by experience in the bucking process. Also, ISHIKAWA *et al.*, suggested that the advancement of the operators’ skills promoted improving the logging system. Thus, it is considered that final cutting as a ‘preventive measure of pollinosis’ helping improve productivity.

We can conclude, based on the questionnaire that the certification system of ‘Tama timber’ and the final cutting project as a ‘preventive measure of pollinosis’ influenced logging system and productivity. Forest maintenance was improved via the use of final cutting as a ‘preventive measure of pollinosis’, and forest activity in the Tama area increased. However, the outlook for log production in the Tama area after by the end of the ‘preventive measure of pollinosis’ is unknown. To maintain a steady supply of ‘Tama timber’ and to sustain local forestry activity, it is important to maintain production by promoting final cutting and improvements in productivity.

## REFERENCES

- Ishikawa, T., Tsujibata, T., Matsushita, A., Itaya, A., Hamamoto, K. and Tsujibata, T. (2008) “Operation analysis and improvement of logging system using high-performance forestry machines in mature forest.” *J. Jpn. For. Eng. Soc.*, 23(2),53-62 (in Japanese with English summary)
- Tokyo Metropolitan Forestry Owners’ Association Federation. (2012) “What is the certification system of ‘Tama Timber’ in Tokyo.” <http://www.toshinren.org/certification.html>. Accessed December 5, 2016. (in Japanese)\*
- Tokyo Metropolitan (2015) “Forest and forestry in Tokyo (Version 2015).” (<http://www.sangyo-rodo.metro.tokyo.jp/nourin/H27tokyoshinrin.pdf>). Accessed December 5, 2016. (in Japanese)\*
- Watai, J. and Sasaki, S. (2010) “Improvement in labor productivity of a logging operation by differences in skill level with a harvester and compatibility of the learning model in harvester work.” *Shizuoka Res. Inst. Of Agric. and For.*, 3, 51-55 (in Japanese with English summary).

\* The titles are approximate translations of the original Japanese titles by the authors of this paper

## P-06

### **Analyses on economic balances of clear cutting and regeneration operations in the northern area of Tochigi prefecture, Japan**

Kazuhiro Aruga<sup>1\*</sup>, Eri Akaguma<sup>1</sup>, Sachiho Fujimaki<sup>1</sup>, Takahisa Yamamoto<sup>1</sup> and Tomohiro Okuyama<sup>2</sup>

<sup>1</sup> Utsunomiya University, Faculty of Agriculture, Utsunomiya 321-8505, Japan.

<sup>2</sup> Nasu Forest Owners' Co-operative, Nasu 329-3445, Japan.

\*Corresponding author: Tel: +81 286495544 E-mail: [aruga@cc.utsunomiya-u.ac.jp](mailto:aruga@cc.utsunomiya-u.ac.jp)

**Abstract:** This study analyzed economic balances of clear cutting and regeneration operations with operators' daily reports and product sales reports of the Nasu Forest Owners' Cooperative in the Northern area of Tochigi prefecture, Japan. The productivities of clear cutting operations in 2013 and 2014 were 8.94 and 10.11 m<sup>3</sup>/person-day whereas those in the conventional and mechanized thinning operations were 3.09 and 5.14 m<sup>3</sup>/person-day. Total costs including direct and indirect costs of clear cutting operations in 2013 and 2014 were 50.25 and 62.32 USD/m<sup>3</sup> whereas those in the conventional and mechanized thinning operations were 106.82 and 75.29 USD/m<sup>3</sup>. These productivities and total costs were similar to the average values in Japan. Since profits of clear cutting operations in 2013 and 2014 were 15,205.94 and 20,804.40 USD/ha and regeneration costs including site preparation, planting, and weeding for 5 years were 17,773.44 and 17,825.62 USD/ha, the economic balance in 2013 was deficit. This is the typical situation of current Japanese forestry. Although regeneration operations were subsidized and economic balances with subsidies in 2013 and 2014 were profitable, 12,324.19 and 21,178.18 USD/ha, clear cutting and regeneration costs should be reduced for future budget reduction of subsidy.

**Keywords:** Revenue, Labor input, Productivity, Cost, Profit

#### **1. INTRODUCTION**

Japan's forest resources are mature enough for final felling operations. The share of planted forest area exceeding 50 years in age was 35% in 2007 and it is expected to exceed 60% by 2017. However, profit of final felling operations, USD 11,700.00/ha, did not cover reforestation expenses for the next decade (USD 15,600.00/ha) (Forestry Agency of Japan, 2013). Therefore, many forest owners are not willing to conduct final

felling operations and extending cutting age expected to increase revenues, owing to improvement of log prices, or unwilling to conduct regeneration operations even on unsuitable natural regeneration sites after final felling operations.

On the other hand, the Nasu Forest Owners' Cooperative in Tochigi Prefecture of Japan is willing to perform final felling operations because of less demand for large-diameter logs more than 40 cm in this area (Yano, 2013). In previous studies, the profitability of final felling operations have been examined (Mizuniwa et al., 2014; 2015; 2016); however, profitability of final felling operations including regeneration expenses has not been analyzed. Therefore, this study analyzed economic balances of clear cutting and regeneration operations with operators' daily reports and product sales reports of the Nasu Forest Owners' Cooperative in the Northern area of Tochigi prefecture, Japan.

## **2. MATERIALS AND METHODS**

The gross area of Nasu town is 37,231 ha, and the forest area is 23,654 ha (64% of the gross area). Investigations were made at seven thinning operation sites (Aruga et al., 2013) and nine final felling operation sites (Photo 1; Table 1). Thinning operations were conducted with a conventional operation system and a mechanized operation system whereas final felling operations were conducted with a mechanized operation system (Photos 2-5).

Strip road networks were established at a width of 2.0 m for the conventional operation system and 3.5 m for the mechanized operation system. Strip road networks were analyzed by considering density, average bunching distance, ratio of average bunching distance to its theoretical average, and average forwarding distance for thinning operations (Aruga et al. 2013) and clear cutting operations (Table 2).

Operational efficiency and direct operational expenses were estimated with operators' daily reports and product sales reports. Strip road establishment expenses, log transportation expenses, insurance costs, handling fees associated with the forest owners' cooperative and log markets, and piling fees at the log market were considered indirect operational expenses (Zenkoku Ringyo Kairyo Fukyu Kyokai 2001). In addition to the timber extraction expenses, regeneration costs including site preparation, planting, and weeding for 5 years were estimated on the basis of interviews with forest owners' cooperative officials.

Revenues were estimated using production volumes and unit prices from product sales reports. For regeneration and thinning operations, subsidies were received in Japan. Subsidies were estimated using standard unit costs, areas, assessment coefficients, and the subsidy rate of the Tochigi Prefectural Government (2011). For subsidized thinning

and regeneration operations in Japan, subsidies for strip road establishment were also received. In 2014, Tochigi Prefectural Government made additional subsidy to secure regeneration operations with 3,200.00 USD/ha, which was shortage of subsidy from Japanese government, when using completely felled trees as not only saw logs but also fuel woods.



Photo 1. Study site



Photo 2. Chainsaw felling



Photo 3. Grapple loader bunching



Photo 4. Processor bucking



Photo 5. Forwarder forwarding

Table 1. Study sites

	A	B	C	D	E	F	G	H	I
Species	Japanese cedar	Japanese cedar	Japanese cedar	Japanese cedar Japanese cypress	Japanese cedar	Japanese cedar	Japanese cedar	Japanese cedar Japanese cypress	Japanese cedar Japanese cypress
Harvest (year)	2013	2013	2013	2013	2014	2014	2014	2014	2014
Stand age (years)	49-55	41-70	43-61	44-59	59	67	50	47	50
Area (ha)	1.84	4.55	2.03	1.78	0.86	1.19	2.03	1.82	0.75
Slope angle (°)	22.47	24.40	9.78	21.55	19.77	29.85	15.48	24.32	4.76
Stand density (stem/ha)	1,050	1,240	1,400	900	569	984	576	848	1,887
Production volume (m <sup>3</sup> /stem)	0.54	0.26	0.44	0.41	1.00	0.60	0.74	0.44	0.38
Production volume (m <sup>3</sup> /ha)	565	328	611	371	566	590	429	370	709
Revenue (USD/m <sup>3</sup> )	79.84	85.07	86.46	95.03	105.74	105.91	107.79	103.13	97.48

Table 2. Strip road network analysis

	A	B	C	D	E	F	G	H	I
Density (m/ha)	323.30	357.62	389.01	354.20	410.97	294.44	477.47	429.23	240.19
Bunching distance (m)	10.86	8.06	11.44	8.91	9.57	12.42	7.40	6.80	14.36
Ratio of bunching distance*	1.40	1.15	1.78	1.26	1.57	1.46	1.41	1.17	1.38
Forwarding distance (m)	462.96	225.13	152.51	245.60	258.80	234.82	589.80	138.90	194.63

\*Ratio of average bunching distance to theoretical average bunching distance estimated using a rectangular model (theoretical average bunching distance = 2,500/road density)

### 3. RESULTS

The average productivity of felling operations in the clear cutting operations was increased from 9.56 m<sup>3</sup>/person-day in the thinning operations to 38.58 m<sup>3</sup>/person-day because no hung trees (Figure 1). The average productivity of bunching operations in the clear cutting operations were increased from 26.70 m<sup>3</sup>/person-day in the thinning operations to 41.01 m<sup>3</sup>/person-day because of no residual trees and shorter bunching distances with higher density of strip roads. The average productivity of processing operations in the clear cutting operations was similar to the thinning operations because processing operations were conducted on the strip roads in the mountainous areas and there were not enough spaces for processors to operate efficiently even in the clear cutting operations. The average productivity of forwarding operations in the clear cutting operations was increased from 30.17 m<sup>3</sup>/person-day in the thinning operations to 37.91 m<sup>3</sup>/person-day because of shorter forwarding distances with smaller stand areas ranging between 0.75 and 4.55 ha than aggregated stands to operate efficiently between 6.70 and 27.12 ha in the mechanized thinning operations (Aruga et al. 2013). The average productivities of felling, processing, bunching and forwarding operations were balanced in the clear cutting operations whereas the average productivity of processing operations was higher than other productivities in the mechanized thinning operations. Therefore, multiple chainsaw men, grapples, and forwarders were used in the stands to balance the productivity of each operation.



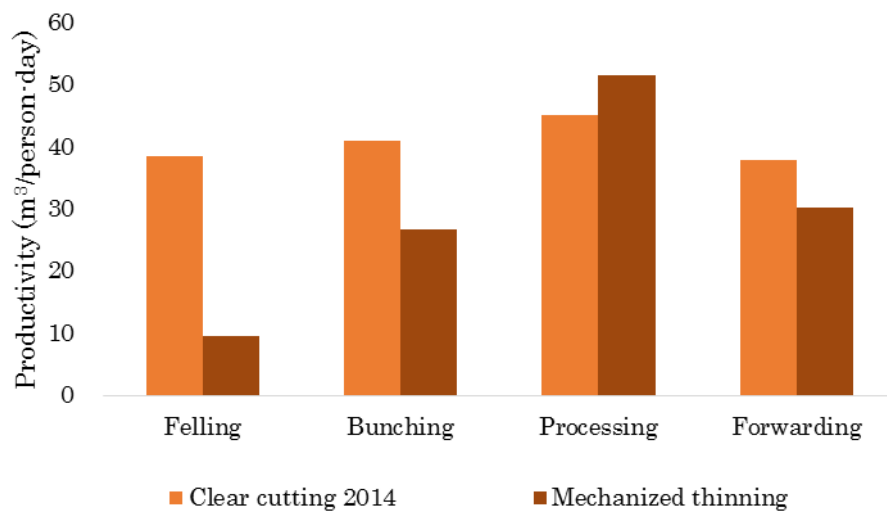

Figure 1. Productivity

The productivities of clear cutting operations in 2013 and 2014 were 8.94 and 10.11 m<sup>3</sup>/person-day whereas those in the conventional and mechanized thinning operations were 3.09 and 5.14 m<sup>3</sup>/person-day. Total costs including direct and indirect costs of clear cutting operations in 2013 and 2014 were 50.25 and 62.32 USD/m<sup>3</sup> whereas those in the conventional and mechanized thinning operations were 106.82 and 75.29 USD/m<sup>3</sup>. These productivities and total costs were similar to the average values in Japan. The revenues of clear cutting operations in 2013 and 2014 were 85.64 and 104.71 USD/m<sup>3</sup> whereas those in the conventional and mechanized thinning operations were 117.32 and 95.35 USD/m<sup>3</sup>. Therefore, profits of clear cutting operations were 35.39 and 42.49 USD/m<sup>3</sup> whereas those in the conventional and mechanized thinning operations were 10.49 and 20.06 USD/m<sup>3</sup>. Since profits of clear cutting operations in 2013 and 2014 were 15,205.94 and 20,804.40 USD/ha and regeneration costs including site preparation, planting, and weeding for 5 years were 17,773.44 and 17,825.62 USD/ha, the economic balance in 2013 was deficit. This is the typical situation of current Japanese forestry. Although regeneration operations were subsidized and economic balances with subsidies in 2013 and 2014 were profitable, 12,324.19 and 21,178.18 USD/ha (Figure 2), clear cutting and regeneration costs should be reduced for future budget reduction of subsidy.

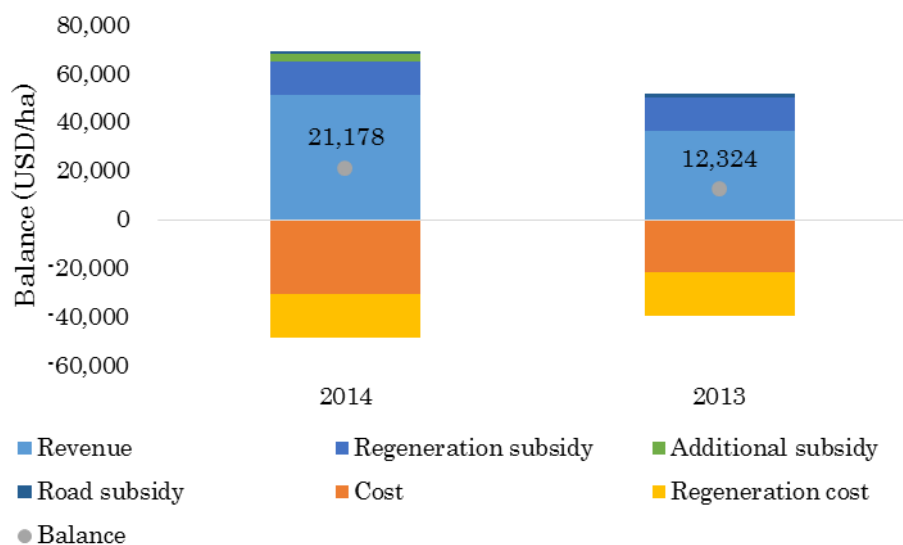

Figure 2. Balance

## ACKNOWLEDGEMENTS

We are grateful to the Nasu-machi Forest Owners' Cooperative for providing the research opportunities. This study was supported by JSPS KAKENHI grant number 15H04508.

## REFERENCES

- Aruga, K., Hiyamizu, G., Nakahata, C. and Saito, M., 2013. Effects of aggregating forests, establishing forest road networks, and mechanization on operational efficiency and costs in a mountainous region in Japan. *Journal of Forestry Research* 24: 747–754.
- Forestry Agency of Japan 2013. Annual Report on Forest and Forestry in Japan. Fiscal Year 2012 (summary). Forestry Agency of Japan, Tokyo.
- Mizuniwa, Y., Aruga, K., Nakahata, C. 2014. An analysis of the productivity and cost for clear cutting in Nasu-machi Forest Owners' Co-operative. *Kanto For Res* 65:197–200 (in Japanese with English summary).
- Mizuniwa, Y., Uemura, R., Aruga, K., Nakahata, C. 2015. Examining the profitability of clear-cutting operations in Nasu Forest Owners' Co-operative, Tochigi prefecture. *Bull Utsunomiya Univ For* 51:9–18 (in Japanese with English summary).
- Mizuniwa, Y., Nakahata, C., Aruga, K. 2016. Comparative analyses on the cycle time, productivity, and cost between commercial thinning and clear-cutting operations in Nasu-machi Forest Owners' Co-operative, Tochigi Prefecture, Japan. *J For Res* 21:99–104.
- Tochigi Prefectural Government, 2011. Forestation program standard unit cost table of

- fiscal year 2011. Tochigi Prefectural Government, Tochigi (in Japanese).
- Yano, K. 2013. Approach for the forestry revitalization of the Tochigi prefecture northern district. *J Jpn For Eng Soc* 28:59–65 (in Japanese).
- Zenkoku Ringyo Kairyo Fukyu Kyokai 2001. *Management of Forestry Mechanization*. Zenkoku Ringyo Kairyo Fukyu Kyokai, Tokyo (in Japanese).

**P-07**

**Productivity of Final Cutting in *Chamaecyparis obtusa* Dominated Shelterwood Stands  
-A Case of KANAZAWA YAMA National Forest-**

Mikiko Matsui<sup>1</sup>, Masashi Saito<sup>1,\*</sup>, Dai Otsuka<sup>2</sup>, Hiroki Matsunaga<sup>2</sup> and Tatsuhito Ueki<sup>1</sup>

<sup>1</sup> Faculty of Agriculture, Shinshu University, 8304Minamiminowa, Kamiina, Nagano 399-4598, Japan.

<sup>2</sup> Graduate school of Science and Technology, Shinshu University, 8304Minamiminowa, Kamiina, Nagano 399-4598, Japan.

\*Corresponding author: Tel: + 81- 0265-77-1652 E-mail: [m\\_saito@shinshu-u.ac.jp](mailto:m_saito@shinshu-u.ac.jp)

**Abstract:** Final cutting operations for shelterwood stands would take a lot of costs because felling operations should be conducted while protecting the lower tree unlike the clear-cutting operation. Since logging costs of final cutting operations for shelterwood stands in Japan are unclear, we observed the final cutting at the site different from the previous research on the habitat environment and working system in order to clarify the cost of final cutting. As a result, the productivity was 2.07 m<sup>3</sup>/ person day.

**Keywords:** Final cutting, Productivity, Logging cost, Shelterwood, *Chamaecyparis obtusa*

## 1. INTRODUCTION

In Japan, it is a problem that the timber price falls and it is impossible to pay the regeneration costs. Therefore, a shelterwood stands operation that induces natural regeneration has attracted attention. In particular, it is unnecessary to carry out renewal support work such as ground clearance in the multi storied forest management including shelterwood method of Japanese cypress forest, to over-weed and to carry out detailed care like artificial regeneration (Akai 1991), etc. have been clarified in previous studies. Therefore, it is thought that it is effective for cost reduction because it is expected to reduce the initial cost (Forestry Agency 2015) which accounts for about 70% of reeration costs. On the other hand, it is expected that the work efficiency will be lowered because it will be a logging operation in the state where the regeneration trees

exist. According to the survey conducted by Otsuka et.al (2016), the productivity is 6.26 m<sup>3</sup> / person day (including transport) and the main work cost is 2,657 yen / m<sup>3</sup>. However, there are few studies on the productivity of multi storied forest management such as shelterwood method. Therefore, the purpose of this research was to clarify the profitability of the shelterwood cutting stands from the observation result of the logging operation at the final cutting.

## 2. STUDY SITE

The investigation site is the Kanazawa National Forest 1408 forest compartment located in Chino City, Nagano Prefecture. Altitude 1180 m, slope 17.7 degrees, slope direction northeast, soil type B (d), forest floor growing moss.

This forest was planted in Hinoki cypress (*Chamaecyparis obtusa*) in 1933 and 20% thinning was done in 1975 and 1979. A number of seedlings occurred due to this influence, and in 1984, multi storied forest management was introduced. In 1984, the first thinning was done with a thinning rate of 64% and the second thinning with a thinning rate of 78% was done in 2005. Upper trees have the average tree height of 18.83m, the average tree diameter at breast height (DBH) of 39.66 cm, the average stem volume of 1.02m<sup>3</sup>, the stand density 131 trees/ha, the growing stock 140m<sup>3</sup>/ha. In addition, the average canopy length ratio is 71.1%, the average branch length in one direction is 3.6 m, the crown is large, and the average height-to-diameter ratio is 48.55%. The regeneration tree has an average tree height of 1.43 m and a standing tree density of 72,669 trees / ha (Table 1). In the plot before logging, 11,257 trees with a tree height of 0.2 m or more were confirmed (only living trees). The tree height of the regeneration tree is distributed from 20 cm or less to 10 m or more, and a dense multistage forest is formed.

Table 1. Status of stands

	Forest age (year)	Tree height (m)	DBH (cm)	Volume (m <sup>3</sup> /the tree)	Canopy length ratio (%)	Height to diameter ratio (%)	Stand density (trees/ha)	Grow stoc (m <sup>3</sup> /t)
Upper tree	83	18.83	39.66	1.02	71.1	48.5	131	140.
Lower tree	Unknown	1.43	-	-	-	-	72,669	-



Figure 1. Status of stands

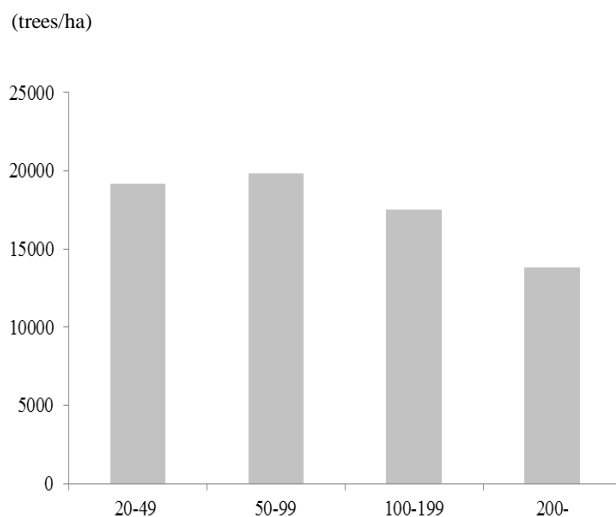

Figure 2. Distribution by rank

### 3. METHOD

The final cutting in the study site was conducted for two days on December 15 and 16, 2016. We estimated the cycle time for each step from time analysis by recording. Based on the results, the productivity was calculated and logging cost was calculated (National Forestry Improvement Promotion Association 2001). Felling and limbing was done with a chainsaw, yarding were collected directly with grapples ( $n = 7$ ), and timber in a range impossible to directly pick up were collected using 12 ton class base machine winches ( $n = 28$ ). All yarding at the winch were made only-stem. Bucking was done with a chainsaw while assisting with the grapple. Thereafter, Stacking was done with the grapple. As for transportation, it was not done during the investigation period and it was excluded from the analysis subject. Four people, who were responsible for felling, carried out these processes, limbing, bucking, grapple operation one by one. As soon as work on the process in charge was completed, a system was established to help other processes. At the time of calculating labor productivity, assuming parallel work, each element work was summed up in each process. Assume that the number of set persons is one in the felling, one in the limbing, two in the yarding, two in the bucking and one in the Stacking, total of 7 persons.

### 4. RESULT AND DISCUSSION

The productivity of each process was as follows. Felling is  $3.66\text{m}^3$  / hour, limbing is

3.92m<sup>3</sup> /hour, when the winch yarding is 1.86m<sup>3</sup> / hour, direct picking up timber is 3.88m<sup>3</sup> / hour, bucking is 1.59m<sup>3</sup> / hour, loading is 9.41m<sup>3</sup> / hour. In addition, the productivity was 2.37 m<sup>3</sup> / person day in the case of direct picking, 2.00m<sup>3</sup> / person day in the case of winch yarding, and on average 2.07m<sup>3</sup> / person day (Table 2). In the case of the preceding research, it was 9.49m<sup>3</sup> / person day (Otsuka 2016), and the productivity was significantly lower than that.

Looking at the breakdown of the cycle time, the ratio occupied by standby time is higher than 20%. In particular, the ratio occupied by this time is about 50% by bucking (Figure 3). This is expected to be the main factor of the decline in productivity. We harvested 35 target trees with a team of 4 people, which was an inefficient work that caused a lot of waiting time.

The operation system suitable for shelterwood method has not yet become clear. On this method, consideration about operation system is required.

On the other hand, the influence of the lower tree also appeared. In the process of felling, limbing, and yarding, the weeding of regeneration trees is included, and in cutting down, it accounts for about 20% of the total cycle time (Figure 4). This harvesting operation is rarely done in the precedent case. In the preceding case, the lower tree density was 10,904 trees / ha (Otsuka 2016), compared with 72,669 trees / ha in this study. From these facts, it is considered that the fact that the bottomed trees are dense is the cause of the weeding. When we didn't do enough mowing before felling, there was also a problem in which the upper trees was placed on lower tree and could not fall on the ground. In the case of not doing weeding, it takes time to select the felling direction, efficient yarding is difficult due to limited felling direction, changing the position where the wire is placed, the visibility is bad and the amount of movement is low. Increasing, such as high-density regeneration trees hindered work.

As a result, even when limbing or yarding, the regeneration trees that grow around them have become obstacles, and weeding has been done in the middle of the work. When weeding was not done enough before the felling, the problem occurred that logging trees were placed on multi storied forest and could not fall on the ground. From this, it turns out that the mowing before the logging was an inevitable task. In forests with high density regeneration tree, weeding is necessary, which work seems to be a factor in decreasing productivity.

Based on these results, the productivity was 2.07 m<sup>3</sup> / person day, and the main work cost was 10,913 yen / m<sup>3</sup>. Approximately 4 times the cost compared to 2,657 yen / m<sup>3</sup> of the precedent case (Otsuka 2016). In addition, the log selling price in the market is 18,324 yen / m<sup>3</sup>, which is slightly lower than 18400 yen / m<sup>3</sup> (Ministry of Agriculture, Forestry and Fisheries 2017), which is the nationwide average price of the Hinoki

cypress (*Chamaecyparis obtusa*) middle class log of the same period, It was significantly lower than the log selling price of 32,000 yen / m<sup>3</sup> (Otsuka 2016). Assuming that reduction of cost of reforestation is expected to be about the same as that of the preceding case example, the cost of reforestation were calculated to be 13,028 yen / m<sup>3</sup> (Nagano Prefecture Forestry Div.2015). Calculating the cutting cost, transportation cost, market cost combined with overhead cost. The result was that it could not be profitable (Table 3).

The cause of the low prices of woods is the trait of woods (Tapering, Heart rot). In addition, the growing stock in this case is 140 m<sup>3</sup>/ha, which is the half or less of the precedent example (Otsuka 2016). This is the cause of extremely low income at the final cutting. Therefore, on shelterwood method, consideration about cutting age and rate at removal cutting is required.

Table 2. Productivity per process

Operation	Machinery	Workers	Cycle number	Productivity (m <sup>3</sup> /hour)
Felling	Chainsaw	1	23	3.66
Limbing	Chainsaw	1	23	3.92
Yarding	Winch	2	20	1.86
	Grapple	2	3	3.88
Bucking	Chainsaw	2	23	1.59
Loading	Grapple	1	35	9.41
Productivity (m <sup>3</sup> /person day)				2.07

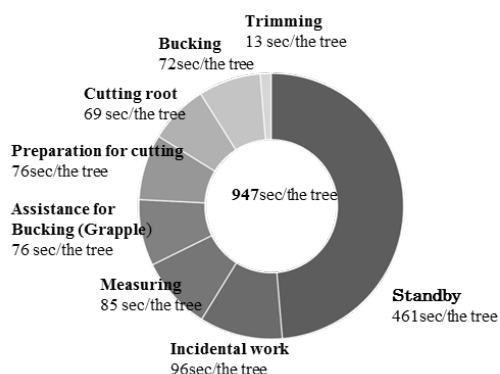

Figure 3. Cycle time of bucking

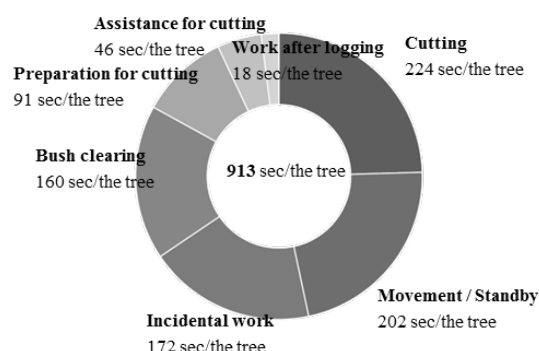

Figure 4. Cycle time of Felling



Table 3. Income and expenditure

Income (yen/m <sup>3</sup> )	18,324
Logging	16,105
Transport	3,281
Market	1,784
Reforestation	13,028
Difference	-15,874

### ACKNOWLEDGEMENT

This work was supported by JSPS KAKENHI Grant Number JP15H04508.

### REFERENCES

- Kawahara, T. (2001) "Fostering and managing diverse forests" TOKYO NODAI TEXTBOOK
- Akai, T. (1991) "Technical System of Extensive Afforestation—Laying Key Subject Natural of Hinoki (*Chamaecyparis obtusa*)" The reports of the Kyoto University Forests (21): 1~53.
- Forestry Agency (2015) "Annual Report on Forest and Forestry in Japan Fiscal Year 2015"
- Otuka, D., Saito, M., Morigutci, K., Ueki, T. (2016) "Productivity of vehicle logging system in final removal cutting -A case of Hinoki dominated shelterwood in Nagano Prefecture-" *J. Jpn. For. Eng. Soc.*, 31 (2): 79~83.
- Hyogo Prefectural Technology Center for Agriculture, Forestry and Fisheries (2008) "Towards the construction of low cost timber export system in Hyogo prefecture" Online: <http://hyogo-nourinsuisangc.jp/sinrin/images/p2006a.pdf> See May 25, 2017
- National Forestry Improvement Promotion Association (2001) "Mechanization management"
- Ministry of Agriculture (2017) "Wood price" Online: <http://www.maff.go.jp/j/tokei/kouhyou/mokuryu/kakaku/#r> See May 25, 2017
- Nagano Prefecture Forestry Div. (2015) "In order to grow a forest certainly after the clear cutting" Online: <http://www.pref.nagano.lg.jp/ringyo/kensei/soshiki/soshiki/kencho/shinshunoki/documents/reforestmanual.pdf> See May 25, 2017

## P-08

### The Tokyo Metropolitan Government Final Cutting Project

Mari Kawase<sup>1</sup>

<sup>1</sup>Department of Forest and Biomaterials Science, Graduate School of Agriculture, Kyoto University, Oiwake-cho, Kitashirakawa, Sakyo-ku, Kyoto 606-8502, Japan  
E-mail: [kawase.mari.75x@st.kyoto-u.ac.jp](mailto:kawase.mari.75x@st.kyoto-u.ac.jp)

**Abstract:** The aim of this study was to identify opportunities that would increase final-cutting activities in mountain forests near large cities such as Tokyo and Osaka. Interviews on this subject were conducted with individuals in charge of the forestry sections of the Tokyo Metropolitan Government, the Osaka Prefectural Government, and five prefectural governments around Osaka. We found that final cutting has been promoted in Tokyo since the fiscal year 2006. Comparisons among the governments indicated that final cutting should be financially supported by local governments for it to be increased. In Tokyo, allergies to *Cryptomeria japonica* pollen have been problematic and pollen reduction via final cutting is regarded as important, which has resulted in the establishment of public funds for final-cutting projects.

**Keywords:** Final cutting, *Cryptomeria japonica*, Interview, Tokyo, Policy

#### 1. INTRODUCTION

The high cost of logging has caused a reduction in the level of final-cutting activities in some mountain areas of Japan (note that final cutting is synonymous with clear cutting in this paper). The reduction in final-cutting activities has caused various problems such as losses to local forestry industries and biased stand-age structure. Tokyo has one of these low final-cutting mountain forests. The Tokyo Metropolitan Government has started promoting final cutting (Yoshidomi *et al.*, 2010). The purpose of this study was to understand the final-cutting project and compare it with perspectives of other prefectures to identify ways to increase final-cutting activities in mountain forests.

#### 2. METHODS

We used two methods in this study. First, we examined the final-cutting project of the Tokyo Metropolitan Government as follows. The author conducted interviews with three people in charge of the final-cutting project in 2010 and collected recent

information through the website of the Tokyo Metropolitan Government in 2017. The interviews were conducted with one person from the Bureau of Industrial and Labour Affairs and two people from the Tokyo Development Foundation for Agriculture, Forestry, and Fisheries. The following issues were discussed: 1) How the final cutting project started; 2) Project organization; and 3) Project achievements. Second, the author conducted an interview in 2010 with the person in charge of the forestry sections of the Osaka Prefecture. Osaka is located in the western part of Japan and was selected because it is similar to Tokyo in that it is urbanised and a low level of final-cutting activities. The author also conducted interviews in five prefectures around Osaka (Nara, Kyoto, Hyogo, Fukui, and Okayama) and collected opinions on the promotion of final-cutting activities, such as those undertaken by Tokyo.

### **3. RESULTS**

#### **3.1 Reasons for low levels of final cutting**

Before examining Tokyo's final cutting project, we gathered opinions from Osaka and the prefectures around Osaka to understand the reasons for the low levels of final-cutting activities. The main reasons presented were categorized into the following two categories: 1) Lack of revenue sources; interviews with Nara, Kyoto, and Osaka officials revealed that it was economically inappropriate to undertake final cutting and re-forest. In addition, Kyoto and Osaka were concerned about the burden on forest owners. 2) Deer damage; Kyoto officials mentioned that damage by deer would prevent young planted trees from growing.

#### **3.2 Justification for the final-cutting project in Tokyo**

This section describes the two reasons given for starting the final-cutting project in Tokyo in the fiscal year 2006. The first reason revolves around the increased pollen shed by plantation forests of *Cryptomeria japonica*. Many people suffer from pollen allergies. Tokyo assumed that thinning had only a temporary effect, of approximately two years, when it comes to reducing pollen and that final cutting was the only effective way to reduce pollen. The second reason is that approximately 90% of the forested area in Tokyo is over 40 years old (Bureau of Industrial and Labor Affairs, Tokyo Metropolitan Government, 2017). Tokyo assumed that the biased stand-age structure was unfavourable for biodiversity and CO<sub>2</sub> absorption and that final cutting of the plantation forest would reduce the stand-age structure. For these two reasons, Tokyo decided to begin its final cutting project. The final cutting project was carried out using public funds.

### 3.3 Project organization

The final cutting project was aimed at reducing pollen, and regenerating the forests, by conducting final cutting and reforestation with low-pollen<sup>1</sup> *Cryptomeria japonica* seedlings by the Tokyo Development Foundation for Agriculture, Forestry and Fisheries (TDFAFF<sup>2</sup>). TDFAFF would buy the  $\geq 30$ -year-old *Cryptomeria japonica* stumpage from forest owners, harvest, carry out and sell the timber and pay all expenses required for the planting and care for 20–30 years after planting. The timber harvested was transported to a log market known as the Tama timber centre (*Tama mokuzai center* in Japanese). The following section describes the duration, area, and budget for the project.

The implementation period of the final-cutting project was from fiscal years 2006 to 2015. The implementation areas were all private forests in the regional forest, except for the island of Tokyo, but included the forest in the Tama area (densely forested area in the western part of the Tokyo Metropolis), including Tokyo-owned forests. The forests to be cut were  $\geq 30$ -years-of-age because Tokyo assumed that this age of *Cryptomeria japonica* produced the largest amount of pollen. About 2.5 billion yen was established as a budget for fiscal 2006. The timber sales margin of the final cutting project and donations were put into a fund. According to the proceedings of the Tokyo Metropolitan Assembly, this project finished in fiscal year 2014, and the renewed project started in fiscal year 2015.

The following measures were taken by TDFAFF to promote the project. TDFAFF sent newsletters describing the status of the project site to the owners by mail. The newsletters asked the owners for changes in address and any other updates. TDFAFF started publishing an annual newsletter in October 2008, which contained the achievements of the project, information on harvesting and carrying out timber, how the timber was used, etc. TDFAFF consulted with owners about forest damage caused by disease, wildlife and insects.

The following two problems prevented the project from being conducted in some areas. First, there was consistent deer damage. Final cutting was not conducted if deer damage was severe. Second, the high cost of carrying out timber is often prohibitive. Final cutting could not be conducted in cases where the cost of carrying out timber from forests far from the road system was too great.

---

<sup>1</sup> The pollen count of low-pollen varieties is less than that of varieties with normal pollen production.

<sup>2</sup> TDFAFF is an abbreviation created by the author of this paper.

### 3.4 Project achievements

The Bureau of Industrial and Labour Affairs, Tokyo Metropolitan Government (2017), showed that the reforestation area of private forests in Tokyo were supported with a budget<sup>3</sup>; from fiscal years 1960 to 2015, the lowest area was only 4 ha in 2003 and, after 2003, the highest was 78 ha in 2013. Before the project, final cutting and reforestation activities had been decreasing. As shown above, reforestation activities increased after the final cutting project started.

The achievements of the project are divided into three aspects. First, the project marked the beginning of pollen reduction; in fact, policies to reduce pollen through final cutting were first started in Japan. *Cryptomeria japonica* stands  $\geq 30$  years were harvested, although the level of pollen reduction has not been quantitatively demonstrated. Second, a younger stand-age structure was developed. Final cutting transitioned the older stand-age structure to a younger, more vital structure, which is favourable in terms of biodiversity and CO<sub>2</sub> absorption. Third, the project cancelled profit-sharing plantation contracts and determined the boundaries of owned forests. The project promoted the cancellation of the profit-sharing plantation contracts because the owners profited from the project, although the profit was limited. The project also contributed to determining the boundaries of owned forests.

## 4. DISCUSSION

Yoshidomi *et al.* (2010) interviewed local loggers and reported the influence of the final-cutting project on local timber markets in Tokyo; our study examines options for increasing final-cutting activities. This section compares prefectural governments' attitudes toward final cutting. Among the interviewed governments, only Tokyo promoted the final-cutting project. The situations differed among the prefectures, but it is reasonable to suppose that Tokyo had reasons for increasing their final-cutting activities.

Both in Tokyo and in the other prefectures, final-cutting promotion, given the depression of the local forestry industries, needed financial support. In Tokyo, the social demand for pollen reduction resulted in the establishment of a 2.5 billion-yen budget. It was estimated that 28.2% of people in Tokyo had a pollen allergy in 2006 (Bureau of Social Welfare and Public Health, Tokyo Metropolitan Government, 2009).

Public funds enable forest owners to be freed from the burden of final cutting and re-forestation. The project has been evaluated highly in that final-cutting activities have increased. In addition, this project has solved several problems at the local forestry level,

---

<sup>3</sup> This budget is not only for the final-cutting project but also for other projects.

such as the determination of boundaries of owned forests.

## 5. CONCLUSIONS

This study examined the final-cutting project of the Tokyo Metropolitan Government so as to find ways to increase final-cutting activities in mountain forests. Comparisons between Tokyo and other prefectures indicated that one of these solutions might be financial support for final cutting. Since final cutting is an activity that takes place on the private property of forest owners, public subsidies for final cutting need careful discussion. Tokyo's project suggests that too much pollen production and a biased stand-age forest structure are the keys to justifying such public subsidies.

## ACKNOWLEDGEMENT

The author would like to thank all of the government officials who kindly agreed to be interviewed.

## REFERENCES

- Bureau of Industrial and Labor Affairs, Tokyo Metropolitan Government (2017) *Tokyo no shinrin ringyou (heisei 28 nen ban) [Forest and forestry in Tokyo in 2016 year\*]*, Tokyo Metropolitan Government (in Japanese).
- Bureau of Social Welfare and Public Health, Tokyo Metropolitan Government (2009) *Kafunsho hitokuchi memo [A short memo on pollen allergy in fiscal year 2009\*]*, Tokyo Metropolitan Government (in Japanese).
- Tokyo Metropolitan Assembly (<https://www.gikai.metro.tokyo.jp/record>, 2016/01/24)
- Tokyo Metropolitan Government (<http://www.metro.tokyo.jp/>, 2016/12/07).
- Yoshidomi, R., Sugiura, K. Yoshioka, T. and Inoue, K. (2010) "Effects of final cutting as a preventive measure of pollinosis on the trade of logs originated from Tama region and the regional forestry." *J. Jpn. For. Eng. Soc.*, 25(2), 103-110 (in Japanese).

\* The English titles are tentative translations by the author of this paper from original Japanese titles.

## P-09

### **Factor of Illegal Logging through Villagers Perspectives: A Case Study in Permanent Reserve Forest Ulu Sat, Kelantan, Peninsular Malaysia**

Nur Afifah Mohamad Amran<sup>\*1</sup>, Pakhriazad Hassan Zaki<sup>1</sup>, Mohd Hasmadi Ismail<sup>2</sup>, Wan Nur Farinie Wan Zee<sup>1</sup>, Nur Syuhada Nawi<sup>1</sup>, Md. Damiri Md. Sairi<sup>1</sup> and Nor Azmi Baharom<sup>1</sup>

<sup>1</sup>Department of Forest Management, Faculty of Forestry, Universiti Putra Malaysia

<sup>2</sup>Department of Forest Production, Faculty of Forestry, Universiti Putra Malaysia

\*Corresponding author: Tel: +6013-3003217 Email: [nur\\_afifah2703@yahoo.com](mailto:nur_afifah2703@yahoo.com)

**Abstract:** Illegal logging is the main issue in Permanent Reserve Forest (PRF) Ulu Sat. The objectives of this study were to identify the factor that caused the illegal logging in PRF from the local community perspectives. This study were conducted in the state of Kelantan, which is one of the states in Peninsular Malaysia with the largest forest reserve and experiencing problems of illegal logging activities. About 400 respondents were randomly selected through sampling method. Data collected were analyzed by using the “Statistical Package for the Social Science” (SPSS version 22.0). The act of illegal logging in PRF can be better understood if the studies be expanded among the other states in Malaysia.

**Keywords:** Illegal logging, Villagers, Permanent Reserve Forest

#### **1. INTRODUCTION**

Logging is a major source of revenue that generated from Permanent Reserve Forest (PRF), in the State of Kelantan. Due to the availability quality of logs in PRF, State of Kelantan, cause the widespread of the illegal logging. There are many factor that contribute to the occurrence of illegal logging activity such as incompetent and inconsistent government policies in management due to the lack of knowledge that are related to the forest policies (Callister, 1999; Morozov, 2000; Contreras-Hermosilla, 2002). Illegal logging is felling and extraction of logs from forest without official license (Mir and Fraser, 2003). This occurs due to the forest management plans that are inconsistent with the official license that have been issued by Forestry Development based on the current forestry law. Apart from that, it also represents a global concern because it has caused losses between \$10 and \$15 billion in the tropics and \$1 billion in

the United States alone in developing and developed economies is a global concern (World Bank, 2002; Mendoza, 2003; Johnson, 2003) and become an important issue in the global policy to sustainable forest management.

Logging can be classified as 'illegal' when logging activities operates outside the boundaries of concession areas. Illegal logging also can be characterized by a variety of activities such as the nature of the operator (Callister, 1999) and occur outside the forest like illegal timber transport and processing (Day, 1998). Furthermore, particularly in developing nations, illegal logging can be legal harvesting (Greenpeace, 2008; WWF, 2002, 2004). The harvesting of logs in contravention of laws and regulations to prevent the overexploitation of forest resources and to promote sustainable forest management (ITTO, 2001). Its include logging in protected areas, species, outside concession boundaries, extraction of more than allowable harvest, removal of oversized or undersized trees and harvesting in areas extraction is prohibited (Callister, 1992). Illegal logging is a part of the illegal activities in the forest sector such as timber processing, trade of wood and wood product illegally (Bouriaud and Niskanen, 2003). According FLEGT, 2002, illegal logging can be defined as logging activities that violates the prescriptions of law in the timber-producer in countries. Illegal logging also can be classified in two categories of law violation likes "timber robbery"(such as timber theft and stolen timber) and "unauthorized logging" (logging without a felling license, logging against or above the prescriptions of the forest management plan and logging in the area were cuttings are prohibited).

## **2. MATERIAL AND METHODS**

### **2.1 Study Area**

The study area is around the village at Permanent Reserve Forest Ulu Sat, Kelantan, Peninsular Malaysia (Figure 1). Permanent Reserve Forest Ulu Sat covering area of 14,432 hectares and at the district of Kelantan East (Kelantan State Forestry Department, 2014). The study site lies between latitude 5.7632373 and longitude 102.2167786. The district of Ulu Sat have 12 sub-districts which include 69 villages.



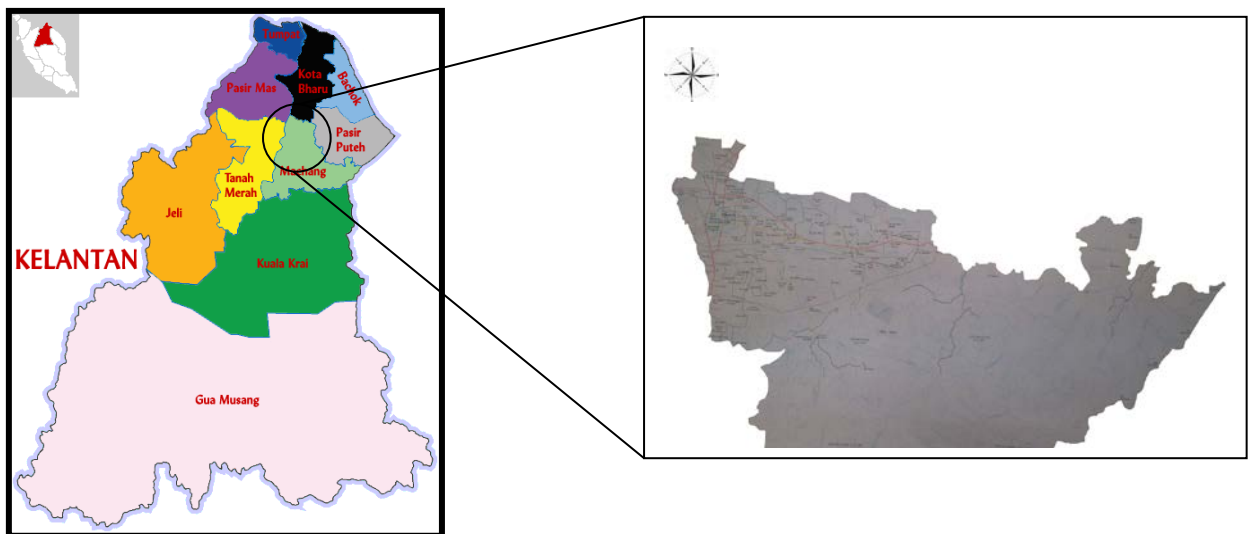
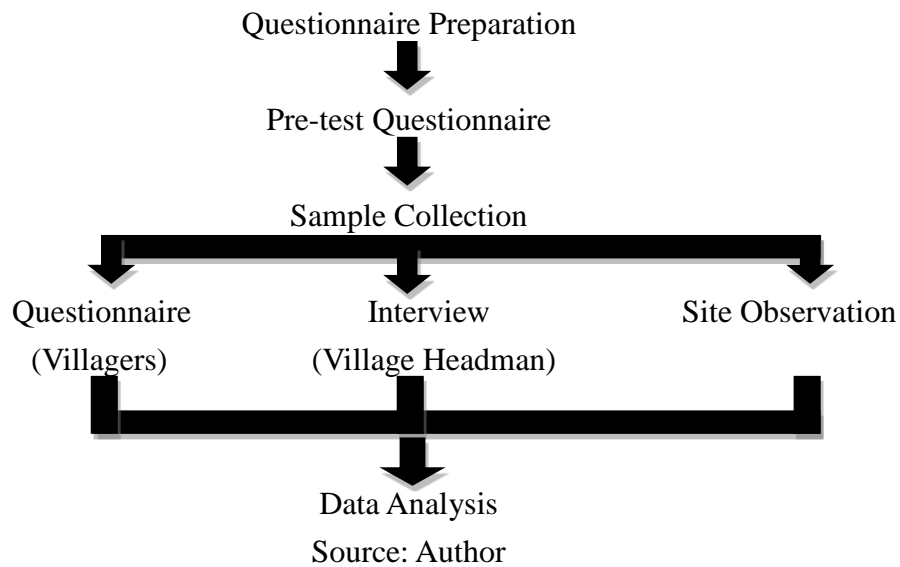

Figure 1: Map of PRF Ulu Sat

Source: Department of Survey and Mapping, Malaysia 2007.

## 2.2 Data Preparation

This research that involve 400 people consists of the male and female as a targeted respondents the villagers around the Permanent Reserve Forest Ulu Sat that involved or have knowledge about the illegal logging activity. The respondents randomly selected based on the population in these sub-districts and respondent's aged from 21 until 60 years that individual can understand questions and answer fairly based on the questionnaire. Besides that, data collected performed by using questionnaire, interview and site observation. The pre-testing questionnaires were conducted in March, 2017 for necessary modification. Data were collected in the April, 2017. The questionnaire based on villager's opinions and views about the factors of the illegal logging that happened around their village.



### 3. RESULTS

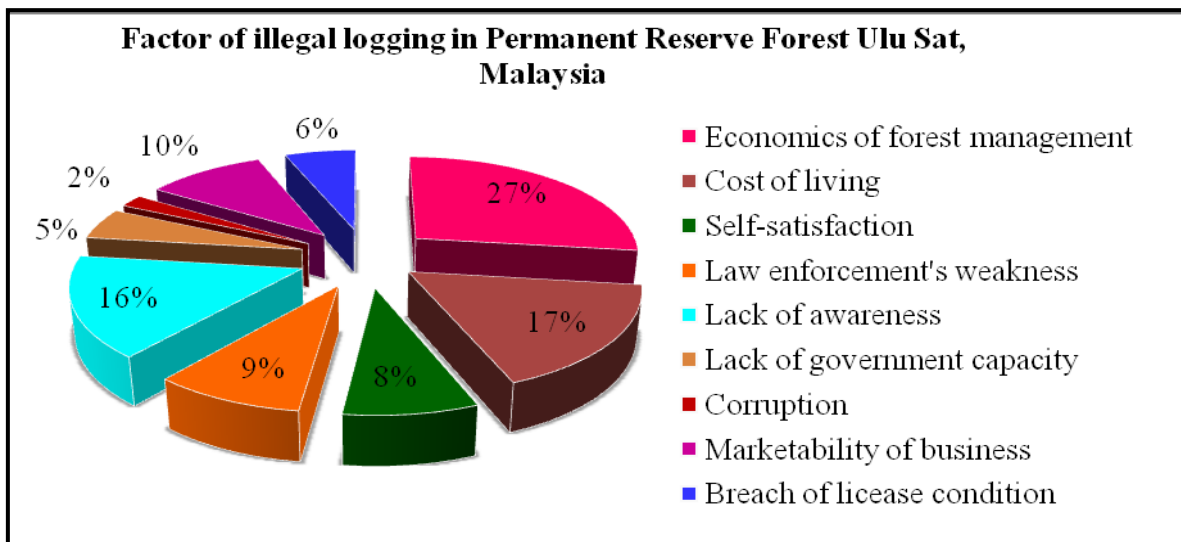

The highest factor of illegal logging in PRF Ulu Sat is because of the economic of forest management. It was happened due to the amount of fines imposed on the offense committing illegal logging are low. The illegal loggers are willing to pay the fines imposed since the income generated from the sale of such product were higher. The states also consider the benefits of economic and costs in their decision-making of the related to the both national and international issues (Hempel, 1996). While the lowest factor of the occurrence of illegal logging is corruption. According to Callister (1999); Newel et al (2000); Scotland (2000); Siebert (2001); and Global Witness (2004), they concluded that based on the number of source have noted that the relationship between corruption and illegal logging must be given the attention it deserves because it is intertwined.

#### 4. DISCUSSION

Illegal logging occurs in the study area due to the lack of information that relayed to the Kelantan State Forestry Department to conduct raids to curb the illegal activity. This situation is proven because there are some villagers that also were involved either directly or indirectly in the illegal logging activities. There are three factors that contributed to rampant corruption in the forest sector (Contreras-Hermosilla, 2002). First, the government adopted many legislation aimed to achieved the better utilization of forest sector. Second, forest are distant from the centers of decision-making (Forestry Department) provides an opportunity to the field officer have spacious discretionary authority and opportunities for corrupt behavior. Third, government officials have relatively low salaries that contribute to the corruption. To address this problem, Kelantan State Forestry Department must conducting camps, exhibitions or programs to provide initial exposure to the villagers about forest offences often committed by the concessionaires and the compound or any fines that will be imposed on the individuals that involved in the illegal activities in the PRF.

#### REFERENCES

- Bouriaud, L. and Niskanen, A. (2003) 'Illegal removals in the context of the sound use of wood', paper presented to the International symposium on Strategies for the Sound Use of Wood, UNECE Timber Committee, 24-27 March, Poiana Brasov, Romania.
- Callister, D.J. (1992) *"Illegal Tropical Timber Trade: Asia-Pacific"*. TRAFFIC International, Cambridge.
- Callister, D.J. (1999) *"Corrupt and Illegal Activities in the Forestry Sector: Current understandings and implications for World Bank Forest Policy"*, Forest Policy Implementation Review and Strategy Development: Analytical Studies. World Bank Group.
- Contreras -Hermosilla, A. (2002) "Illegal Forest Production and Trade. An overview".
- Contreras-Hermosilla, A. (2002) "Law compliance in the forestry sector: An overview". WBI Working Paper, Washington, DC, World Bank.
- Day, B. (1998) *"Who's Collecting the Rent? Taxation and Superprofits in the Forest Sector"*, Environment Department Working Paper. CSERGE, London.
- Greenpeace (2008) "Illegal logging – destroying the last Ancient Forest [online]".
- Global Witness (2004) "Taking a Cut: Institutionalised Corruption and Illegal Logging in Cambodia's Aural Wildlife Sanctuary." London, Global Witness.
- Hempel, L. (1996) "Environmental Governance: The Global Challenge," Washington,

- DC, Island Press.
- ITTO (2001) “*Strengthening sustainable forest management in Indonesia.*” Report submitted to the International Tropical Timber Council by the mission established pursuant to decision 12 (XXIX). Thirty-first session, October 29 –November 3, Yokohama, Japan.
- Kelantan State Forestry Department (2014) “Annual Report 2014. Kelantan State Forestry Department.” p.26.
- Johnson, S. (2003) “Estimating the extent of illegal trade of tropical forest products.” *International Forestry Review* 5 (3), 247-252.
- Mendoza, M. (2003) “Thieves in the forest: felling America’s trees.” *The Miami Herald International Edition*. May 18.
- Mir, J., Fraser, A. (2003) “Illegal logging in the Asia-Pacific region: an ADB perspective.” *International Forestry Review* 5 (3), 278-281.
- Morozov, A. (2000) “Survey of illegal forest felling activities in Russia (forms and methods of illegal cuttings).” pp.14. [www.forest.ru/eng/publications/illegal/](http://www.forest.ru/eng/publications/illegal/) [accessed December 2002].
- Newell, J., Lebedev, A. and Gordon, D. (2000) “Plundering Russia’s Far Eastern Taiga: Illegal Logging Corruption and Trade,” Vladivostok, Bureau for Regional Oriental Campaign, Friends of The Earth Japan and Pacific Environment and Resources Center.
- Scotland, N. (2000) “Indonesia Country Paper on Illegal Logging, Jakarta,” Department for International Development.
- Siebert, U. (2001) “Benin’s Forest Corruption.” Berlin, Free University of Berlin. Department of Social Anthropology.
- World Bank (2002) “A Revised Forest Strategy for the World Bank Group.” World Bank, Washington DC, USA.
- WWF [World Wildlife Fund] (2002) “Illegal logging in the southern part of the Russian Far East”. (pp.18). Moscow World Wildlife Fund.
- WWF [World Wildlife Fund] (2004) “Failing the forests.” Europe’s Illegal Timber Trade. pp.97. Surrey World Wildlife Fund.

## P-10

### Long-term Wood Supply Planning using Precise Forest Information

Hisashi Hasegawa <sup>1,\*</sup>, Hiroaki Shirasawa <sup>2</sup>, Hiroyuki Okada <sup>3</sup>, Hideaki Suzuki <sup>3</sup>,  
Seiichiro Sakaguchi <sup>3</sup> and Takao Nakane <sup>4</sup>

<sup>1</sup> Wakayama Forest Research Station, Field Science Education and Research Center,  
Kyoto University, 76 Kamiyukawa, Aridagawa-cho, Arida-gun, Wakayama 643-0551,  
Japan.

<sup>2</sup> Education and Research Center of Alpine Field Science, Shinshu University, 8304  
Minami-Minowa-mura, Kamiina-gun, Nagano 399-4598, Japan

<sup>3</sup> Sumitomo Forestry Co., Ltd., Keidanren Kaikan, 3-2, Otemachi 1-chome, Chiyoda-ku,  
Tokyo 100-8270, Japan

<sup>4</sup> Photec Co., Ltd., 2-37, North36 East26, Higashi-ku, Sapporo-shi, Hokkaido, JAPAN

\*Corresponding author: Tel: + 81-737-23-7742 E-mail: [hase@kais.kyoto-u.ac.jp](mailto:hase@kais.kyoto-u.ac.jp)

**Abstract:** In Japan, trees planted at the period of high economic growth (1954-1973) are enough to be harvested, and the Japanese Government is promoting final cutting and reforestation. However, wood demand and supply are lacking coordination because these plantation stands aimed to produce housing studs in spite that the number of housing starts are decreasing in these decades. In additionally, difficulty of precise estimation of harvesting volume complicates adjustment of supply and demand. In this study, we tried to estimate wood supply ability considering practical harvesting methods by using aerial photographs, LiDAR, and the other documents. We also produced annual wood supply plans for 40 years at a certain stand management schedule, and predicted a transition of stand conditions (distribution of age classes, density, volume, DBH, height, and relative yield index) by using a stand growth model.

**Keywords:** LiDAR, GIS, Logging possibility, Road network, Stand growth

#### 1. INTRODUCTION

In Japan, trees planted at the period of high economic growth (1954-1973) are enough to be harvested, and the Japanese Government is promoting final cutting and reforestation. However, wood demand and supply are lacking coordination because these plantation stands aimed to produce housing studs in spite that the number of housing starts are decreasing in these decades. In addition, difficulty of precise

estimation of harvesting volume complicates adjustment of supply and demand. For example, estimated harvesting volume is short because a yarding machine cannot approach a part of harvesting planned sites, or because yield by weight is lower than estimate for low wood quality. Low accuracy of estimate in harvesting volume causes decrease of price bargaining power at wood seller, and make stable and long-term wood supply difficult. There is a risk of forest resources degradation by promotion of final cutting without precise and flexible long-term harvesting plans.

In this study, we tried to estimate wood supply ability considering practical harvesting methods by using aerial photographs, LiDAR, and the other documents. Although there are many previous studies about forest inventory using LiDAR (Hyypä *et al.*, 2009), only a few studies consider harvesting methods.

We also produced annual wood supply plans for 40 years at a certain stand management schedule, and predicted a transition of stand conditions (distribution of age classes, density, volume, DBH, height, and relative yield index) by using a stand growth model. Although, in this area, some wood supply planning methods using decision support system have already developed (MacLean *et al.*, 2001), only a few studies estimate both harvesting volume and change of stand conditions practically.

## 2. METHODS

### 2.1 Estimation of wood supply ability

Study site is located in Maniwa City, Okayama Prefecture, Japan. Plantation stands consist of 1073.9 ha of Japanese cedar (*Cryptomeria japonica*) and 1820.0 ha of Hinoki cypress (*Chamaecyparis obtusa*), and total plantation area is 2893.9 ha. In this area, we divided forest type data (including species) by aerial photograph, and estimated stand information as follows: Stand density, counted tree top points produced from LiDAR

; Stand height, averaged counted tree top points

; DBH, calculated from a regression model of actual measured DBH and tree height estimated by LiDAR

; Site quality class, calculated as stand height at 40 years old from a regression model of stand height and stand age

; Stand slope, calculated from LiDAR

; Stand age, overlaid with forest register data and distributed as areas.

Plantation area is divided into 10,444 stands, and stand size is  $0.277 \pm 0.864$  ha (mean  $\pm$  SD); stand age is  $51.5 \pm 15.6$  years old; DBH is  $26.6 \pm 5.2$  cm; stand height is  $20.1 \pm 4.3$  m; stand density is  $882 \pm 268$  trees / ha.

We also prepared road data in this area from a map issued by the geographical Survey Institute in Japan (GSI) and photographic interpretation. Identified road length

was 488.0 km. In addition, we use land use data from the map of GSI.

In estimation of wood supply ability, utilizing winch, swing yarder, and tower yarder was assumed. Condition of applying yarding methods was defined as Table 1.

We judged appropriate yarding method in each stand using road data and microtopography produced by LiDAR. In the judgement, the applicable area of the winch yarding was simply set as 40 m from roads (buffer), while those of swing yarder and tower yarder were computed cable availability from a point of any forest roads without interruption by terrain. Cable lines cannot pass over any buildings and firms. Assumed specs of cable system are shown in Table 2.

Table 1. Condition of applying yarding methods

Yarding methods	Maximum yarding distance (m)	Minimum yarding volume(m <sup>3</sup> / line)	Applicable road type
Winch	40	–	Forwarder ※1
Swing yarder	100	20	Forwarder ※1
Tower Yarder※2	500	150	10t truck

※1 : Transportation distance is up to 1,000m; ※2 : Cut slope height is up to 9m in uphill yarding

Table 2. Assumed specs of cable system

	Swing yarder	Tower yarder
Headtree height (m)	8	11
Tailtree height (m)	7	7
Cable weight (kN/m)	0.015	0.015
Cable tension (kN)	20	40
Carriage weight (kN)	10	10
Minimum clearance (m)	3	6
Maximum span (m)	100	500
Minimum span (m)	20	100
Cable support	not available	available
Cable support height (m)	-	7

## 2.2 Wood supply planning and transition of stand condition

Plantation management plan was set as Table 3. Harvesting (thinning and final cutting)

area and volume were calculated in accordance with the management plan considering stand growth. Formula in LYCS 3.3 (Shiraishi, 1986) was applied as the stand growth model. Yarding in thinning and final cutting would be carried out only in stands judged as harvesting available area in the analysis of wood supply ability. We produced annual wood supply plans for 40 years at each stand, and predicted a transition of stand conditions (distribution of age classes, density, volume, DBH, height, and relative yield index) for 100 years by using MATLAB R2015b.

Table 3. Plantation management plan

No.	Species	Management type	Rotation age (years)	Planting density (trees / ha)	First thinning (year)	Utilization thinning (year)	Area (ha)
1	Cedar	Short	50	3000	15	25,33,40	105.25
2	Cedar	Medium	65	3000	15	30,40,50	696.72
3	Cedar	Long	80	3000	15	30,45,60,	271.88
4	Cypress	Short	60	3000	15	25,35,45	181.08
5	Cypress	Medium	80	3000	15	30,45,60	1211.73
5	Cypress	Long	120	3000	15	35,50,80	427.22

### 3. RESULTS AND DISCUSSION

#### 3.1 Comparison between existing forest register data and estimated data

Figure 1 and Figure 2 show examples of the difference in stand compartment and stand volume between existing forest register data and newly produced data estimated by LiDAR and other precise information, respectively.

Existing data is inaccurate both in the shape and volume. Particularly, existing data has a tendency of lower volume than the precise data. Comparison with true value is one of the important future works.



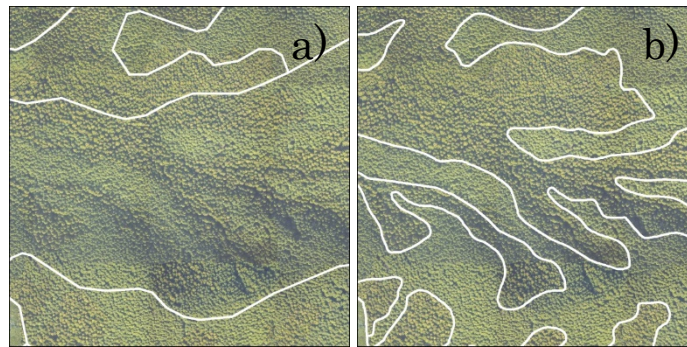

Figure 1. Existing and produced compartment. a) existing forest register, b) newly produced data estimated by LiDAR and other precise information

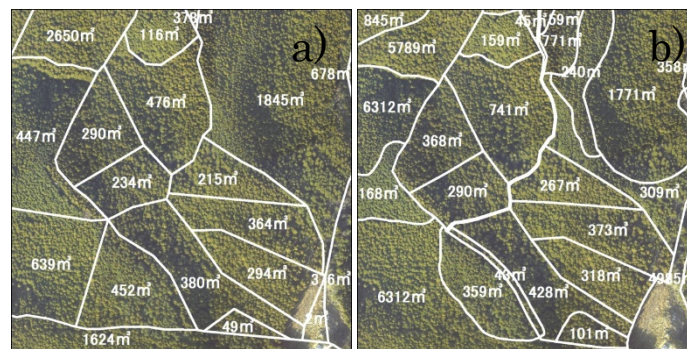

Figure 2. Existing and produced stand volume. a) existing forest register, b) newly produced data estimated by LiDAR and other precise information

### 3.2 Wood supply ability

Figure 3 shows analyzed area (2893.9 ha) and harvestable area (1633.8 ha). Harvesting is not available in 43.5 % due to terrain (1,014.0ha) and land use (246.1 ha). Selected yarding system was winch yarding 1,075.7 ha, swing yarder 477.1 ha, tower yarder 81.0 ha.

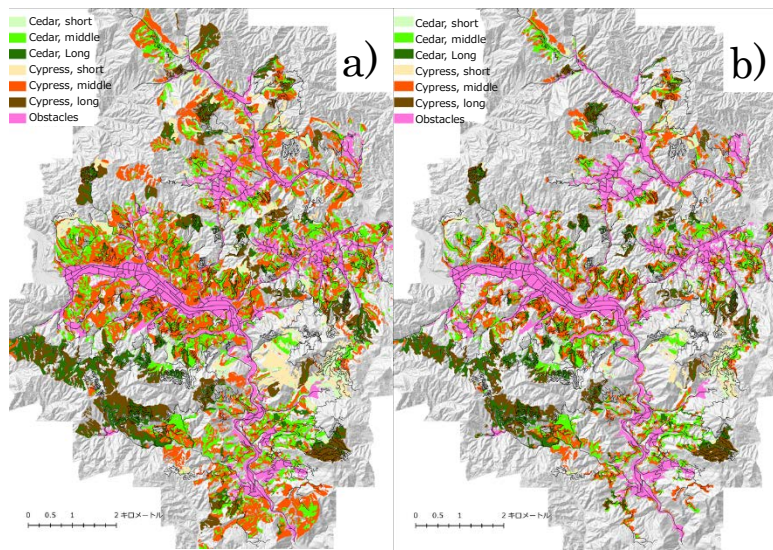

Figure 3. Analyzed stands and utilizable stands. a) analysis target area (2893.9 ha), b) harvestable area by winch, swing yarder, or tower yarder (1633.8 ha)

### 3.3 Wood supply planning

Examples of operation stands in each 5 fiscal years is shown in Figure 4, and total operational area and volume in each 5 fiscal years are shown in Figure 5.

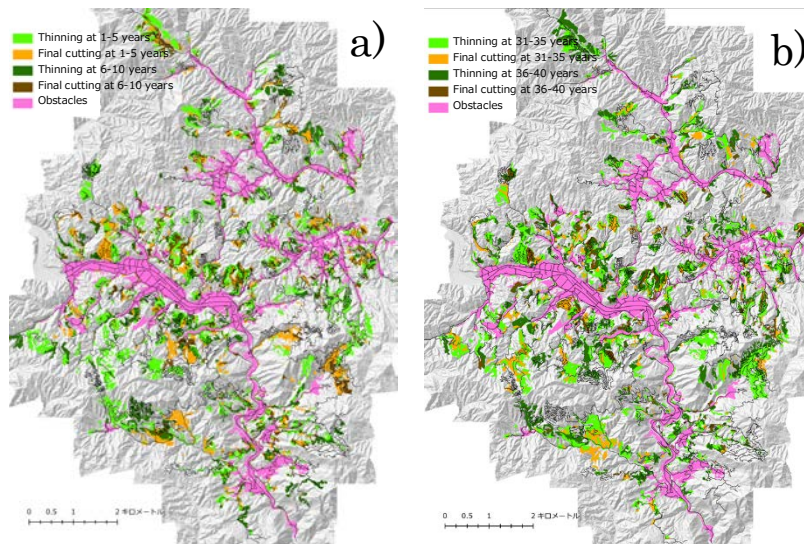

Figure 4. Examples of operation plan. a) 1-10 fiscal years, b) 31-40 fiscal years

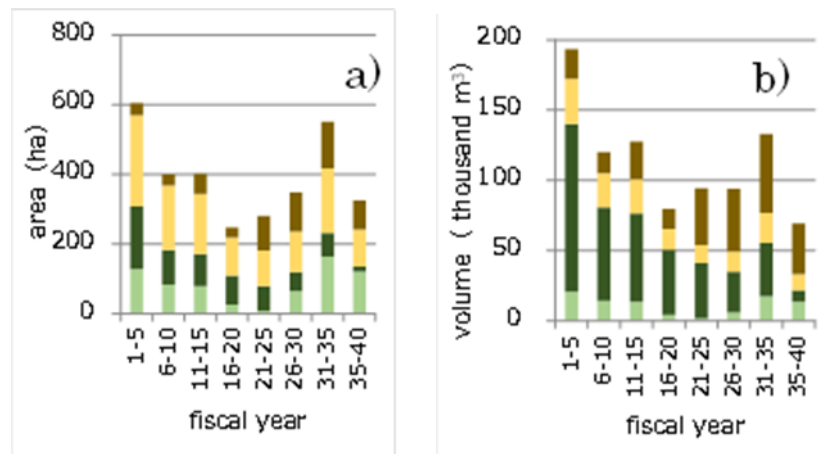

Figure 5. Planned operational area and volume. a) area, b) volume

As shown in Figure 5, operational area and volume is varying with each planning term. This is the large problem in actual operation because they have upper and lower limit in investable labors, machines, and trade contract with sawmills. Thus leveling of supply amount is important for stable supply and production organization. In addition, planning amount should be flexible with economic situation because wood demand varies in quite shorter period than tree growth period. Not only quantity planning but also quality information is important.

### 3.4 Transition of stand condition

Figure 6 shows examples of estimated transition of stand condition in harvestable stands in accordance with the plantation management plan as Table 3. While stand age distribution in presence is quite concentrated, this plan leads it to a bimodal distribution. Combined analysis of wood supply and transition of stand condition is useful for not only stable forestry economic management but also sustainable forest ecosystem management.

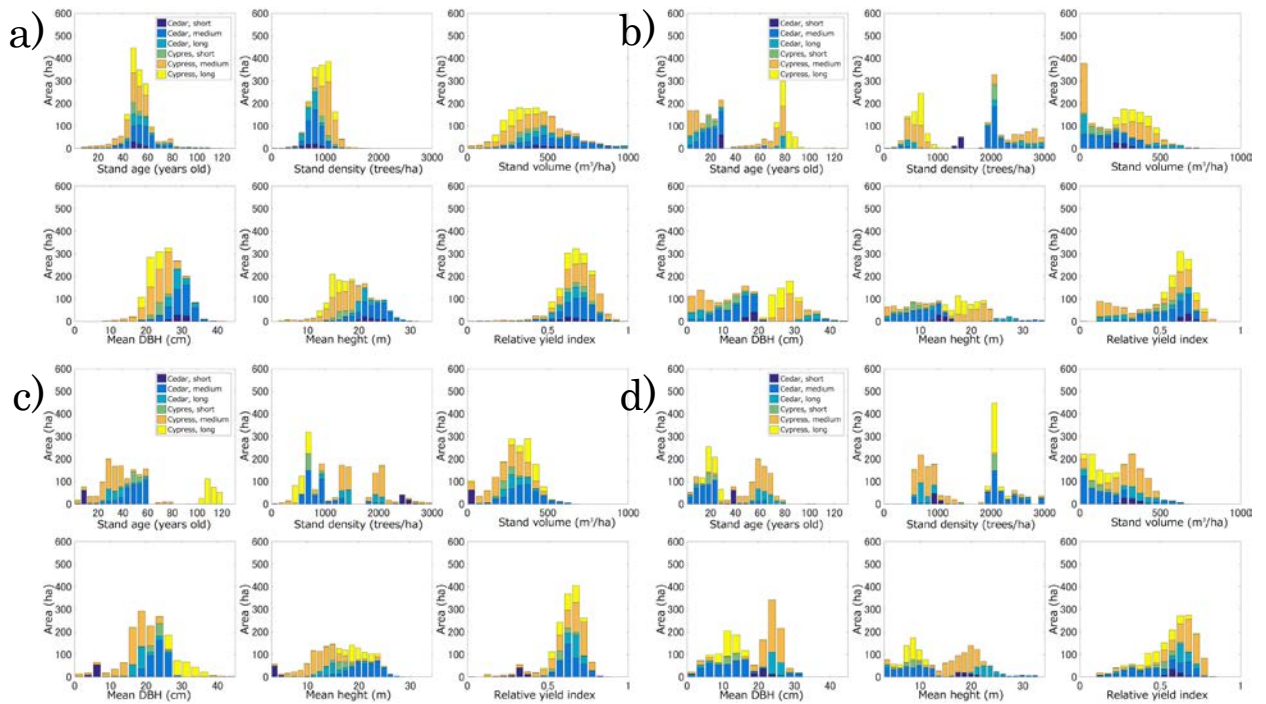

Figure 6. Examples of transition of stand condition. a) at present, b) 30 years later, c) 60 years later, d) 90 years later

## REFERENCES

- Hyypä, J., Hyypä, H., Yu, X., Kaartinen, H., Kukko, A., and Holopainen, M. (2008) “Forest Inventory Using Small-Footprint Airborne Lidar.” *Topographic Laser Ranging and Scanning: Principles and Processing*, 335-370, CRC Press.
- MacLean, D.A., Erdle, T.A., MacKinnon, W.E., Porter, K.B., Beaton, K.P., Cormier, G., Morehouse, S., and Budd, M. (2001) “The Spruce Budworm Decision Support System: forest protection planning to sustain long-term wood supply” *Can. J. For. Res.*, 31, 1742-1757.
- Shiraishi, N. (1986) “Study on the Growth Prediction of Even-Aged Stands.” *Bulletin of the Tokyo University Forests*, 75, 199-256. (in Japanese with English summary)

## P-11

### **Productivity of logging large-diameter and long logs for final cutting in a moderate mountain forest**

Masahiko Nakazawa <sup>1, \*</sup>, Chikashi Yoshida <sup>1</sup>, Tatsuya Sasaki <sup>1</sup>, Seishiro Taki <sup>1</sup>, Takumi Uemura <sup>1</sup>, Takayuki Ito <sup>1</sup>, Hirokazu Yamaguchi <sup>1</sup>, Masahiro Mozuna <sup>1</sup>, Kengo Usui <sup>1</sup>, Yuta Inomata <sup>1</sup>, Hidenori Suzuki <sup>1</sup>, Satoshi Yamaguchi <sup>1</sup>, Hiroko Muneoka <sup>1</sup>, Yoshiaki Tanaka <sup>1</sup>, Masaki Jinkawa <sup>1</sup>, Kotaro Zushi <sup>2</sup> and Hideharu Aiura <sup>2</sup>

<sup>1</sup> Forestry and Forest Products Research Institute, 1 Matsunosato, Tsukuba 305-8687, Japan.

<sup>2</sup> Toyama Prefectural Agricultural, Forestry & Fisheries Research Center, Forestry Research Institute, 3 Yoshimine, Tateyama 930-1362, Japan.

\*Corresponding author: Tel: + 81-29-829-8284 E-mail: [naka1978@ffpri.affrc.go.jp](mailto:naka1978@ffpri.affrc.go.jp)

**Abstract:** Today, a large part of artificial forests in Japan have reached maturity. These trees are becoming larger, and it is more difficult to log them using current techniques. This study aimed to develop a logging system for larger diameter and longer logs than usual in Japan. We examined the productivity of final cutting in a moderate mountain forest in Toyama Prefecture and compared the productivities of each log length class (4, 6, 8 m) using both current and bigger machine harvesting systems. Moreover, felling techniques for large-diameter trees were considered using a mechanical wedge popular in central Europe. Consequently, the safety of felling using the mechanical wedge and the productivity using the bigger machine system were higher than those by the current techniques and systems; on the other hand, the productivities of each log length class differed slightly.

**Keywords:** productivity, logging, large-diameter and long logs, final cutting, moderate mountain forest

#### **1. INTRODUCTION**

Recently, a large part of artificial forests in Japan have reached maturity and are more than the standard rotation age in Japan (40 years in general). These trees are becoming larger, and logging those using current techniques is becoming more difficult. This study aimed to develop a logging system for larger diameter and longer logs than usual in Japan. To this end, we examined the productivity of final cutting in a moderate

mountain forest in Toyama Prefecture. Moreover, felling techniques for large-diameter trees were considered using a mechanical wedge popular in central Europe.

## 2. METHODS

The operation system included felling with a chainsaw, processing with a processor, and forwarding with a forwarder. Felling operation was carried out using a chainsaw with a normal wedge hit by a hand ax and mechanical wedge driven by ratchet (Figure 1). Processing operation using a processor mounted excavator of current size (0.5 m<sup>3</sup> of bucket capacity) and a larger one (0.65 m<sup>3</sup> of bucket capacity) (Figure 2) in some cases included prehauling operation with a grapple loader. Forwarding operation using a forwarder of current size (4.8 ton of load capacity) and a larger one (6 ton of load capacity) (Figure 3) included loading and unloading with a grapple loader. We examined the productivity of final cutting in a moderate mountain forest in Toyama Prefecture and compared the productivities of each log length class (4, 6, 8 m) using both current and bigger machine harvesting systems. Each operation was observed by video cameras. We then performed time analysis for each operation and calculated their productivities. A summary of the study sites for the current and bigger machine harvesting systems is shown in Table 1. The tree species in the sites was sugi (*Cryptomeria japonica*).



Figure 1. Normal wedge and mechanical wedge



Figure 2. Processors



Figure 3. Forwarders

Table 1. Summary of the study sites

	Current machine site	Bigger machine site
Tree density (trees/ha)	832.3	587.1
Mean breast height diameter (cm)	39.7	49.4
Mean tree height (m)	29.6	33.4
Mean stem volume (m <sup>3</sup> /tree)	1.7	2.7
Stem volume (m <sup>3</sup> /ha)	1394.2	1567.1
Yield index	1.04	1.00
Site index	26.2	29.5

### 3. RESULTS AND DISCUSSION

#### 3.1 Felling operation

Results of the felling operation using normal and mechanical wedges are shown in Table 2, and the relationship between felling productivity and breast height for each wedge is shown in Figure 4. All trees were felled upside toward strip roads. Although the mean stem volume for the normal wedge was smaller than that for the mechanical wedge, the productivity of the normal wedge was slightly higher than that of the mechanical wedge. The cycle times of each element work of felling for the normal and mechanical wedges are shown in Figure 5. The cycle time of felling operation of the normal wedge was less than that of the mechanical wedge due to the time of wedging work. On the other hand, the cycle times of the other element work were almost the same. Moreover, the safety of the mechanical wedge felling was confirmed, because the worker was able to drive the ratchet on the upper or lateral side of the felling trees, where the felling trees should not slip down.

Table 2. Results of felling

	Normal wedge	Mechanical wedge
Number of trees	28	28
Mean stem volume (m <sup>3</sup> /tree)	1.39	1.60
Productivity (m <sup>3</sup> /h)	19.5	19.0

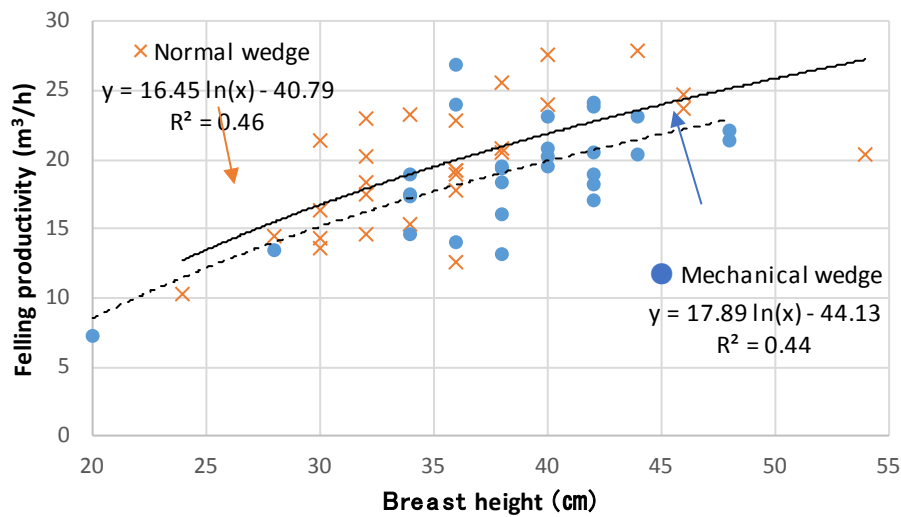

Figure 4. Relationship between felling productivity and breast height

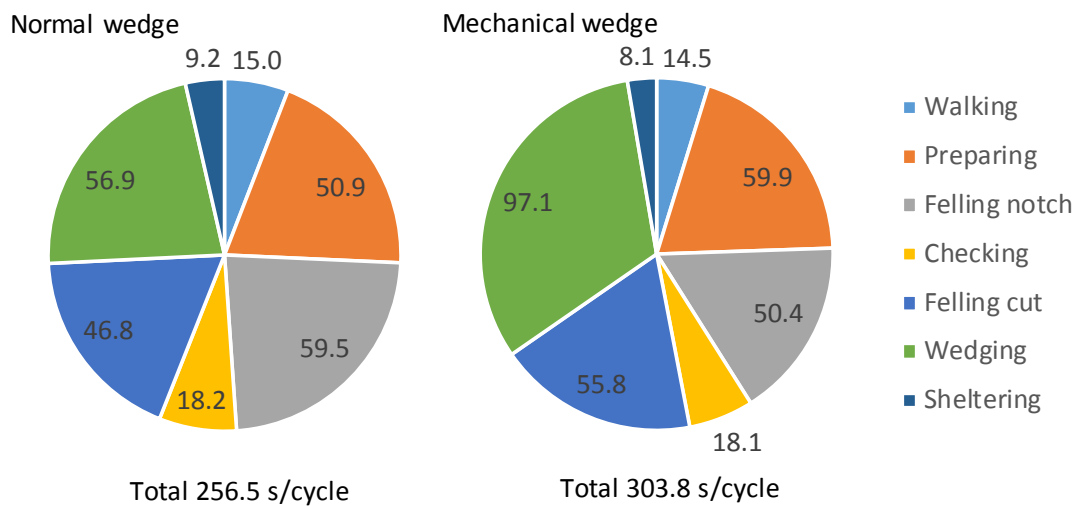

Figure 5. Cycle time of each element work of felling operation

### 3.2 Processing operation

Results of the processing operation using the current and bigger machines are shown in Table 3, and the relationship between processing productivity and breast height for each log length class is shown in Figure 5. The productivity of the bigger machine was higher than that of the current one, and the differences in productivity among log length classes



were not so large, although the mean number of cutting was increasing with shortening log length.

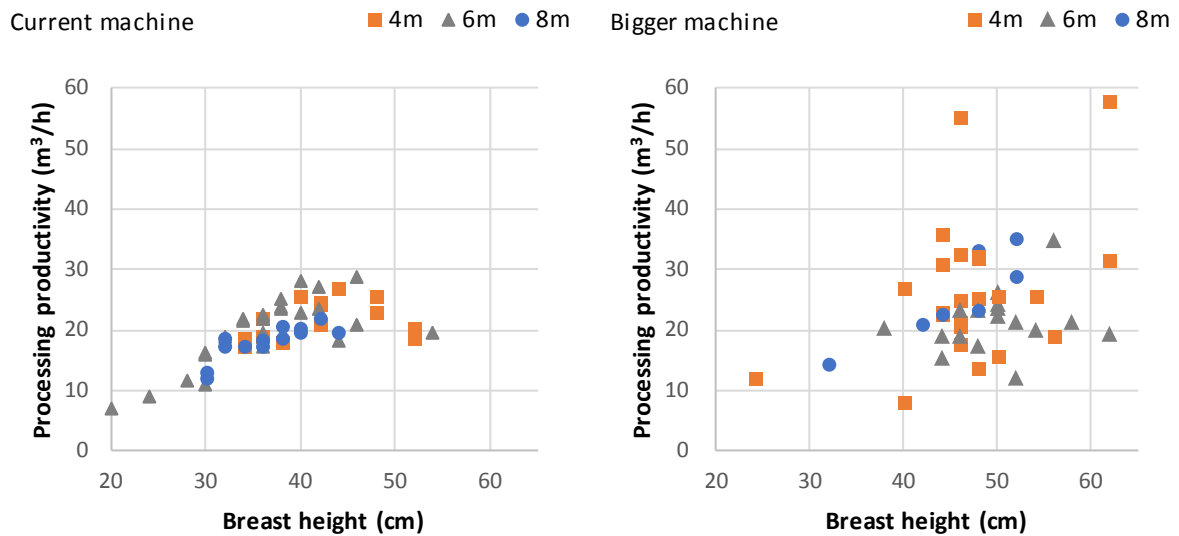

Figure 6. Relationship between processing productivity and breast height

Table 3. Results of processing operation

	Log length (m)	Number of tree	Mean stem volume (m <sup>3</sup> /tree)	Mean number of cutting	Productivity (m <sup>3</sup> /h)
Current machine	4	15	1.83	7.5	16.8
	6	25	1.44	5.4	16.9
	8	13	1.42	4.9	16.0
Bigger machine	4	23	2.52	7.3	23.3
	6	17	2.60	5.6	20.4
	8	7	2.37	4.6	25.3

### 3.3 Forwarding operation

Results of the forwarding operation using the current and bigger machines are shown in Table 4, and the forwarding productivity for each log length class is shown in Figure 7. The forwarding distances were around 150 m. The productivities of the bigger machine were higher than those of the current one and were decreasing with increasing log length, especially for the current machine.

### 3.4 Whole harvesting system

Calculation of the total productivity using current and bigger machine harvesting

systems for each log length class is shown in Table 5. The productivity of felling operation was used for the mechanical wedge. The productivities of the bigger machine system were higher than those of the current one. The productivities using the current machine system were low in the longer log class; on the other hand, those using the bigger system were high in either log length class.

#### 4. CONCLUSIONS

This study aimed to develop a logging system for larger diameter and longer logs than usual in Japan. We examined the productivity of final cutting in a moderate mountain forest in Toyama Prefecture and compared the productivities of each log length class (4, 6, 8 m) using both current and bigger machine harvesting systems. Results showed that the safety of felling using the mechanical wedge and the productivity using the bigger machine system were higher than those by the current techniques and system; on the other hand, the productivities of each log length class differed slightly.

Table 4. Results of forwarding.

	Log length (m)	Number of cycles	Mean loading volume (m <sup>3</sup> /cycle)	Productivity (m <sup>3</sup> /h)
Current machine	4	9	5.05	18.7
	6	5	4.89	11.5
	8	8	2.37	11.7
Bigger machine	4	7	5.88	27.1
	6	4	7.49	25.0
	8	4	6.01	22.0

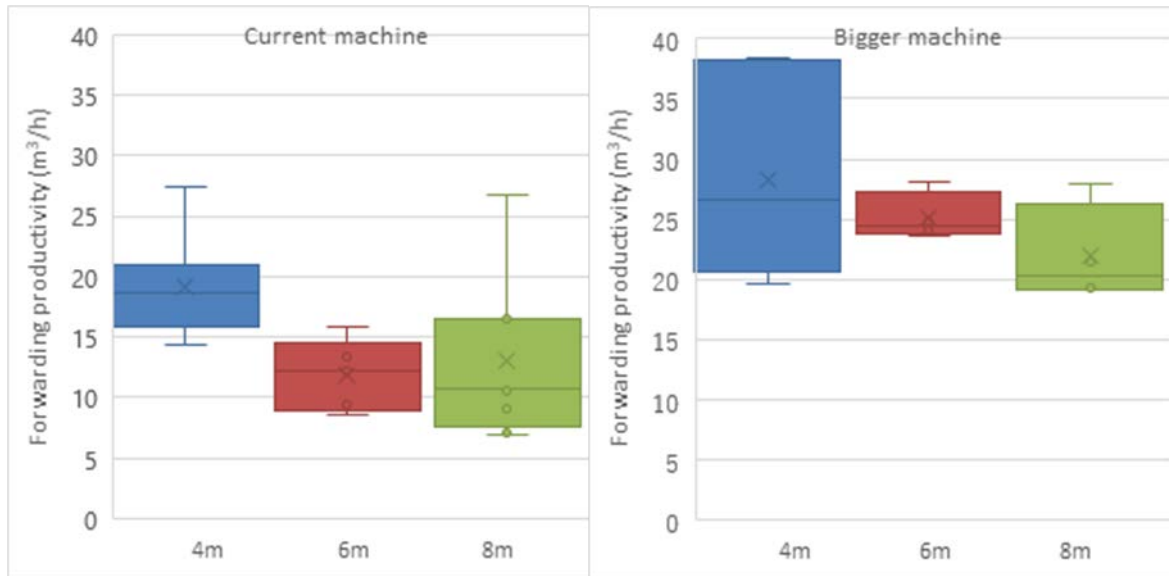

Figure 7. Forwarding productivity for each log length class

Table 5. Calculation of productivity for each harvesting system

	Log length (m)	Productivity (m <sup>3</sup> /man-hour)			Total
		Felling	Processing	Forwarding	
Current machine system	4	19.0	16.8	18.7	6.0
	6		16.9	11.5	5.0
	8		16.0	11.7	5.0
Bigger machine system	4	23.3	27.1	7.5	
	6	20.4	25.0	7.1	
	8	25.3	22.0	7.3	

## P-12

### **Improving Forestry Strip Roads and Assessing the Possible Introduction of Logging Operation Systems**

Shin Yamasaki<sup>\*,1</sup>, Toshihiko Yamasaki<sup>1</sup>, Yasushi Suzuki<sup>2</sup>, Yukihiro Mitani<sup>3</sup>,  
Masanobu Morimoto<sup>3</sup> and Yoshiaki Nagasawa<sup>4</sup>

<sup>1</sup> Kochi Prefectural Forestry Research Center, Kami 782-0078

<sup>2</sup> Faculty of Agriculture and Marine Science, Kochi Univ., Nankoku 783-8502

<sup>3</sup> Kami Forestry Association, Kami 781-4212

<sup>4</sup> Kochi Prefecture Forestry Association, Kochi 780-0046

\* Corresponding author: Tel: +81-887-52-5215

E-mail: [shin\\_yamasaki@ken3.pref.kochi.lg.jp](mailto:shin_yamasaki@ken3.pref.kochi.lg.jp)

**Abstract:** The Kurotaki area of Nankoku city, Kochi Prefecture, Japan, has long been well known for forestry activities by local residents. One such activity is making a narrow forestry strip road network in steep terrain and extracting logs using small winches. However, in recent years, problems have occurred, namely, a decrease in the number of forestry workers because of a lack of successors willing to engage in forestry work and efficient work is becoming difficult using conventional methods because of the large size of the trees planted during the 1950s to 1970s. Therefore, the forest owners' cooperative of the area, instead of the local forest workers, has started to perform logging operations using newly introduced forestry machines. In this presentation, we will report on the results of a survey of the operational efficiency of both the conventional logging method and the newly introduced European tower yarder.

**Keywords:** Steep slope, Strip road, Logging operation system, Tower yarder

#### **1. INTRODUCTION**

Kochi Prefecture has the highest forest ratio in Japan at 84%, and many of the forests are established in areas where the slope gradient is steep. Therefore, because work cannot be directly carried out with forestry machines such as harvesters and processors in the forest, the logging work is done manually, mainly with chainsaws, and collecting work is mainly done using wire cables. In addition, Kochi Prefecture has a number of small forestry holding areas per forest. In Kochi Prefecture, Forest householders who hold forests less than 3 ha account for 46% of the total, and who hold forests less than 10 ha account for 81% of the total (MAFF 2017). For this reason, if an owner manages their forest land on their own, work efficiency is poor, so a method of consolidating the

forest land of multiple forest owners should be applied.

When thinning is conducted in such an intensive management site, the operation is often carried out using a large-scale logging cable system such as the H-type system in the Shikoku Area (Handa 2005). However, in many other cases over many years, a road network of small strip roads less than 3 m wide is set up on a steep slope, and operations are conducted using compact forestry machines such as small winches for collecting materials and small forwarders and trucks for carrying logs. In the present situation, the advantage of consolidating the forest land is not still be utilized. For efficient thinning operations in consolidation areas, using a medium-range tower yarder (a heavy forestry machine) should be considered (Nakazawa et al. 2012, 2015). Introducing such large-scale forestry machines requires wide strip roads with a minimum width of 3.5 m. However constructing such wide roads over already established small-scale strip roads is difficult. In this study, a trial method of improving the existing strip road network was investigated. Using this method made it possible to introduce heavy forestry machinery. We also examined the improvement in raw wood productivity.

## **2. SUMMARY OF THE FIELD WORK**

A field survey was conducted in the Kurotaki area, Nankoku City, Kochi Prefecture. In this area, the forest owners have long been engaged in forestry work. As a result, numerous strip roads have been constructed in the forest areas, but many are narrow with tight curves, making it difficult for forest workers to operate heavy machines. Therefore, by widening the strip roads and creating wider curves, we investigated whether productivity can be improved by using a European medium-range tower yarder for logging and heavy logging trucks for transportation. This study was conducted at the Kami Forestry Association's consolidated work area (Figure 1). According to the public forest register, this work area is 311.6 ha, 82% of which is Japanese cedar and Japanese cypress, with the remaining 18% mainly Japanese red pine, fir, and broadleaved trees. All the Japanese cedar is 35<sup>th</sup> grade (35 years old) and the Japanese cypress is a minimum of 40<sup>th</sup> grade. And these forests are aging.

The number of stands where thinning is delayed is increasing. The extension of the strip roads in the operation area was about 20.5 km and the density of the strip roads was 61 m/ha. However, many of the strip roads are narrow with tight curves, making it difficult for heavy trucks to traverse. Therefore, it may be difficult to introduce heavy high-performance forestry machinery with high work efficiency and direct delivery of logs to log markets by heavy trucks. In the operation area, the age of the forest has increased and the tree diameters are becoming larger. Therefore, when the main harvesting period arrives, it was assumed the logging and unloading work of certain

materials would not proceed because of the scale of the large trees.

### **3. IMPROVING THE STRIP ROADS AND WORK SYSTEM**

The strip roads were improved along two routes in the work area. The first line was a 4,850 m long working road from the entrance of the work area to the center. It was assumed that the thinning operation would be performed using a medium- to long-distance type tower yarder and the logs would be transported by a 10-ton truck. The roads (including the shoulder) were improved as a trunk line strip road with a total width of 3.5 m or more and a minimum curve radius of 8.0 m (Figure 2).

The second line was a 3,500 m strip road from the central part of the operation area to the north part of the area. The curve radius narrowed and it was difficult to change the gradient of the roads, depending on the terrain conditions. That is, it was difficult for an 8-ton truck to traverse. By using a 0.45 m<sup>3</sup> class bucket shovel machine, we improved the road as a branch strip road with a minimum width of 3 m and a minimum curve radius of 7 m. Furthermore, by establishing an on-site earth dump at the intersection of the main strip road and the branch strip road, we accumulated the materials removed from the low standard strip road and transferred them to the other sites using heavy trucks (Figure 3).

### **4. STUDY OF THE LOGGING OPERATION SYSTEM**

To verify the effectiveness of the operation system introduced after improving the strip roads, we conducted a feasibility study on the operation system before and after improving the strip roads and compared the labor productivity. The study was carried out in area A (Figure 4) where the Kami Forestry Association was able to introduce a medium-distance tower yarder after the strip roads were improved. In area B (Figure 5), the operation method used a swing yarder for winching. In area C (Figure 6), the operation method used a small winch attached to a small excavator. In addition, as a result of improving the roads in area A, it was possible to transport the extracted logs directly by 10-ton truck, so additional transportation using small trucks was no longer necessary. Table 1 shows the operating entities of the study areas, the forestry machinery used, the outline of the study area, and the survey results are shown in Table 2.

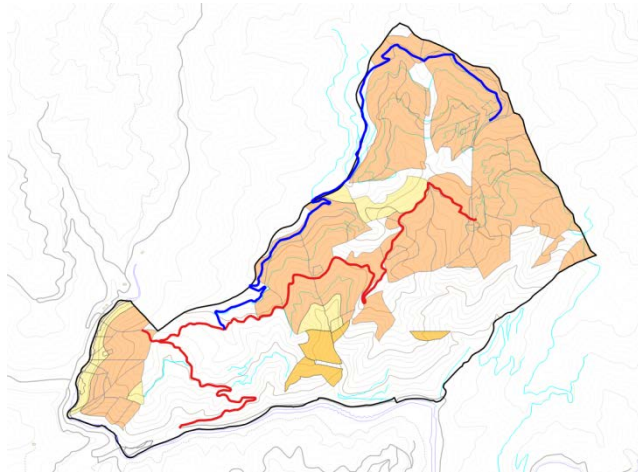

Figure 1. Operation area

Red: Main road; Blue: Branch road

Before



After



Figure 2. Improving the strip roads

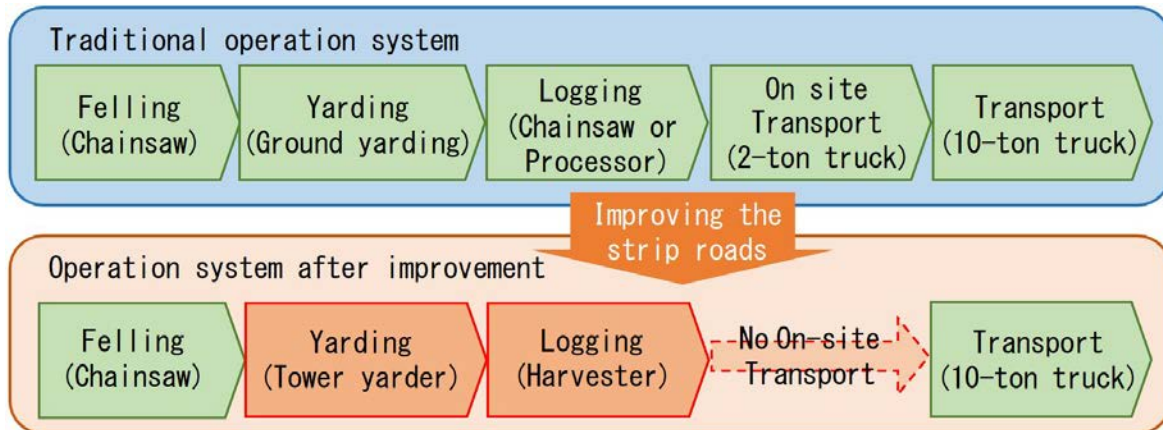

Figure 3. Operation system before and after improving the strip roads



Figure 4. Area A: Tower yarder

Figure 5. Area B: Swing yarder

Figure 6. Area C: Small winch

Table 1. Organization and operation system

Area	Organization	Felling	Collecting	Logging	Small transportation
A	Forestry association	Chainsaw	Tower yarder (MM WaderFalke)	Harvester (0.45 m <sup>3</sup> )	Unnecessary
B	Forestry association	Chainsaw	Swing yarder (0.25 m <sup>3</sup> ) Ground yarding	Processor (0.45 m <sup>3</sup> )	2-ton truck
C	Forester	Chainsaw	Small winch (0.25 m <sup>3</sup> ) Ground yarding	Chainsaw	2-ton truck

Table 2. Results of the survey

Area	Species	number/ha	m <sup>3</sup> /ha	Thinning tree volume (m <sup>3</sup> )	Labor productivity per hour		
					Felling Collecting Logging	Transporting	All Work
A	Japanese Cedar	428	697	0.60	1.12	None	1.12
B	Japanese Cypress	1,383	351	0.22	1.01	1.96	0.67
C	Japanese Cypress	1,979	401	0.16	0.30	2.65	0.27

## 5. RESULTS AND CONSIDERATION

Labor productivity of the logging work after the strip roads were improved was highest in area A at 1.12 m<sup>3</sup>/person hour, followed by areas B and C at 1.01 and 0.30 m<sup>3</sup>/person hour, respectively. Because large trucks cannot enter areas B and C, short transportation to the landing was required for these two areas. As a result of including the productivity of short transportation, labor productivity fell to 0.67 m<sup>3</sup>/person hour in area B and 0.27 m<sup>3</sup>/person hour in area C. In this study, labor productivity using the tower yarder in area A was the highest. Although there may be differences depending on individual operational conditions, improving productivity by improving strip roads and introducing



heavy forestry machinery is possible. In addition, area A could be considered to have factors favoring high productivity, such as the size of single trees is larger compared with the other two areas. However, in using a middle- to long-distance tower yarder, it is possible to perform efficient work even if the tree size is large.

These results show that working efficiently in a centralized operation area requires establishing strip roads that can accommodate heavy forestry machinery and introducing a medium-range compatible operation system such as a tower yarder. In the future, establishing a method of opening large-scale strip roads on steep slopes and establishing a safer and more efficient route selection method are issues that need to be solved.

## REFERENCES

- Handa K, (1995) “H type overhead wire collection material effective for thinning operation” *Journal of the Forestry Mechanization Society* 497: 25–31. (in Japanese)
- Ministry of Agriculture, Forestry and Fisheries (2017) “The records of the census of agriculture and forestry 2015”
- Nakazawa M, Yoshida C, Sasaki T, Jinkawa M, Tanaka Y, Suzuki H, Uemura T, Ito T, and Yamasaki T, (2015) “Development of a thinning system with a medium-range tower yarder introduced from Europe – Productivity of uphill-lateral yarding –” *J. Jpn. For. Eng. Soc.* 30(1): 29–30. (in Japanese)
- Nakazawa M, Yoshida C, Sasaki T, Jinkawa M, Tanaka Y, Suzuki H, Uemura T, Ito T, Yamasaki T, Oya S, Furukawa K, and Imatomi Y, (2012) “Development of thinning system with a tower yarder newly introduced from Europe – Productivity of uphill yarding under the cable –” *J. Jpn. For. Eng. Soc.* 27(3): 175–178 (in Japanese with English Summary)

## P-13

### The Effects of Compaction on Operation road at the Constructing

Hiroki Matsunaga<sup>1</sup>, Masashi Saito<sup>2,\*</sup>, Shota Sugimori<sup>2</sup>, Dai Otsuka<sup>1</sup>, Tatsuhito Ueki<sup>2</sup>, Hidenori Suzuki<sup>3</sup>, Satoshi Yamaguchi<sup>3</sup>, Hiroko Muneoka<sup>3</sup>, Yoshiaki Tanaka<sup>3</sup>, Takayuki Ito<sup>3</sup> and Yuta Inomata<sup>3</sup>

<sup>1</sup> Graduate school of Science and Technology, Shinshu University, 8304 Minamiminowa, Nagano 399-4598, Japan.

<sup>2</sup> Faculty of Agriculture, Shinshu University, 8304 Minamiminowa, Nagano 399-4598, Japan.

<sup>3</sup> Forestry and Forest Products Research Institute, Tsukuba, Ibaraki, 305-8687, Japan.

\*Corresponding author: Tel: + 81-265-77-1652 E-mail: [m\\_saito@shinshu-u.ac.jp](mailto:m_saito@shinshu-u.ac.jp)

**Abstract:** It is required to perform sufficient compaction at the construct Operation road, because it is based on the soil structure. However, there are cases that compaction is not sufficiently at the constructing based on the idea that can be compacted the vehicle running. Operation road must be not only save the cost, but also having durability and safety. In this study, we carried out the effects of compaction on strength and road surface condition of Operation road. As a result, the CBR value representing the strength of the surface layer was not greatly different whether or not compaction was performed, but the Nd value indicating the inside bearing capacity was confirmed that there was a tendency lower than 5 which is the weak layer. Without compaction, the amount of subsidence surface layer of the road increased after running the vehicle.

**Keywords:** Operation road, compaction, bearing capacity, CBR value, Nd value

## 1. INTRODUCTION

In order to establish a low cost and durable road network, sufficient compaction is required at the time of construct the Operation road, because it is based on the soil structure. However, in the actual site, it is judged that compaction will be done to some extent at the time of construction and vehicle running after construction, sufficient work may not be done at the time. Even in the realization of sustainable forest management, it is also necessary to establish an effective Operation road for subsequent work and management. On the other hand, the Operation road is constructed according to the conditions of the site, research on the technology is shallow. Based on the existing

research results, compaction at the time of construction was found to be less effective after the surface layer of about 30 cm (Usuda et al., 2016), and the surface layer was compacted by secular change, but the bearing capacity internal the roadway did not improve (Sawaguchi et al., 2011). Establishing low cost and highly durable construction technology about Operation road, we have to compare and verify not only strength before and after running of the vehicle on sufficiently compaction the road body at the time of constructing, but also without compacting that. In this research, we pointing out the importance of compaction and clarify the influence of compaction at the time of construction.

## 2. STUDY SITE AND RESEARCH METHOD

The study site is compartment 3 of Shinshu University Forest. From October to November 2016, a new Operation road was constructed to thinning operation. The geology of the site is mainly consists of Granite. We set up the test section on this Operation road. The setting is the compaction zone (hereafter zone A) and the not compact zone (hereafter zone B). In zone A, excavated natural ground, then filled with about 50 cm each further, rolling down with backhoe bucket, and compacted the road body. While in zone B, excavated soil was not rolled into a layer, it was backfilled as road body, and the road surface was flattened only with the bucket of the backhoe. The construction was carried out with the backhoe, there was a rolling pressure by the backhoe traveling through the rut portion which the crawler passes also in zone B. In order to make the number of vehicle travels and the environmental conditions uniform, the test area was set at intervals of about 8 m in sections where no bending or gradient change was observed and set at 10 m each. The road width was 3.5 m and the longitudinal gradient was 2.5% (Figure 1).

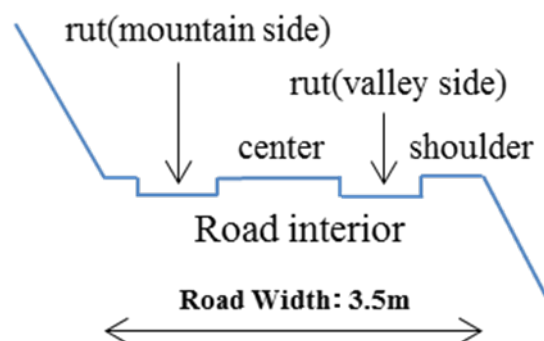

Figure 1 Cross sectional view of road

After construction, the running of the processor and the transportation of the harvested woods by the forwarder were performed a plurality of times. As breakdowns, backhoe (ZAXIS 135US) which accompanied by construct the Operation road running 6times, backhoe (CAT 312B) 12times, processor (HITACHI EX 130 K) twice, forwarder (IWAJUJI U-5C) 14 times. Seven were empty and seven were loaded with timber. Also, light truck runs two times. In addition, because there was a possibility that the number of times the vehicle traveled was not sufficient, a running test (42 times) by backhoe (KOMATSU PC 30MR) was additionally performed.

In the test site, we conducted several experiments to compare the compaction of the road, before and after the vehicle running and running test by the backhoe. Experimental contents are survey of supporting force internal the road by Simple dynamic cone penetration test, measure the road surface condition by Simple bearing capacity measuring device (CASPOL), and measure the traverse shape of road surface by Total station (TS). In addition, in order to grasp the difference in specific gravity and moisture content due to differences in the method of construction, Effective volumetric capacity test was conducted using a sampled cylinder. Measurement the supporting force of internal road body was carried out at each 12 points in 3 m, 5 m, 7 m lines of test zone, mountain side rut, center, valley side rut and road shoulder were set as one set. The penetration depth was assumed to reach the ground, and if the Nd value exceeded 20, the test was done. It is clear that the embankment collapse tends to occur when the Nd value is less than 5 (Goto et al., 2014). About surface layer, measure on the mountain side rut of the same line, the center, and the valley side rut of the same line, and each measurement was carried out five times. In each case, the measurement position was slightly shifted, and the result was carefully checked so as not to be affected by the penetration test hole or the shock of the CASPOL's rammer-drop. Transverse shape of the road surface was carried out at intervals of 5 cm for each four lines of 2 m, 4 m, 6 m and 8 m in each section. The Effective volumetric capacity test was sampled at each of the valley side rut and the center of zone.

### **3. RESULTS AND DISCUSSION**

#### **3.1. Compaction at the time of construction and internal road bearing capacity**

The Nd value after the construction was high in zone A on the center and road shoulder (Figure 2). The Nd value exceeds 5 in zone A in the center and road shoulder, while in zone B it was significantly lower than 5 until reached the ground. There were several dangers of embankment collapse at the time of construction.

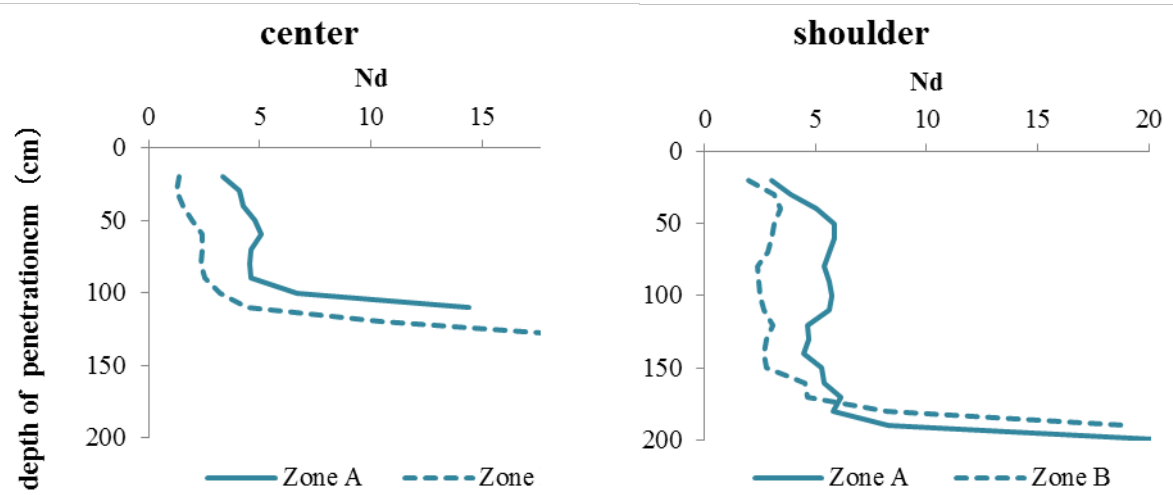

Figure 2 Nd- value (after constructing)

**3.2. Relationship between running the vehicle and bearing capacity of road surface**  
 CBR value tending to high in both ruts in zone A and B (Figure 3). It expressing that the bearing capacity was increase on the rut than center, due to the running of the vehicle. Regarding the surface layer of rut, the same supporting force can be obtained by running the vehicle after construction regardless of compaction at the time of construction. There was no big difference in CBR value between each zone.

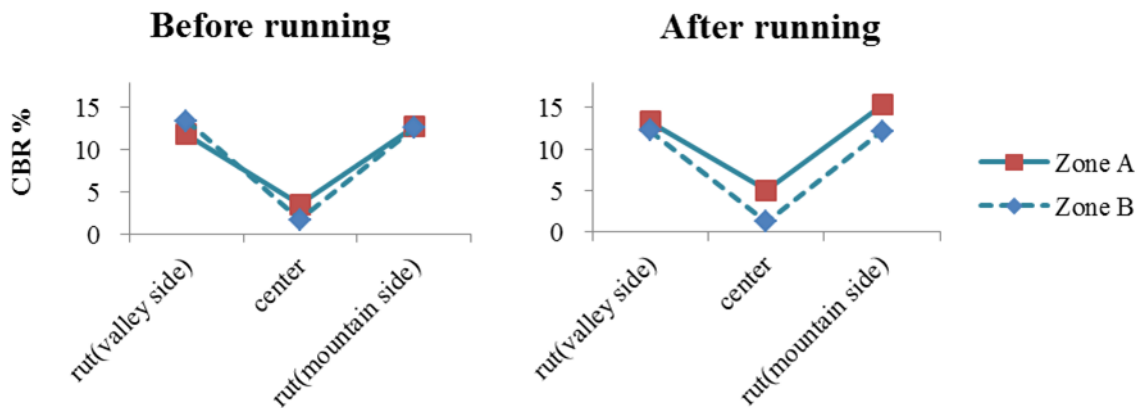

Figure 3 CBR-value

**3.3. Relationship between running the vehicle and internal road bearing capacity**  
 According to figure 4, bearing capacity after running test zone B tended to be lower than that of zone A (Figure 4). Also, in zone B, there are the points which the Nd values

were less than 5 as in the case just after the construction, even if on the rut where the crawler passes. When compaction was not done at the time of construction, it became clear that sufficient road support power could not be obtained even if there is a vehicle running after construction. Considering the running of the vehicle such as logging and transporting, the result indicating that whether or not tightening determines the danger of collapse of the internal Operation road.

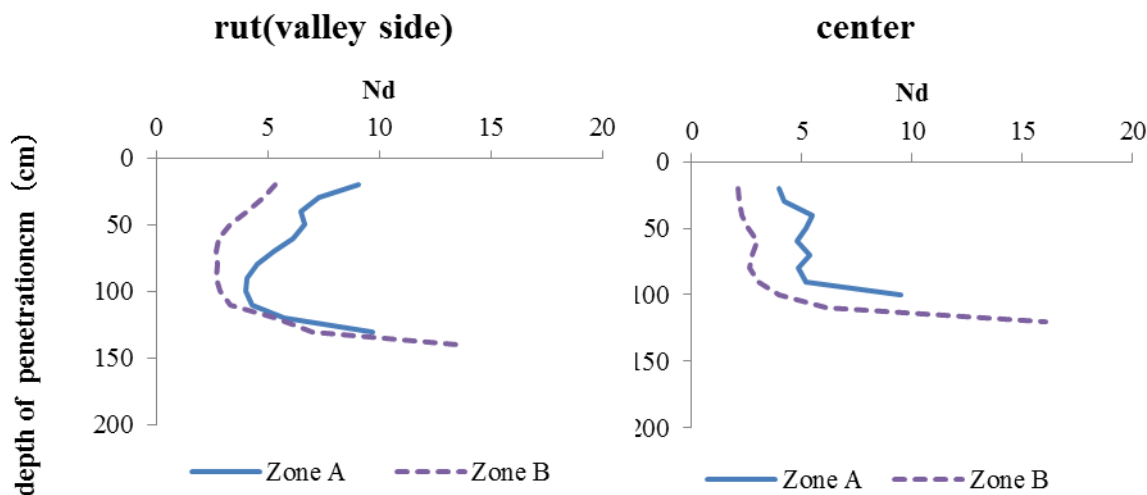

Figure 4 Nd-value (after running)

The results of the Effective volumetric capacity test are shown in Table 1. In zone A, the solid phase both occupied half on the valley side rut and center. While zone B, the solid phase was about half with the valley side rut, however the center was 37%. Where not only the ratio of the solid phase was low but also the bulk density variation was observed. The moisture ratio zone B was both lower than zone A.

Table 1 Moisture ratio

zone	moisture ratio	solid phase(%)	liquid phase(%)	air phase(%)	
A	rut	0.13	50.52	18.67	30.82
	center	0.13	49.50	17.53	32.97
B	rut	0.28	47.79	36.40	15.81
	center	0.25	37.24	27.18	35.58

### 3.4. Comparison of road crossing shapes

Cross-sectional shape of the road surface was comparatively smooth even after running test in zone A, however in zone B, there was a difference in elevation between two ruts, the center, and the shoulder. Especially after running test, the subduction in the rut was

increased. In zone A, as a result of compaction done at the time of construction, sinking due to the compacting of the soil on the road surface in the test section became small even the vehicle running afterwards. Compared with zone B as a result, compaction was not done at the time of construction, it is considered that the subsidence became large and the height difference of the road surface became large.

#### **4. CONCLUSIONS**

In this study, we point out that if the compaction was not done at the time of construction of the Operation road, the rolling pressure due to running of the vehicle, it was not possible to secure enough supporting force of the road.

In addition, we clarify that unless compaction was done, the rut greatly subsided due to running of the vehicle after construction, and the undulation of the road surface became large. The unevenness of the road surface is severe, waste water will not be properly taken and there is a possibility that road surface erosion such as rainfall become severe. In conclusion, it is important to compare the strength of the road body, considering whether or not compaction has been carried out and the vehicle running along with felling. We point out based on this survey that compaction at the time of construction is important for the durable Operation road.

#### **ACKNOWLEDGEMENT**

This work was supported by JSPS KAKENHI Grant Number JP15K18709.

#### **REFERENCES**

- Goto J., Yoshihara O., Mori D. and Suzuki Y. (2014) "Considerations in the structure and the construction of spur roads for heavily loaded vehicles such as tower yarders." *J. Jpn. For. Eng. Soc.*, 29 (1) : 5~12, 2014.
- Sawaguchi I., Takahashi Y., Tatsukawa S. and Takahashi T. (2011) "Aged change of bearing capacity of new construction skidding road." *J.Jpn. For. Eng. Soc.*, 26 (2) : 97~104, 2011.
- Usuda H. Watada T. and Sugimoto K. (2016) "Relationship between the method of roadbed construction and bearing capacity." *Abstract of Annual Meeting, J.Jpn. For. Soc.2016.*

## P-14

### Moso Bamboo Strip Bundles for Surface Drainage of Slippery Roads

Satoshi YAMAGUCHI\*, Hidenori SUZUKI, Hiroko MUNEOKA, Yoshiaki TANAKA  
and Masaki JINKAWA

Forestry and Forest Products Research Institute (FFPRI), Japan

\*Corresponding Author, E-mail: [syamaguc@ffpri.affrc.go.jp](mailto:syamaguc@ffpri.affrc.go.jp)

**Abstract:** Ditches are necessary on wet, slippery roads to drain surface water, but they can inconvenience automobile traffic due to bump impact. Water leakage from the ditches occurs when they are impacted by wheel load. To address these issues, bundles of stripped bamboo and a thick node-free bamboo culm with drilled holes were used as ditch fillers. Because of the preponderance of Moso bamboo forests in Japan, this type of bamboo is easily available and extensively used owing to its low weight and high strength. We found that while the bamboo culm broke after 6 months of usage, the stripped bamboo bundle did not. The latter type of bamboo was studied further to determine the cause of its superior performance.

**Keywords:** Bamboo, Slippery road, Ditch, Wheel load, Bundling

#### 1. INTRODUCTION

In forest management, efficient surface drainage must be provided during the construction of forest and spur roads to prevent the erosion of road surface by rainwater and spring water. One effective type of surface drainage approach involves digging a cross ditch on the forest and spur roads. However, this inconveniences automobile traffic because of the resultant bump impacts. To address this issue and simultaneously ensure surface drainage, bundles of Moso bamboo (*Phyllostachys heterocycla* f. *pubescens*) made of Moso bamboo strips were fitted into ditches (Yamaguchi et al., 2010) (Photo 1). Another strategy is to use a Moso bamboo culm. Since the culm is too thick and hard to be cut into strips, the nodes were removed and holes were drilled into it to allow water passage for surface drainage (Photo 2). Within 6 months, however, the upper side of the cross drain fractured along the fiber direction (Photo 3).





Photo 1: Cross ditch made with stripped Moso bamboo



Photo 2: Cross ditch made with a node-free Moso bamboo culm, with drilled holes for water passage



Photo 3: Cross ditch shown in Photo 2 after 6 months

## 2. MATERIALS AND METHODS

The strengths of the Moso bamboo sticks and bundles were examined via bending and compression tests, respectively. Moreover, the necessary precautions required to use split bamboo as a civil engineering material were also considered.

Initially, a section of bamboo stick was shaped into an arch. When a load is applied from the outside of the arch with both ends moving, it is presumed that tension is applied to the inside of the arch, causing it to break easily. Although an average section of a bamboo stick is arch-shaped, we assumed a flat-shaped section was assumed in this study for ease of calculation of the bending strength. Specifically, we assessed the strength of bamboo sticks against wheel load. Bamboo breaks along the fiber direction, and it forms arch-shaped sections when split. Arched sections have a lower bending strength when they are free from nodes at both ends. For ease of calculation, the bending strength was examined with the assumption that the bamboo stick sections are trapezoids (Figure 1). The Moso bamboo test specimens were prepared in accordance with the average dimensions of a test specimen used for the bending test (Yamaguchi et al., 2017).

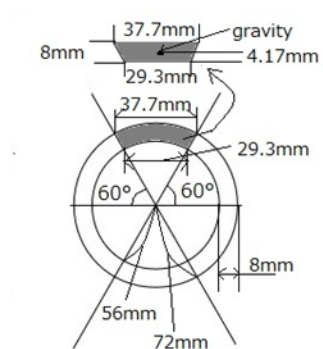

Figure 1: Actual section used to calculate the bending strength (top) and the arched section (bottom)

The dimensions of the bamboo pieces were 72 mm outer diameter, 56 mm inner diameter, and 8 mm thickness. The outer and inner circumferences were 226.1 mm and 175.8 mm, respectively. Since the test specimen is 1/6<sup>th</sup> of the bamboo piece, the outer and inner arc lengths were 37.7 mm and 29.3 mm, respectively. We considered this test specimen to be a trapezoid, wherein the lengths of the outer and inside arcs are equal to the lengths of the long and short bases of the trapezoid, respectively. The cross-sectional area was 267.95 mm<sup>2</sup>, and the distance between the endpoints of the outer arc was 36 mm and that of the inner arc was 28 mm.

Moreover, the distance between the short base and the center of gravity of the trapezoid was 4.17 mm, the area moment of inertia was 1421.84 mm<sup>3</sup> (Futami, 1963), and the intermodal length was 250 mm. In this study, we assumed the load borne by the bamboo section to be a wheel load. Thus, we performed the bending test using a T-load, which is typically used for designing bridges and is a standard in the Road Transport Vehicle Act (RTVA) of Japan.

### 3. RESULTS AND DISCUSSION

The area load of the T-load per wheel is 100 000 mm<sup>2</sup> (Nakai and Kitada, 2003), whereas the wheel load is 49 kN, as per the RTVA of Japan (Figure 2). Therefore, the ground pressure, where the node is considered as the fulcrum, can be given as follows:

$$49\,000 \div (200 \times 500) = 0.49 \text{ (N/mm}^2\text{)}$$

Therefore, the bending moment resulting from the distributed load (0.49 N/mm<sup>2</sup>) was calculated by assuming the bamboo section to be a 37.7 mm long, 8 mm thick, and 10 mm wide beam, with fulcrums at both ends (Figure 3).

$$M_{\max} = wl^2/8 = 0.49 \times 10 \times 37.7^2 \div 8 = 870.5 \text{ (Nmm)}$$

where  $M_{\max}$  is the maximum bending moment,  $w$  is the distributed load, and  $l$  is the span between the fulcrums at each end of the bamboo sample.

Because the beam section is assumed to be rectangular, its plastic section modulus ( $Z$ ) can be calculated as follows (Futami, 1963):

$$Z = 10 \times 8^2 \div 6 = 106.7 \text{ (mm}^3\text{)}$$

Therefore, the stress resulting from the distributed load is given by:

$$M/Z = 870.5 \div 106.7 = 8.16 \text{ (N/mm}^2\text{)}$$

On the other, the bending moment resulting from the distributed load (0.49 N/mm<sup>2</sup>) was calculated by assuming the bamboo section to be a 250 mm long, 8 mm thick, and 10

mm wide beam, with fulcrums at both ends (Figure 3).

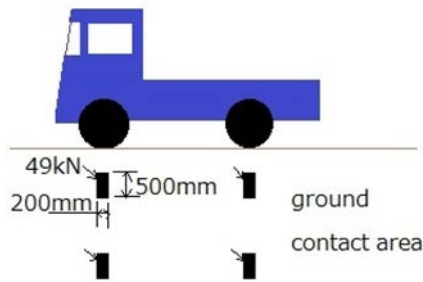

Figure 2. Pressure and ground contact area

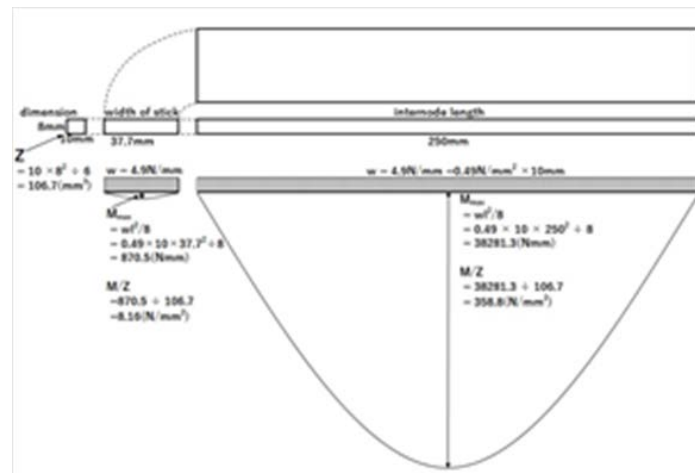

Figure 3: Consideration of maximum bending moment

$$M_{\max} = wl^2/8 = 0.49 \times 10 \times 250^2 \div 8 = 38281.3 \text{ (Nmm)}$$

where  $M_{\max}$  is the maximum bending moment,  $w$  is the distributed load, and  $l$  is the span between the fulcrums at each end of the bamboo sample.

Because the beam section is assumed to be rectangular, its plastic section modulus ( $Z$ ) can be calculated as follows (Futami, 1963):

$$Z = 10 \times 8^2 \div 6 = 106.7 \text{ (mm}^3\text{)}$$

Therefore, the stress resulting from the distributed load is given by:

$$M/Z = 38281.3 \div 106.7 = 358.8 \text{ (N/mm}^2\text{)}$$

Based on the above, we will consider the bending moment when the internode length is taken as the span.

To examine bending fracture, we considered a distributed load of  $0.49 \text{ N/mm}^2$  on all sections between both nodes, which act as fulcrums, because the intermodal length is 250 mm and the width of the load plane of the T-load per wheel is 500 mm. If three or more fulcrums are present in the beam, more complex calculations are necessary because the system becomes statically indeterminate. At present, the test specimen is considered as a simple beam (Figure 4).

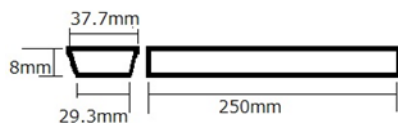

Figure 4: Beam as a test specimen, with the internode as the span

The area of the outer surface is the product of the long base length and the internodal length. Thus, when a wheel load is applied, the distributed load  $w$  is given by:

$$0.49 \text{ (N/mm}^2\text{)} \times 37.7 \text{ (mm)} = 18.5 \text{ (N/mm)}$$

Since the distance between the fulcrums is 250 mm, the maximum bending moment is:

$$M_{\max} = wl^2/8 = 144320.3125 \text{ (Nmm)}$$

Therefore, the maximum bending stress is:

$$My/J \doteq 423.3 \text{ (N/mm}^2\text{)}$$

where  $M$  is the maximum bending moment,  $y$  is the span from neutral plane to further point, and  $J$  is the moment of inertia.

Since 2015, we have conducted outdoor exposure and bending tests of Moso bamboo using 185 buried Moso bamboo sticks, with half the length of the sticks under the soil surface (Photo 4). Every two months, 12 sticks were randomly dug out and each was cut into three sections after cleaning: an upper section, the section around the soil surface, and a lower section. The nodes were then removed and test specimens were prepared for the bending tests (Photo 5). After 1 y of burial, some differences were observed between the MOR of the upper section and those of the other two sections. While the average MOR of the upper section was  $143 \text{ N/mm}^2$ , that of the other sections was  $125 \text{ N/mm}^2$  (Yamaguchi et al., 2017).



Photo 4: Outdoor exposure test site for Moso bamboo sticks



Photo 5: Snapshot of bending test

Reporting on the characteristics of Moso bamboo found in the suburbs of Yokohama

city, Yoshida and Iizuka (2009) found that the average split strength of the stem base section was  $73.9 \text{ N/mm}^2$  six months after harvesting, with an average bending strength of  $123.2 \text{ N/mm}^2$ . Therefore, the split strength is estimated to be approximately 60 % of the bending strength. The split strength of Moso bamboo after 1 y of burial (with no faults in the tested sections) was  $75\sim 85 \text{ N/mm}^2$ .

Hayashi et al. (1999) reported that round holes in a bamboo culm do not affect its bending strength if their diameter is  $<1 \text{ cm}$ . Herein, we assume that the round holes affect the bending strength since their diameters are  $>1 \text{ cm}$ .

Because the maximum wheel load is  $49 \text{ kN}$  in Japan (as per the RTVA ), the ground pressure is calculated as  $0.49 \text{ N/mm}^2$ . The bending stress was  $8.16 \text{ N/mm}^2$  and  $423.3 \text{ N/mm}^2$  when a section of the stick was assumed to be a beam and when the stick was assumed to be a beam, respectively. Thus, we infer that a Moso bamboo stick cannot withstand wheel load and undergoes splitting and bending fracture.

The compressive load applied on the outer surface of the bamboo transforms into tensile stress at its inner surface, which is weaker than the outer surface. The tensile stress induces split and fractures at the weaker points. We thus inferred that the cross drain fractured along the fiber direction.

In 2010, a load test on a bundle of bamboo was performed (Photo 6). The bundles initially yielded to a load of  $50 \text{ kN}$ , after which the load temporarily decreased and cracks occurred in the bamboo sticks. Thereafter, the load increased continuously to over  $100 \text{ kN}$  (Figure 5). Thus, the bundles can withstand the wheel loads of automobiles specified in the RTVA of Japan. However, since the continuous increase in load after yielding of a test specimen is unusual, we re-examined this aspect. The phenomenon of continuous increase in load and strain after yielding of a test specimen, as observed in Figure 5, is similar to that of compression perpendicular to the wood grain (Arima, 1985).



Photo 6: Snapshot of load test of a bundle of bamboo sticks

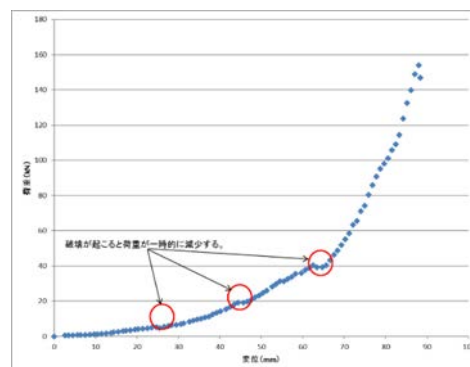

Figure 5. Stress-strain diagram of the compression test (Yamaguchi et al., 2011)

Thus, we assume that the bamboo sticks experienced compressive stress perpendicular to the grain, instead of bending stress, by making contact with each other when a vertical wheel load was applied. Therefore, we propose that wheel loads split the sticks due to tensile stress when a bundle of bamboo sticks is used as a cross drain; the gaps between the sticks appear again after the automobile has passed owing to the bundle elasticity, allowing water to flow through the gaps. Further, we assume that the gaps in the bundle shrink due to insufficient elastic recovery because of a reduction in the bamboo stick strength caused by decay, ultimately resulting in breakage when external forces are applied to the wood (Fukuda, 2005).

#### **4. CONCLUSIONS**

We constructed experimental drainage systems made of Moso bamboo, which is being increasingly used because of its preponderance in Japanese forests. Two different approaches were employed: (1) strips of Moso bamboo were bundled and used as a cross drain, and (2) a Moso bamboo culm, which was too thick and hard to be cut into strips, was used after removing the nodes and drilling holes into it. Notably, the thick and hard bamboo culm broke after 6 months because of traffic, whereas the bundle of stripped bamboo did not.

The bending strength of a bamboo stick against wheel load was determined, with the simplifying assumption that the stick sections are trapezoids. The results demonstrate that the Moso bamboo stick could not withstand wheel load, as evidenced by its splitting and bending fracture. Hence, a cross drain made of bundles of Moso bamboo strips was considered, wherein the weak points could be reduced, even upon bending fracture, by bundling several bamboo sticks. It is proposed that bundled Moso bamboo sticks experience compressive stress perpendicular to the grain by making contact with each other when passing automobiles apply vertical wheel loads onto it.

#### **REFERENCES**

- T. Arima (1985) D. strength (Physics of wood. Masami Fushitani. 286pp., Bun'eido Shuppan Co. Ltd., Tokyo.) 141-167. (written in Japanese)
- K. Fukuda (2005) 2.1.7 Changes in timber due to decay (2<sup>nd</sup> edition, Introduction of Wood Preservation Science. Japan Wood Protection Association. 265pp., Japan Wood Protection Association, Tokyo.) 45-47. (written in Japanese)
- H. Futami (1963) Structural dynamics, revised edition. 344pp., Ichigaya Shuppansha Co. Ltd., Tokyo.
- T. Hayashi, S. Kantake, M. Karube, and M. Harada (1999) Effects of Round Holes on Compressive and Bending Strength of Bamboo. *Mokuzai Kogyo* 54(9):420-425.

(written in Japanese)

- H. Nakai and T. Kitada (2003) 2<sup>nd</sup> chapter: Load (1<sup>st</sup> edition, Bridge Engineering. H. Nakai and T. Kitada. 327pp., Kyouritsu Shuppan Co. Ltd., Tokyo.) 18-36. (written in Japanese)
- S. Yamaguchi, H. Suzuki, Y. Tanaka, and S. Ikeda (2010) Making cross drain made with bamboo and their influence for thinning road. Kanto Journal of Forest Research 61:249-252. (written in Japanese)
- S. Yamaguchi, H. Suzuki, Y. Tanaka, H. Ido, H. Kato, H. Nagao, and S. Ikeda (2011) Strength against pressure of cross drain made with bamboo. Kanto Journal of Forest Research 62:239-242. (written in Japanese)
- S. Yamaguchi, H. Ido, T. Shibusawa, H. Kato, H. Nagao, H. Suzuki, H. Muneoka, Y. Tanaka, and M. Jinkawa (2017) Bending test of Moso bamboo (*Phyllostachys heterocycla f. pubescens*) split and exposed – changes in a year. Abstracts of the 67<sup>th</sup> Annual Meeting of Japan Wood Research Society: N18-P2-19. (written in Japanese)
- K. Yoshida and S. Iizuka (2009) Material Characteristics of Bamboo in Yokohama City Area. Bulletin Of Tokyo Institute, Polytechnic University 23:115-124 (online, <http://www.uitec.ac.jp/images/journal/23-18.pdf>).

## P-15

### Evolution of Forest Harvesting in Peninsular Malaysia

Mohd Hasmadi, I<sup>1,\*</sup> and Pakhriazad, H.Z.<sup>2</sup>

<sup>1</sup> Head, Department of Forest Production, Faculty of Forestry, Universiti Putra Malaysia, 43400 UPM, Serdang Selangor, Malaysia

<sup>2</sup> Department of Forest Management, Faculty of Forestry, Universiti Putra Malaysia, 43400 UPM, Serdang Selangor, Malaysia

\*Corresponding author: Tel: + 603-89467220 E-mail: mhasmadi@upm.edu.my

**Abstract:** Malaysia has been practicing Sustainable Forest Management (SFM) since 1901. After a few systems in 1978, Malaysian forest is managed under sustainable forest management by adopting Selective Management System practices that consider reduced impact logging and Malaysian Criteria and Indicator to meet international requirement and forest certification. In order to archive the sustainable forest management (SFM), an effort have been made to develop a method in forest harvest operation whereas conventional logging has been transform to RIL practices and application of geoinformatic technology. The Forestry Department Peninsular Malaysia (FDPM) has adopted geoinformatics technology for forestry in early 1997 as suggested during Seventh Malaysia Plan. This paper attempts to discuss the evolution phases in forest management and harvest operation, and the way forward of the forest operation in Peninsular Malaysia.

**Keywords:** Malaysian forest, forest harvest operation, sustainable forest management

#### 1. INTRODUCTION

Malaysia has been practicing Sustainable Forest Management (SFM) since 1901. In 1978, Malaysia has adopted the Selective Management System (SMS) with a 30 years rotation cycle to replace the Malayan Uniform System with a 50 years rotation cycle. Now SMS is the main forest management system in Malaysia. Forest harvesting is an important in forest management. Forest harvesting includes all the activities from felling trees and remove them from the forest to the roadside for loading, then transporting them from the forest. Harvest operations in tropical forests are unique compared to temperate forest. In tropical areas the operation conditions is hot, high humidity, high intensity of rainfall and lack of rock for road surfacing. The overall



harvesting of timber in Malaysia subjected to each state's stipulated quota (annual allowable cut) by the respective states. The SMS practiced has evolved to optimize an economic cut, the sustainability of the forests and minimum cost for forest development.

The timber sector in Malaysia is one of the main contributor to the national economy. Generally, a sum of RM 30 billion has contributed to the national economy, of which 70% are from exports (MTIB, 2015). Forest harvesting in the inland forest in Peninsular Malaysia is generally carried out by a combination of crawler tractor-winch lorry and RIMBAKA timber harvester. Currently, reduced impact logging (ground skidding) is also being carried out in Malaysia, while low impact logging (helicopter logging) is being carried out in Sarawak and Sabah. In early economic development after World War II in the late nineteenth has pushing the conversion of forests into plantations, mines and land developments. At the same time, rapid activities occur in forest engineering. During this phase, forest were harvest, burned and exploited due to road construction and communication, establishing the residential area for increment of social life, and construction of dams for example this Kenyir Dam (Anon, 2008) have floating about 36,900 ha of forest area for hydroelectric project propose at Terengganu state. The keys success of the sustainable forest management is a science and engineering in forest harvest operation. The objective of this paper is to discuss the evolution phases in forest harvesting and the way forward of the forest operation in Peninsular Malaysia.

## **2. FOREST RESOURCES: AN OVERVIEW**

FAO (2012) reported that at the end of 2012, Malaysia had an estimated about 20,456,000 ha or 61.7% of its total land area. Of this total, about 8.8% (1,807,000 ha) have been designated as the primary forest, the most rich in biodiversity and carbon-dense forest under sustainable management. Malaysia's forests contain 3,212 million metric tons of carbon in living forest biomass. Malaysia had about 1,807,000 ha of planted forest. The total extent of the Permanent Reserved Forest by forest type in Peninsular Malaysia is showing in Table 1.

The natural forests have been a source of commercial timber for the last two centuries. The projection from the National Timber Industry Policy (NATIP) 2009-2020 the source of our country timbers for the forestry industry not experiencing any shortage. This is because the Malaysian government has implemented the planning of project to develop the area of forest plantations covering 375,000 hectares by 2020. Through this project planning, raw materials related to the forestry industry will have a guarantee supply lasting for a long time. This plan anticipates that the cultivation of 25,000

hectares per year for the next 15 years will be able to promote the project. It is expected that by the end of implementation period in 2020, the annual export of timber and timber based products will reach RM53 billion (Ministry of Plantation Industries and Commodities Malaysia, 2009). Figure 1 showing the future timber product that will be harvest result according to the policy.

Table 1. Permanent Reserved Forest area by forest types in Peninsular Malaysia, 2016 (ha)

State	Inland Forest	Peat Swamp Forest	Mangrove Forest	Forest Plantation	Total Area
Johor	318,718	3,796	31,915	60,199	414,628
Kedah	326,192	-	6,201	9,583	341,976
Kelantan	468,595	-	-	166,842	635,437
Melaka	5,002	-	135	-	5,137
Negeri Sembilan	152,549	-	101	3,000	155,650
Pahang	1,326,679	140,830	2,416	89,988	1,559,913
Perak	899,092	-	43,878	56,503	999,473
Perlis	10,128	-	-	671	10,799
Pulau Pinang	5,015	-	1,045	-	6,060
Selangor	136,860	82,890	18,998	11,381	250,129
Terengganu	514,082	25,931	1,037	3,883	544,883
Wilayah Persekutuan*	63	-	-	-	68
<b>TOTAL</b>	<b>4,162,980</b>	<b>253,447</b>	<b>105,726</b>	<b>402,000</b>	<b>4,924,153</b>

\*Total areas including Federal Territory Kuala Lumpur, Labuan and Putrajaya. (Source, FDPM. 2016)

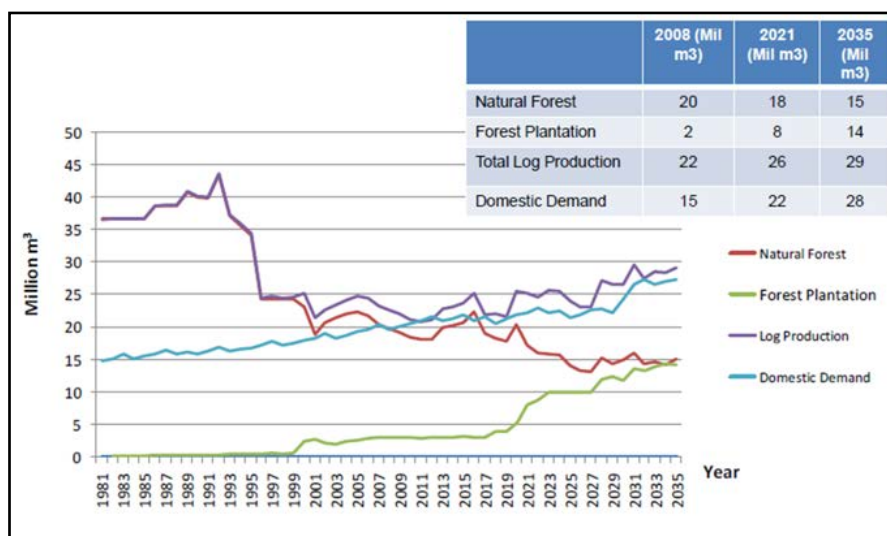

Figure 1. The projection of future timber product according to National Timber Industry Policy (NATIP), Malaysia

Although Malaysian government already has planned well for the future, but the challenges our nation is facing right now is in terms of raw material supply from the natural forests as certainly we are suffer from shortages. Reason that lead to this problem is because of the trees in the natural forests requires a long time to grow and mature. In addition, most of the loggers did not apply the practices of replanting of the seedlings after harvesting in the natural forest. This leads to the continuous declining in regenerating the number of trees in the natural forest. Due to these circumstances, the government carries out a project to expand forest plantation in order to address the issue of shortage of raw materials. The projected average annual log production from natural forest 2006-2020 in P. Malaysia is showing in Table 2.

Table 2. Projected average annual log production from natural forest 2006-2020 in P. Malaysia

Five Year Period	Million m3
2006-2010	3.8
2011-2-015	3.0
2016-2020	2.5
<i>Source: JPSM, JPS, JHS and NRE</i>	

From 2006-2020 the State Forestry Department optimist that the average annual production of the log from plantations will be increased within five year period. The

timber production from the forests plantations increasing due to the management that have been applied on the forests as it is easier for the forests plantations to be managed and monitored.

### 3. FOREST ADMINISTRATION AND MANAGEMENT

The administration of forest in Peninsular Malaysia is divided into three levels, namely the Federal, State and district levels. Each state has its own forestry Department headed by the State Director of Forestry. Under Malaysian constitutional provisions article 74(2), forestry is under the authority of the respective State Governments. At the state level, the State Director of Forestry is usually assisted by two Deputy Directors (Forest Development and Forest Operation) and other officers, namely Forest Management Officer and Silvicultural Officer. The District Forest Officers report directly to the State Director of Forestry. The state forestry department is responsible for the implementation of the forest policies of the state. At the Federal level, the Director General responsible to give technical advice to the state forestry departments as well as policy advice to the federal government.

In ensuring the continuous supply of logs, forests are managed systematically. Such forest management systems were applied with the aim of optimizing timber yield and quality from the forests and of improving the regenerating capacity of stands of commercially valuable species (Wan Razali and Shahwahid, 2011). In the early era of forestry the system is governed by British where the main concern was to ensure timber resources used mainly for ship building and construction of railways (Ratnasingam and Ioras, 2006). Since then, the chronological or timeline of forest management systems in P. Malaysia has change as presented in Figure 2.

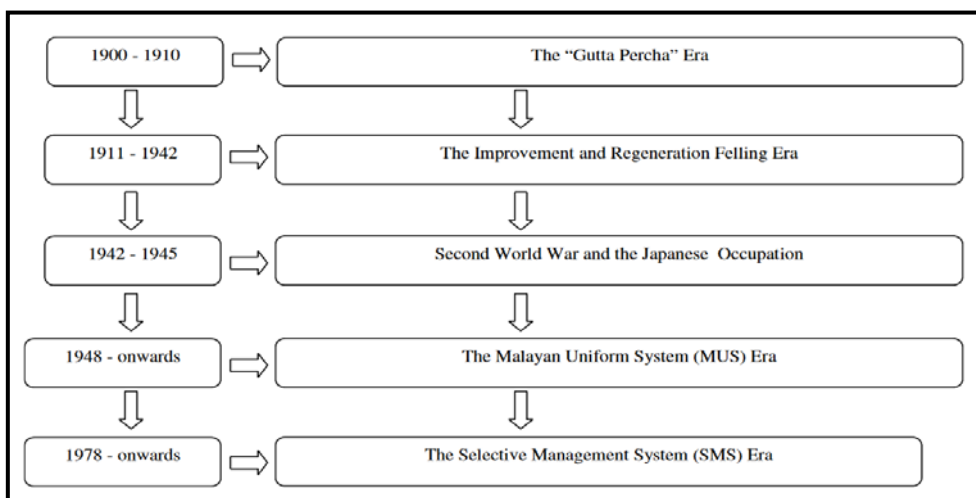

Figure 2. Timeline of forest management systems in P. Malaysia

Hooi (1987) reported that during the colonial period, forest resources were used excessively under the management called “Gutta Percha” Era (1900-1910) and the Improvement and Regeneration Felling Era (1911-1942). The Malayan Uniform System (MUS) was initiated to manage the forest due to the high demand for raw materials at domestic and international level. During the Malayan Uniform System a new forest system was introduced as well, known as the Selective Management System.

#### **4. ORIGINS OF FOREST OPERATION IN MALAYSIA**

Historically, the first recorded harvesting activity in P. Malaysia is in era 1900-1910 known as “*gutta percha*” era (Wyatt-Smith, 1954; Barnard, 1954), as shown in Figure 3. Gutta-percha is a name derived from “getah” –meaning gum and “pertja” the name of tree in Malay. The gum was used in crude form by the native Malaysian and archipelago for making knife, walking stick and for various purposes such as conductors of heat and electricity. It is used in electrical, surgical and dental apparatus, but one of the most important uses was in the coating of submarine cables. Gutta percha is derived from the latex of various species of *Palaquium*. Many species produced such latex, but the best quality is known as *getah taban merah* and is derived from the trees of *Palaquium gutta*.

Since the appointment of the first chief forest officer and the establishment of the Forestry Department in 1901, Malaya (now Malaysia after gaining independence in 1957) has made marked progress in forest management. Commercial forest harvesting in P. Malaysia began as a socioeconomic concept. Traditionally, timber harvesting operations were based on a system of manual felling and bucking, with the use of animal such as buffalo for land transport. Such practices were used all over Southeast Asia for centuries.



Figure 3. *Gutta-percha* era; A man drew out latex from the tree.  
(Source: Forestry Department Peninsular Malaysia, 2001)

Forest operation origins in Peninsular Malaysia is a good example illustrates the changes of the involvement of multi disciplines inputs in the forest management. Forest harvesting in general involves three stages namely pre-harvesting, during harvesting and post-harvesting activities. The pre-harvest involves demarcation of boundary, pre-felling inventory, determination of cutting limits and timber tagging. During harvesting it involves road construction and directional felling, timber transportations while post-harvesting activities includes preparation of closing report which includes post-harvest assessment, post-felling inventory and prescription of silvicultural treatments. Table 3 presented the overview of forest management and timber harvesting development in Peninsular Malaysia.

Drawn back in 1900-1935, logging equipment and methods were using axes, hammer, wedge and handsaw, and logs are transported out by animals such buffaloes and elephants (Figure 4). In the East Coast P. Malaysia, rivers were used for logs transportation and it was a cheaper method of moving logs in large quantities. In mangrove forest, log was transported by boat through man-made canals and parallel rivers (Figure 5). Meanwhile in peat swamp forest, the *panglong* or *kuda-kuda* system was installed (Figure 6). Sometimes, logs are floated out directly to log landings or mill sites since motor vehicles and animals cannot possibly trudge the peat soil (Norizah et al, 2011).

Table 3. Overview of forest management and harvesting practices in P. Malaysia

Period	Management concept	Logging methods and equipment	Main projects
Before 1900 (Wyatt-Smith, 1954; Kamaruzaman and Nik Mohamad Shah, 1994; FDPM, 2001)	<i>Gutta-percha</i> era (uncontrolled selective logging)	Manual felling; axe, handsaw	Gutta percha rubber estate
1900 – 1922 (Wyatt-Smith <i>et al.</i> , 1997; Kamaruzaman and Nik Mohamad Shah, 1994; FDPM, 2001)	Departmental Improvement Felling (DIF)	Manual felling and animal transport; axe, handsaw	Cover heavy hardwood species (e.g: <i>Neobalanocarpus heimii</i> )
1922-1935 (Wyatt-Smith, 1954; FDPM, 2001)	Commercial Regeneration Felling (CRF)	Manual felling and animal transport; axe, handsaw	Firewood harvesting
1927 (Wyatt-Smith <i>et al.</i> , 1997; Kamaruzaman and Nik Mohamad Shah, 1994; FDPM, 2001)	Regeneration Improvement Felling (RIF)	Manual felling and animal transport; axe, handsaw	Remove un-commercial tree value (about 5 years before logging)
1945 – 1978 (Kamaruzaman and Nik Mohamad Shah, 1994; FDPM, 2001; FDPM, 2003a)	Malayan Uniform System (MUS)	Manual felling and 'San Tai Wong'; axe, chainsaw, tractor, crawler	Logging concession exploitation
After 1978 – onwards (UNDP & FAO, 1978; Schmidh, 1987; Kamaruzaman and Nik Mohamad Shah, 1994; FDPM, 2003a)	Selective Management System (SMS) Reduce Impact Logging (RIL)	Manual felling and mechanised transport; powersaw, skidder, bulldozers, trucks	Forest plantation, timber complex
After 2000 – onwards (Alastair, 2001; Mohd Hasmadi and Norizah, 2010; FDPM, 2010)	Selective Management System (SMS) Reduce Impact Logging (RIL)	Manual felling and mechanised transport; powersaw, skidder, bulldozers, trucks RIMBAKA	Forest plantation, Logging concession, Dipterocarp forest, Peat swamp forest, Forest management unit, RIL

(Source: Norizah et al., 2011)

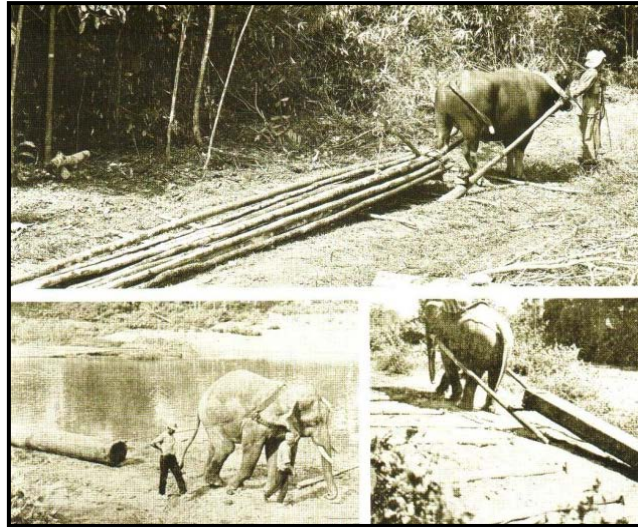

Figure 4. Cows and buffaloes were used to transport logs around 1930's  
(Source: Forestry Department Peninsular Malaysia, 2001).



Figure 5. Extracting logs through man-made canal at a peat swamp forest  
(Source: Forestry Department Peninsular Malaysia, 2001).



Figure 6. Pulling log using *kuda-kuda* system in 1963 in peat swamp forest.  
(Source: Forestry Department Peninsular Malaysia, 2001).



## 5. RESEARCH IN FOREST OPERATION

In P. Malaysia, forest harvesting operation generally carried out by ground based system. Under this system the crawler tractor skids the logs from the felling sites to the skid trails where the winch lorry continues the transportation to the roadside landings or temporary log yards. Eco-friendly timber harvesting techniques are essential for successful of sustainable forest management (SMS). Therefore, research on reduced impact logging (RIL) has been intensified with particular attention being given to improving the technologies in harvesting.

The Ecologically Friendly Logging System (ECOLOG) and Mobile Tower Yarder (MTY) system have been tested for RIL practices (Shamsudin *et al.*, 1999). The use of these method aim to minimize the impact to forest area especially ground surface resulted from log extraction and reduce the damage to residual trees. For instance, ECOLOG was operated with 800 m long wire rope and one cone whereas it was fixed at the front of the log to facilitate the winching process and at the same time protecting the forest floor from disturbance and preventing the residual tree (Figure 7). Study by Wan Mohd and Mohd Paiz (2003) on ECOLOG harvesting showed that about 69.3 % of the residual trees survived compared to conventional harvesting which only 47.3 %. The differences between both systems are clearly showed that ECOLOG exhibit better environment to residuals stand compared to conventional harvesting. Damages to the soil are also less by the ECOLOG harvesting as on average bulk density measured only  $1.1 \text{ g cm}^{-3}$ , while conventional harvesting was  $1.5 \text{ g cm}^{-3}$ . In the other hand, soil moisture content are proven more moist with ECOLOG where 8 % more moist than conventional harvesting.



Figure 7. An ECOLOG fiberglass cone fixed in front of log to assist hauling process.

Another systems studied was the Ryoshin mobile tower yarder (MTY). The MTY is a highly efficient system that can operate at distances of up to 200 m - 500 m working

area (Figure 8). One advantage of the MTY is the yarding system is ease to set up and operated, and reducing labour requirements. It can be used for uphill, downhill and lateral yarding. The Ryoshin type RME500 T.M was designed by Oikawa Motor Company was sent to Malaysia for a collaborative study between Japan Information Research Centre for Agriculture (JIRCAS), FRIM and Kumpulan Pengurusan Kayu Kayan Terengganu (KPKKT), Malaysia. Azman *et al.* (1999) reported that from their study in, Jengai Forest Reserve, Terengganu the density of corridor is significantly lower than the maximum allowable density of 300 m ha<sup>-1</sup> as specified by forestry department. Obviously, study from both harvesting machineries was proven less density of skid trail constructed on the timber harvesting site.



Figure 8. Mobile Tower Yarder (MTY) operated in Jengai Forest Reserve, Terengganu.

The first machinery introduced for efficient timber harvesting in Peninsular Malaysia began since the 1920's as the shortage of animal extraction (FAO, 1973). The four-wheeled vehicle with three-ton weight was operated with the end of the log choked by the winch. As development of machinery, highly versatile machines were introduced which were capable of extracting the log directly from the stump. With forest road construction, more machinery was introduced, for example the Caterpillar D6 tractor, which proven to reduce the cost of productivity compared to extraction by animal. Then the rubber-tired wheeled skidder was introduced in 1968 for the first horse power model; 120/130 and the modified skidder with 180/190 horse power model was introduced then in 1969. In the 1970's the demand for wood production and timber export were increased, then new technology needed to be introduced in timber harvesting operations (Wang, 1997).

Mechanized harvesting systems have an important role in forest harvest operations to

ensure the production of timber available efficiently. The use of machinery for road construction and timber extraction resulted several impacts to forest stand whether practiced by high performance machine. For example, the employment of crawler tractor is not simply for forest road construction purpose, but it also operated to skid the logs from felling site while winch lorry will continues the transportation to the roadside landings. Thus, maximum soil disturbance are expected from the combination of several machineries used in harvesting operation as there are freely moving in the forest (Wan Mohd and Mohd Paiz, 2003).

In 2001, RIMBAKA R2020-A machine was used (Figure 9). This machine is proven in minimizing environmental impact and also does not require go to felling site as this machinery enable to extract harvested timber only from feeder road (Alastair, 2001). Study by Mohd Hasmadi and Norizah (2010), between the Rimbaka harvester and crawler tractor namely KOMATSU D60-A, the total passes of both machinery show the significant difference. In comparison the shoe size of RIMBAKA is bigger (80 cm) than crawler tractor (51 cm). By the size matter RIMBAKA results more affected to soil compaction. However, this machine is operating without skid trail thus reduce road density in forest. A previous study by Osman (2009) found that RIMBAKA has showed lesser amounts of soil disturbance and reduced pollution to water quality compared to the conventional method. Furthermore the pollution is much lower when the harvesting operation is carry out during dry season. RIMBAKA has been accepted as an ideal alternative to support RIL system like skyline, mobile tower yarder and helicopter.

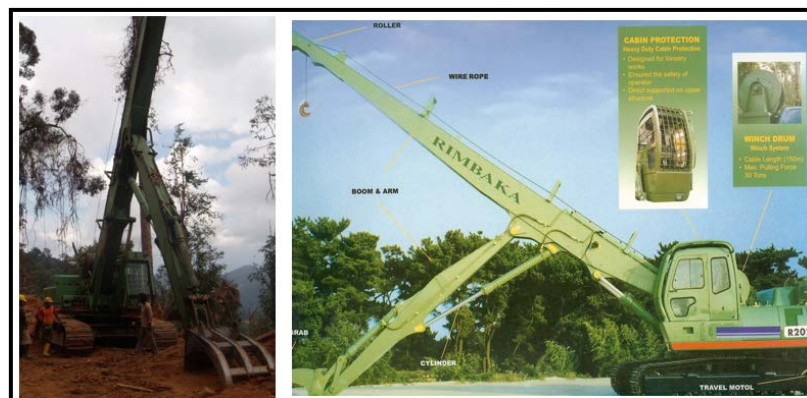

Figure 9. “Environmental friendly” RIMBAKA R2020-A Timber Harvester System operating in hill dipterocarp forest.

### 5.1 The use of geoinformatic technology in forest harvest operation

Geoinformatic technology has been emerged as essential tools for many areas include harvest operation. The emerging of geospatial science offers a new dimension in forest

harvest operation and research worldwide. Since 1988 Malaysia took a challenge from the advance geospatial technology for managing her forest. Several studies have been conducted with the uses of geoinformatics technologies in timber harvesting and operation in Malaysia including forest road network construction (Shamsul, 1999; Judibal, 2000; Khali, 2001; Musa and Mohamed, 2001; Mohd Hasmadi and Taylor, 2008; Mohd Hasmadi and Kamaruzaman, 2009; Mohd Hasmadi *et al.*, 2010). Moreover, the applications of GIS and remote sensing in monitoring forest resources have been suggested in Seventh Malaysia Plan in 1996.

A study by Musa and Mohamed (2001) shows that GIS is helpful in selecting suitable forest roads in the hill tropical forest. The study in Ulu Muda Forest Reserve, Kedah, Malaysia. Indicated that road alignment can be determined using GIS technique which enable forest harvesting be carried out with minimum environmental disturbances. The extended study on forest road was studied by Mohd Hasmadi and Kamaruzaman (2009). The study used computer based remote sensing-GIS methods with spatial modelling to allocate road networks in hilly forest. The combination of GIS, remote sensing data and best path modelling an automatic alignment of the road can be generated (Figure 10). The study reported that the density of proposed road is only  $9.93 \text{ m ha}^{-1}$  (0.80%). The road allocation model is useful to assist the planners and foresters in the planning and design stages for establishing an optimum forest road for forest harvest operation. On the other hand, the optimum forest road also can help mitigate the loss of ecological services of tropical forest subject to logging pressure and lead to greater financial benefit in future operations. Technology such as remote sensing and GIS can potentially be used in forest engineering operation and research due to cost-effectiveness.

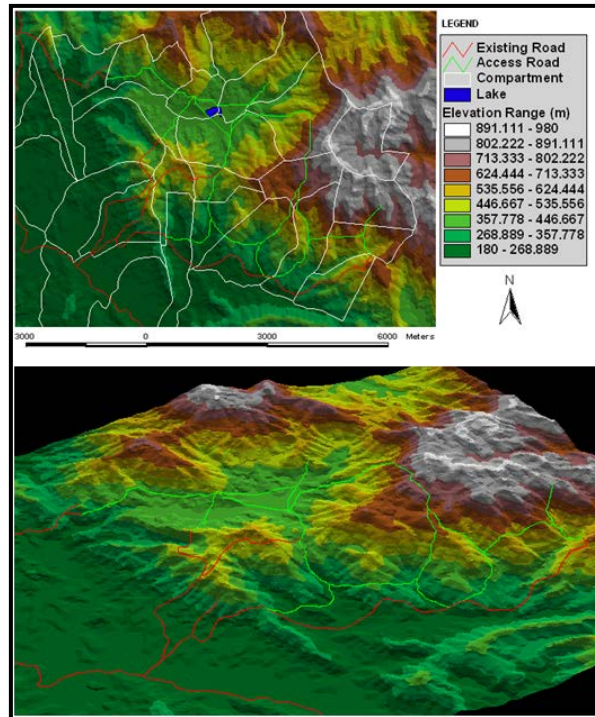

Figure 10. Pre-pelan access road from 3D view using remote sensing and GIS.

Pre-harvesting work such as directional felling is practised by forestry department in Malaysia as prescribed in *Manual Kerja Luar: Sistem Pengurusan Memilih (SMS)* 1997. The task to determine the direction felling is conducted during the pre-felling inventory. Felling direction should be nearest to skid trail, which reduces the distance, and trees should be fell within  $10^\circ$  of felling angle direction. Rhyma (2014) has carried out a study to predict the direction of tree felling using GIS-vector based. A path distance back link function in ArcMap was used in predicting tree felling. Meanwhile a binary classification was used to compare between the felling direction estimated by using GIS and tree felling direction observed on ground. Results showed that about 61.3 % from 31 trees predicted by using vector based projection method were similar to the felling direction which observed on ground. Figure 11 shows the example of the estimated direction of tree fall towards skid trail with high mitigation measures which in range 0.5. This study achieves 61 % accuracy when compared to the real site.

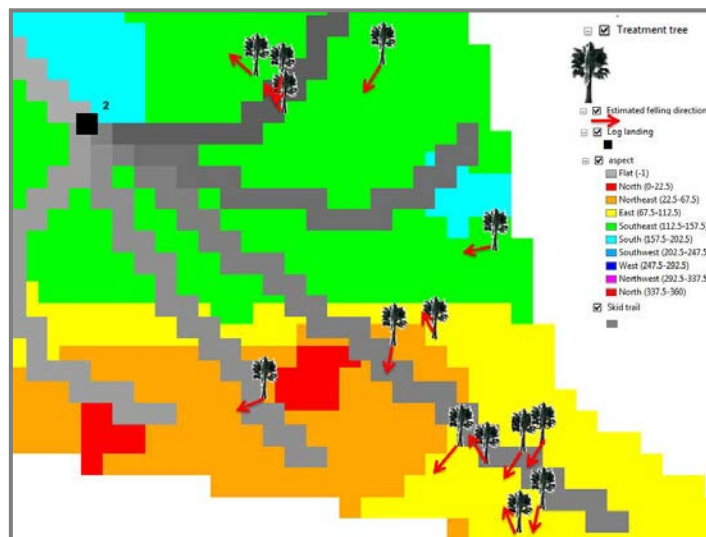

Figure 11. Estimated tree fall toward skid trail with high mitigation measures range 0.5.

## 6. NEXT STEPS

Forest harvest operation today was drastically occur with the main purpose to meets the human needs for social, economic and environmentally concern. Malaysia, generally, have through the forest operation activity since the early 19<sup>th</sup> centuries in order to make the forest products available sustainably. The challenges in next future years is paying attention towards the environmental issue such as how forest harvesting can cause the climate change. Therefore, to avoid the environment from getting worse, there is few immediate actions had to consider ensuring the sustainability of the forest resources meet the objective. The actions is needs to improve the harvest system and reforestation technologies in operational studies. Promoting the the optimal use of a wider range of timber species especially the under-utilised species is a major concern in order to reduce wastage from harvest operation.

Forestry will remain as a central focal point whether regionally or internationally initiatives. In regard to attain the ultimate goals of SFM concept forest resource must be viewed and addressed holistically. In future, computerized methods are very useful in the solution to forest operation engineering which regard to harvesting. With increasingly strict standards in forest operation the computerized decision support system is consider as an alternative values. The forestry manager must face an increasingly complex planning process for its forest. Decision making is paramount in forest harvest planning. Computerized decision-support systems through geoinformatics engineering have already become operational tools that greatly facilitate the management of forest resources. Therefore forest manager must be capable in decision making process that extend beyond a strictly forestry context. Noteworthy changes in

forestry operations today urge the forestry sector prepare itself to the next steps and ensures the necessary research and development efforts is undertaken.

## **7. CONCLUSIONS**

Peninsular Malaysia has benefited tremendously from her forest resources since 1900. The rich diversity of the forests has contributed direct economic benefits derived from timber products and other non-timber forest produce. The future of forest harvesting is being planned well by the government as forest production is one of the main contributors towards the nation's economy. Although the forest plantation is expanding by the year 2020 but the natural forest will be protected. Forest harvest operation is continues in reserve forest by strictly guideline. The use of geoinformatics technology in forest operation and more friendly machinery is worth to achieve SFM. More studies should be undertaken for better understand the usability of forest engineering and operation in forestry.

## **REFERENCES**

- Alastair, S. (2001). A locally developed log-extraction technique is reducing damage to the peat swamp forests of Peninsular Malaysia. ITTO Tropical Forest Update, 11(2), Yokohama, Japan.
- Anon. (2008). Pembalakan dalam air di Tasik Kenyir. Pejabat Hutan Daerah Terengganu Barat, Kuala Terengganu. Forest Department of Terengganu State. 10p.
- Azman, H., Sasaki, S. and Yamada, T. (1999). Harvesting timber using mobile skyline yarder reduces impacts on forest environment: preliminary finding, ed. Sahmsudin, I., Nur Hajar, Z.S. and Choon, K.K. Proceeding of the Tropical Forest Harvesting: New Technologies Examined. Primula Parkroyal Hotel, Terengganu, 22-24 November 1999. pp 178-185.
- Barnard, R.C (1954) A manual of Malaysian Silviculture for inland lowland forest. Research. Pamphlet No. 14, Forest Department of Peninsular Malaysia, 199p
- FAO.(2012). Global Forest Resources Assessment 2012.Rome Italy.
- FAO (1973). Logging and log transportation in Peninsular Malaysia. Food and Agricultural Organization of United Nation, Rome, Italy.
- Hooi, C.T (1987). Forest management systems for tropical high forest, with special reference to Peninsular Malaysia. Forest Ecology and Management 21:3-20.
- Judibal, C.C. (2000). GIS-based support system for tactical timber Harvesting Planning; Designing and Development. Ph.D (Thesis), Universiti Putra Malaysia, Serdang, Selangor, Malaysia. 174p.
- Khali, A.H. (2001). Remote Sensing, GIS and GPS as a tool to Support Precision

- Forestry Practices in Malaysia. Paper presented in 22<sup>nd</sup> Asian Conference on Remote Sensing: Singapore. 5-9 November 2001.
- Ministry of Plantation Industries and Commodities Malaysia (2009). National Timber Industry Policy. 142p.
- Mohd Hasmadi, I. and Kamaruzaman, J. (2009). Planning of access road using satellite technology and best path modeling. *Journal of Modern Applied Science*, 3(3): 83-95.
- Mohd Hasmadi, I. and Norizah, K. (2010). Soil disturbance from different mechanized harvesting in hill tropical forest, Peninsular Malaysia. *Journal of Environmental Science and Engineering*, 4(1): 34-41.
- Mohd. Hasmadi, I., Kamaruzaman, J. and Muhamad Azizon, J. (2008). Forest road assessment in Ulu Muda Forest Reserve of Peninsular Malaysia. *Journal of Modern Applied Science*, 2(3).
- Musa, M.K.A and Mohamed, A.N. (2001). Alignment and locating forest road network by Best-path modelling method. Paper presented at the seminar “Teknologi Remote Sensing dan GIS dalam Aplikasi Perhutanan”, Kuala Lumpur, 31 July 2001. Pp. 13
- Norizah, K. (2008). Developing new forest class by fusing vegetation and lithology characteristics at Southern Johore using Geographic Information System (GIS). B. For. Sc. Thesis, Faculty of Forestry, Universiti Putra Malaysia. 74p.
- Norizah, K., Mohd Hasmadi, I., Kamaruzaman, J. and Alias, M.S. (2011). Evolution and Development of Forest Harvesting in Peninsular Malaysia. *Malaysian Forester*, 74 (2): 79-102 (2011)
- Ratnasingam J., and Ioras, F. (2006). Colonial British Forestry in Malaysia and the Years Thereafter. Colorcom Grafik Sistem Sdn. Bhd., Malaysia
- Rhyma, P.P. (2014). Predicting Tree Felling Direction Using GIS. B.Sc Thesis, Faculty of Forestry, Universiti Putra Malaysia. 74p
- Shamsul, S. (1999). Geographical Information System for forest road planning: A case study of Balah Forest Reserve, Ulu Kelantan. Bac. Sc. (Thesis), Faculty of Forestry, Universiti Putra Malaysia, Serdang, Selangor, Malaysia. 71p.
- Mohd Hasmadi, I. and Kamaruzaman, J. (2009). Planning of access road using satellite technology and best path modeling. *Journal of Modern Applied Science*, 3(3): 83-95.
- Mohd Hasmadi, I. and Taylor, J.C. (2008). Sensitivity analysis of an optimal access road location in hilly forest area: A GIS approach. *American J. Applied Sciences*, 5(12):1686-1692.
- Mohd Hasmadi, I., Pakhriazad, H.Z. and Mohamad Farhan, S. 2010. GIS-Allocation Model for Forest Path: A case Study in Ayer Hitam Forest Reserve, Malaysia. *American J. of Applied Sciences*, 7(3): 376-380.
- The Malaysian Timber Industry Board (2015). Taken



from [http://www.mtib.gov.my/index.php?option=com\\_content&view=article&id=94](http://www.mtib.gov.my/index.php?option=com_content&view=article&id=94)  
Accessed on May 2017

- Wan Mohd,S.W.A. and Mohd Paiz,K. (2003). Alternatives reduced impact logging techniques in Peninsular Malaysia. Proceeding of International Expert Meeting on the Development and Implementation of National Codes of Practices for Forest Harvesting- Issues and Options.13p.
- Wan Razali, W.M. and Mohd Shahwahid, H.O. (2011). Transitions to sustainable forest management and rehabilitation in Malaysia. [www.apafri.org/activities/Forest%20Transitions/reports/Malaysia.pdf](http://www.apafri.org/activities/Forest%20Transitions/reports/Malaysia.pdf).  
Accessed on May 2017
- Wang, L. (1997). Assessment of animal skidding and ground machine skidding under mountain conditions. *Journal of Forest Engineering*, 8(2): 57-64.
- Wyatt-Smith, D.M. (1954). A manual of Malayan silviculture for inland lowland forest No.16. In *Research Pamphlet*, ed. R.C. Barnard and M.A. Cantab. Forest Research Institute, Forest Department Federation of Malaysia.199p.

## P-16

### **Trend of Charcoal Production from Year 2000 To 2013 from Mangrove Forest Reserve, State of Perak, Malaysia**

Nor Azmi, B.<sup>1\*</sup>, Pakhriazad, H.Z.<sup>1</sup>, Mohd Hasmadi, I.<sup>2</sup>, Md. Damiri, M.S.<sup>1</sup>, Wan Nur Farinie, W.Z.<sup>1</sup>, Nur Syuhada, N.<sup>1</sup>, and Nur Afifah, M.A.<sup>1</sup>

<sup>1</sup>Department of Forest Management, Faculty of Forestry, Universiti Putra Malaysia, 43400 UPM, Serdang, Selangor Malaysia

<sup>2</sup>Department of Forest Production, Faculty of Forestry, Universiti Putra Malaysia, 43400 UPM, Serdang, Selangor, Malaysia

\*Corresponding author: Tel: +60132993372 E-mail: [mrzmi@ymail.com](mailto:mrzmi@ymail.com)

**Abstract:** Kuala Sepetang is a part of the mangrove forest in Taiping and Larut Matang district, State of Perak, Malaysia. The aim of this paper is to determine trend of charcoal production in Matang Mangrove Forest from year 2000 to 2013. Mangrove forest can be harvested as determined by the Mangrove Forest Management Plan, Perak State Forest Department. The contractor's will be allocated a different area by rotation system and based on a number of kiln owned by the contractors. The study describes factors that influence the production of charcoal. The increasing production of charcoal began in 2004. It is based on local market and export demand. Production for export markets is higher, which was 70% annually compared to the local market. Distribution of charcoal for the local market (Perak, Penang, Kuala Lumpur) shows no significant difference in each year. Total royalty collection of charcoal increased by RM50,668 each year. Meanwhile total of charcoal cess was increased followed by the total of charcoal production and royalty.

**Keywords:** Charcoal production, Mangrove forest, Perak, Malaysia

#### **1. INTRODUCTION**

Mangrove is unique inter-tidal wetland ecosystem found in sheltered tropical and subtropical shores, which receive inputs from regular tidal flushing and freshwater streams and river. It is characterized by high temperature, fluctuating salinity, alternating aerobic and anaerobic conditions, periodically wet and dry, unstable and shifting substratum. Mangrove communities are made up taxonomically diverse groups of plants and animals, and each community has its own distinctive flora and fauna

species.

Matang's mangroves forest covered an area about 106.104 hectares is the largest single mangrove forest in Peninsular Malaysia. Matang mangrove is an exemplary sustainable managed mangrove forest which has been able to sustain the continuing demand for wood resources and protection of the mangrove ecosystem. Mangrove itself is a unique ecosystem which requires special attention and management. Its location which is between the land and the sea plays an important role in fishery production, coastal habitats for specialized trees as well as for many common, threatened and endangered species. Matang is a national heritage and an asset, for it has been a provider of numerous renewable products of commerce and in the continuing generation of economic opportunities for local communities.

These rich ecosystems have over the years provided valuable goods and services both in economic and environmental terms. Mangroves have also been proven to enhance and support coastal fisheries, which is required to sustain social and fishery economic activities (Nik Mohd Shah & Azahar, 2005). In the context of reservation, management and conservation of mangroves one can draw on the invaluable experiences and lessons learned from Matang Mangrove. Matang Mangrove Forest Reserve is perhaps the only large tract of mangroves in the world that is managed on a sustainable basis with timber extraction and fishing activities taking place throughout the year (Sasekumar & Wilkinson, 1994).

Timber produce derived from final felling in Matang Mangroves is primarily being used for the manufacture of charcoal. The continual utilization of the timber for charcoal production is obviously for economic reasons and is fueled by the continuing strong demand especially in the local and export markets. However, the utilization of mangrove timber for firewood is currently limited and localized (Nik Mohd Shah & Azahar, 2005). There are many charcoal makers with 380 kilns in Matang (Azahar & Nik Mohd Shah, 2003). It produced 70% of charcoal from overall Malaysia export of RM 29.7 million, followed by other states such as Kelantan and Sarawak (Spalding et al., 2010).

The data on the trend of charcoal production is insufficient. There is still a lack of information on trends of production by charcoal contractors. This is due to no systematic records about their production. State Forest Department data is not up to date. No systematic compilation and analyses on the trend of charcoal production. Thus, the main objectives of this paper is to determine the trend of charcoal production in Kuala Sepatang, Mangrove Forest Reserve, Perak and to examine the monetary value of charcoal production from 2000 to 2013.

## 2. METHODOLOGY

Field observation was carried out in Kuala Sepetang Mangrove Forest Reserve, Taiping Perak, Kuala Sepetang Matang Mangroves Forest Reserves is located between latitude 4° 15' to 5° 1' N and longitude 100° 2' to 100° 45' E and is a typical revering mangrove forest in Malaysia. (Lim & Mohd Parid, 2000). The mangroves reserve is shaped like a crescent moon along 51.5 km coastline from Kuala Gula in the north to Bagan Panchor in the south. Kuala Sepetang was chosen as the study site because the number of charcoal kilns operators in Kuala Sepetang is higher than in Kuala Trong and Sungai Kerang. The data were analyzed using Microsoft Excel to generate trend line. A trend line represents a trend, with long-term period of data that have been accounted for. It will tells whether a charcoal productions have increased or decreased over the period of time. The line is drawn and calculated by using linear regression.

## 3. RESULTS AND DISCUSSION

### 3.1 Trend of charcoal production

The production over the period 2000 to 2013 (13 years) in tonnes in Kuala Sepetang was tested by regression analysis. Mangrove wood supplied affects the production of charcoal each year. The highest production was in 2009 (26,782.83 tonnes) and the lowest is in 2001 (6,883.35 tonnes). The significant reduction and increasing of trend of charcoal production is shows in Figure 1. The model explains about 83.4 % of information on relation in production and other 28.6% is not been explain the model. The production was increased by 1,437 tonnes each year.

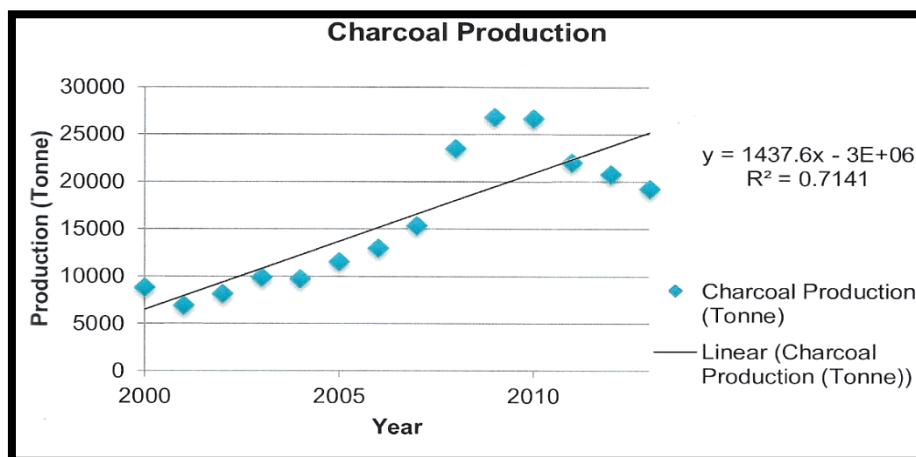

Figure 1 : Trend of Charcoal Production

### 3.2 Total of charcoal royalty

Each kiln required to pay royalty for charcoal produced. Royalty based on the number

kiln operation only. The highest of royalty was in 2011 (RM 744,626.15) followed by the year 2012 (RM 710,660.91), and the lowest was in 2001 (RM 117, 775.92). The significant between reduction and increasing of total of charcoal royalty is shown in Figure 2. The model explain about 86.6% of the information on relation on royalty and other 13.4% not been explain in model. The royalty was increased by RM 50,668.00 each year.

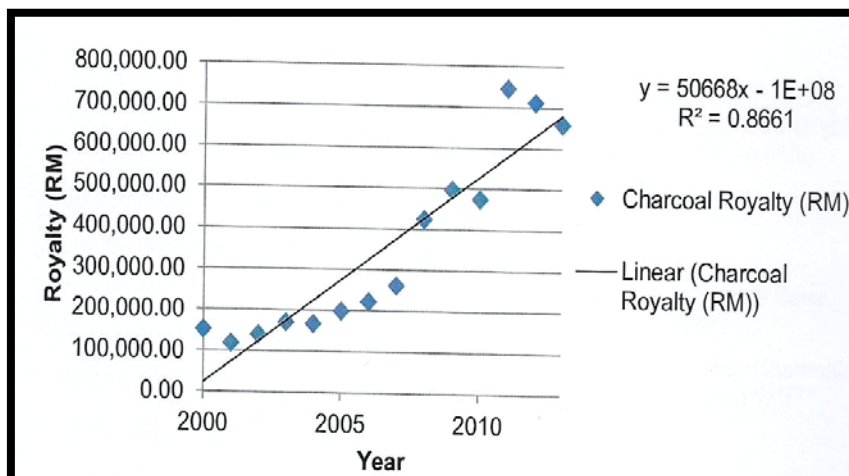

Figure 2 : Charcoal Royalty by Year.

### 3.3 Total of charcoal cess

Cess collected for conserving or replanting mangroves to protect the mangroves from extinction. It is the amount that has been harvested and will be paid by the contractor. Figure 3 shown the total of charcoal cess for 14 years. The highest number of charcoal cess was in 2011 (RM 76,549.74) and the lowest was in 2001 (RM 11, 777.59). The collection is unpredictable because they are an issue on the current price of charcoal. The model explain about 85.8% of the information on relation in cess and other 14.2 is not been explain in the model (Figure 3). The total of charcoal cess was increased by RM 5107 each year.

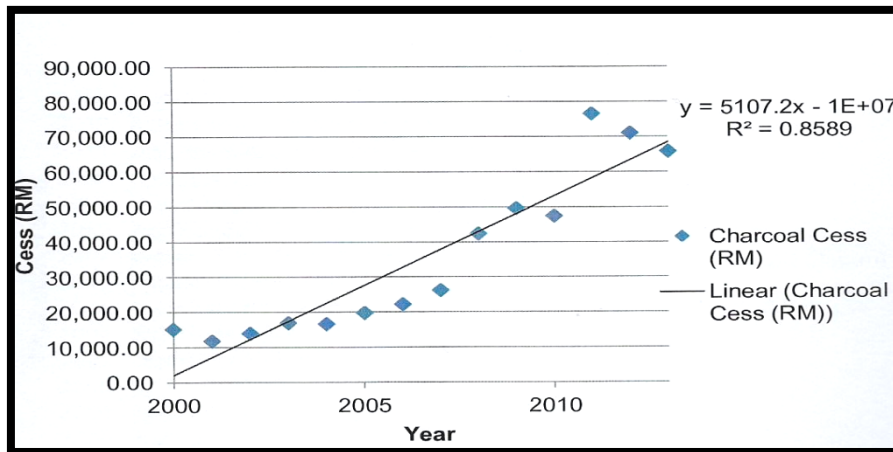

Figure 3 : Charcoal cess by Year.

### 3.4 Market distribution of charcoal production for local and export market.

Charcoal products in Kuala Sepetang are mainly exported to Japan. More than 70% products of charcoal are exported while the local market only a small number marketed. Figure 4 shows the comparison in local market and exported market. The highest for export market was in 2009 (20, 747 tonnes) and in 2010 (20, 656 tonnes). However there are not significantly different in two years. While, the lowest for export market in 2000 (5600 tonnes). In the local market the highest number was in 2011 (6.602.33 tonnes) and the lowest number was in 2001 (883.35 tonnes) respectively.

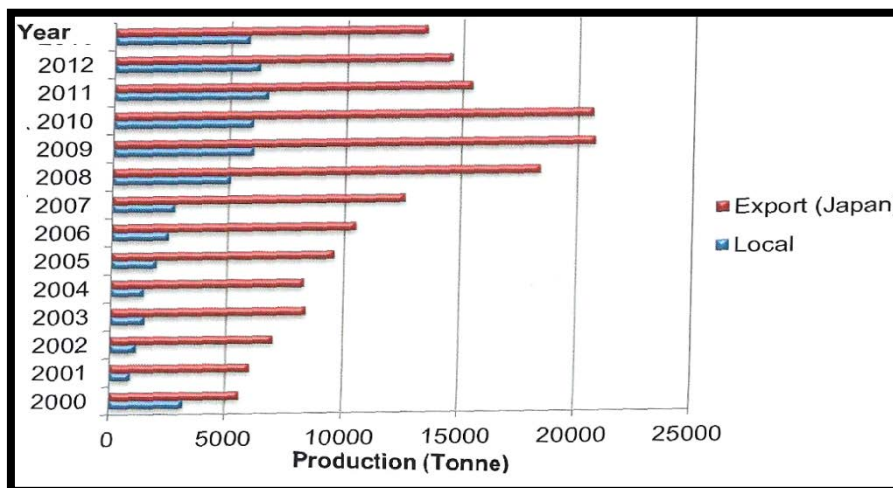

Figure 4: Market Distribution of Charcoal Production for Local and Export Market.

### 3.5 Market Distribution of Charcoal Production for Local

Charcoal production for local are marketed in three states, namely Kuala Lumpur, Penang, and Perak. These three states have different demand annually. The number of

marketed charcoal does not shows a significant increase (Figure 5). In Kuala Lumpur, the highest number was in 2009 (3,353.25 tonnes) and the lowest number was in 2001 (196.5 tonnes). While, in Penang, the highest number shown was in 2012 (2,131 tonnes) and the lowest number was in 2002 (372 tonnes). In Perak the highest number was in 2012 (2843 tonnes) and the lowest was in 2005 (36.92 tonnes). From the analysis, there were no significant different in each year for three states.

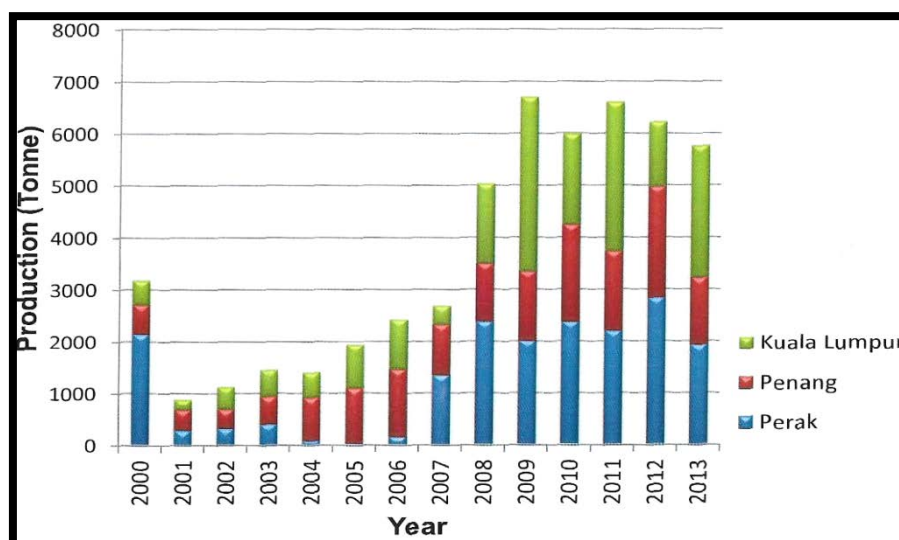

Figure 5: Distribution for Local Market in Kuala Lumpur, Penang and Perak.

#### 4. CONCLUSIONS

Based on the result of the study, trend of charcoal production for a period 13 years from 2000 to 2013 at the Kuala Sepetang were increased by each year and the production is influenced by the current demand in the market. In average the production of charcoal was increased about 1,437 tonnes each year. Market production for export market is higher in each year compared to the local market. Charcoal products in Kuala Sepetang are mainly exported to Japan. More than 70% products of charcoal are exported. However, market distribution of charcoal at Local (Perak, Penang, Kuala Lumpur) is relatively consistent in every year. Royalty collection based on the number kiln operation was increased by RM 50,668 each year.

#### REFERENCES

- Azahar, M & Nik Mohd Shah, N.M (2003). A working plan for the Matang Mangrove Forest Reserve Perak: Third 10- year period (2000-2009) of the Second Rotation (Fifth Revision). State Forestry Department, Perak, Malaysia. 320pp.
- Chan, H.T. (1989). A Note on the Three Species and Productivity of a Natural Dryland

- Mangrove Forest in Matang, Peninsular Malaysia. *Journal of Tropical Forest Science*, 1(4): 399 - 400.
- FAO (2007), *Mangrove Guidebook for Southeast Asia*, Food and Agriculture Organization, Bangkok, Thailand.
- FDP (2005). *Forestry Statistic Peninsular Malaysia*, Forestry Department Peninsular Malaysia, Kuala Lumpur.
- FDP (2010). *Forestry Statistic Peninsular Malaysia*, Forestry Department Peninsular Malaysia, Kuala Lumpur.
- Nik Mohd Shah, N. M., shah Rani, A. Z., and Zakaian, A. H. (2005). Management and Conservation of Mangrove: Selangor Experience. In M. I. Shahahrudin, M. Azahar, U. Razani, A. B. kKamaruzaman, K.L. Lim, R. Suhaili, Md. S. jalil and A. Latiff (Eds.), *Sustainable Management of Matang Mangrove : 100 years and Beyond* (pp. 91 -101). Kuala Lumpur, forest Peninsular Malaysia.
- Watson, J.G. (1928). *Mangrove Forests of the Malay Peninsular*. Malayan Forest Records No. 6, Federated Malay States, Kuala Lumpur. 275pp.



## P-17

### **Rigging methods of Simple Logging Cable Systems for Small-scale Forestry**

Haruka Aoki<sup>1,\*</sup>, Yasushi Suzuki<sup>2</sup>, Tetsuhiko Yoshimura<sup>3</sup>, Shin Yamasaki<sup>4</sup> and Toshihiko Yamasaki<sup>4</sup>

<sup>1</sup> Graduate School of Integrated Arts and Sciences, Kochi University, B200 Monobe, Nankoku, Kochi 783-8502, Japan.

<sup>2</sup> Faculty of Agriculture and Marine Science, Kochi University, B200 Monobe, Nankoku, Kochi 783-8502, Japan.

<sup>3</sup> Faculty of Life and Environmental Science, Shimane University, 1060 Nishikawatsu-cho, Matsue, Shimane 690-8504, Japan.

<sup>4</sup> Kochi Prefectural Forest Technology Center, 80 Ohira, Tosayamada, Kami, Kochi 782-0078, Japan.

\*Corresponding author: Tel: + 81-88-864-5137 E-mail: [b16m6f01@s.kochi-u.ac.jp](mailto:b16m6f01@s.kochi-u.ac.jp)

**Abstract:** A majority of forest owners is that of small-scaled ones in Japan. They prefer small-scale machines for forestry operations because of their low investment although with low productivity. One of such machines is a winch equipped mini forwarder with a loading capacity around 1 t. A kind of simple cable system can be rigged up using the machine. The system consists of the machine, a standing skyline of 10-12 mm of a maximum span of around 100 m, a carriage without clamping device, and a main line driven by the winch. There exist a few types of rigging methods of which are mainly different on a mechanism of blocks on the carriage for lifting and/or lateral pulling of a load. This paper at first classifies the rigging methods. Secondly, a force balance at the carriage is analyzed in order to assess and compare the availability of lateral pulling between the methods. The analysis is oriented to support a possible improvement of the system with low cost.

**Keywords:** Logging cable systems, Rigging methods, Small scale forestry

#### **1. INTRODUCTION**

In small-scale forestry, relatively inexpensive and compact machines such as forest work vehicles are often used. When the road network density is not so high, collecting operation is carried out by simple winching with a winch installed on the logging

machines. When long distance collecting operation is required, a short-span logging cable system can be used with simple rigging up methods. Such simple rigging methods are sometimes called as “light logging cable system”. Although cases have come to be seen in various places, the classification of rigging methods is not still clear. Examining each case, it seems that many carriers used for light cable systems do not have a clamping mechanism. However, considering work efficiency, it is desirable that the carriage should not move during pulling or lateral logging. In a cable system in which a moving pulley is used for a loading line of a carriage, in addition to increasing the loading force, such an effect is also important. In this research, we aim to present realistic and useful light logging cable systems by investigating and arranging the simple cable system in Japan and overseas, and also by actual measurement data and simulation. In the present study, we will classify and compare the rigging methods of simple cable systems. Then the mooring force of the carrier is examined by a static theoretical model, while the force changes depending on the direction of applied load in the rigging methods of simple cable system. In the examination, we evaluate the force corresponding to two types of rigging methods, that is, the double force and the triple force methods. In addition, for the purpose of comparison, the examination is also made on the system of the single force method, although it is not normally used for actual operations.

## 2. METHODS

To compare the forces of mooring the carriers, we selected three systems. That is, the one with triple boosting force (Tosa-no-mori method, ZENRINKYOU 2010; Fig. 3), the one with double boosting force (Miyoshi method, Souda 2008; Fig. 2), and the one with single boosting force (Fig. 1). First, let us consider a case where a load  $P$  is applied at an arbitrary point  $C$  as shown in Figure 4 using the definition of the inclined load of the moat (Hori 1974). Figure 4 focuses on the carrier, which is shown in Figures 5 and 6 (the origin is equivalent to  $C$  in Figure 4), and the meanings of the symbols are shown in Table 1.

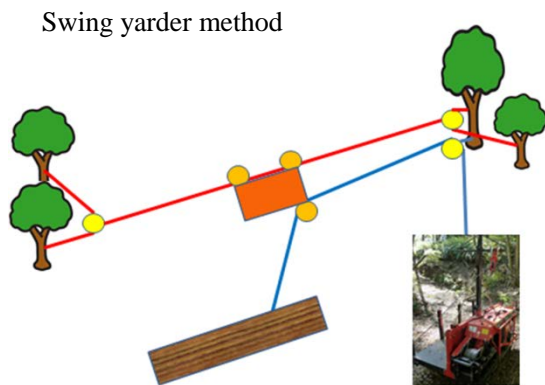

Figure 1. Schematic diagram of Swing yarder method

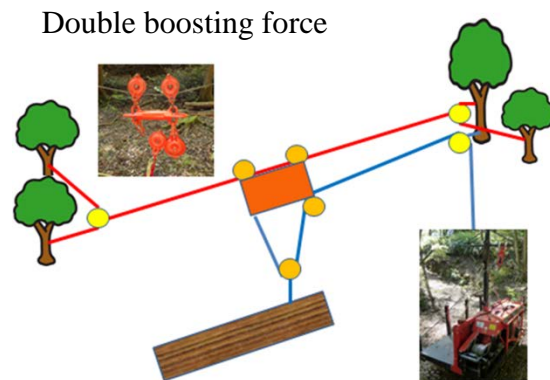

Figure 2. Schematic diagram of double boosting force method (Miyoshi)

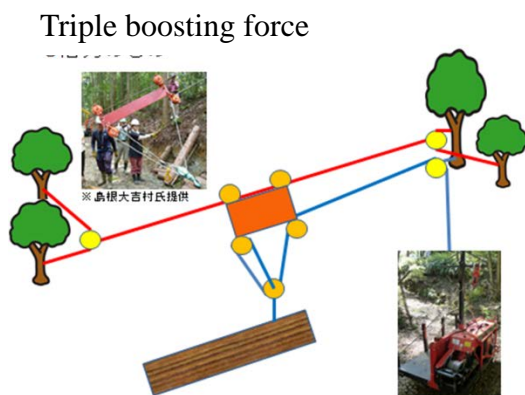

Figure 3. Schematic diagram of triple boosting force method (Tosa-no-mori)

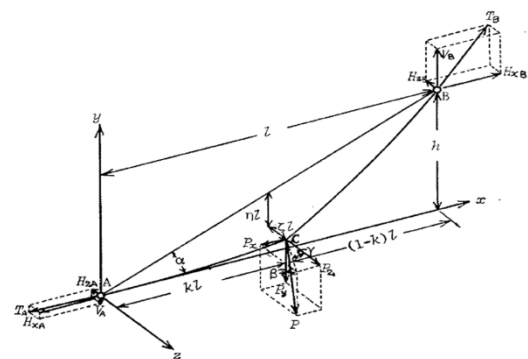

Figure 4. Schematic diagram of the inclined weight application (Hori, 1974)

Table 1. Definition of symbols

- $F$ : Direct attractive force of the main line (N)
- $W$ : Self-weight of carriage and pulley (N)
- $P$ : Weight of lateral yarding (N)
- $P_x, P_y, P_z$ : Component for  $x, y, z$  direction (N)
- $R$ : Force to move the carriage in the direction of the cable (N)
- $\alpha$ : Elevation angle of cable ( $^\circ$ )
- $\beta$ : Angle of  $P$  from  $y$  axis ( $^\circ$ )
- $\gamma$ : Angle of  $P$  with respect to the  $yz$  plane ( $^\circ$ )

Table 2. List of formulae

- $R_x = F - P_x$  (1)
- $P_x = P \cdot \sin\beta \cdot \sin\gamma$  (2)
- $P_y = P \cdot \cos\beta$  (3)
- $P_z = P \cdot \sin\beta \cdot \cos\gamma$  (4)
- $R = F - (W \cdot \sin\alpha + P_y \cdot \sin\alpha + P_x \cdot \cos\alpha)$  (5)
- $F = P$  (6a)
- $F = P/2$  (6b)
- $F = P/3$  (6c)

Assuming that the aerial cable is straight and not deflected, when  $\alpha$  (elevation angle of cable) = 0, using the formula in Table 2, a combination of  $\beta$  and  $\gamma$  ( $0^\circ$  to  $90^\circ$  with an interval of  $10^\circ$ , that is, 100 combinations, for the  $1 \times$ ,  $2 \times$  and  $3 \times$  force models), the resultant force  $R$  to move the carriage along the aerial rope was obtained (Fig. 7). Also, in case of  $\alpha \neq 0$ , while  $\alpha$  changes at  $5^\circ$  intervals between  $5^\circ$  and  $30^\circ$ , we counted the number of  $R$  which takes a negative value among 100 combinations of  $\beta$  and  $\gamma$ . The negative  $R$  means that the resultant force on the carriage acts toward the opposite direction of which the carriage is pulled downward; that is, the carriage stabilizes during lateral pulling. The number of combinations is illustrated in Fig. 8. In the calculation, it is assumed that the own weight of the carriage  $W$  is 25 kgf (0.25 kN), and  $P$  varies in 50 kgf (0.49 kN) increments between 50 kgf (0.49 kN) and 300 kgf (2.94 kN).

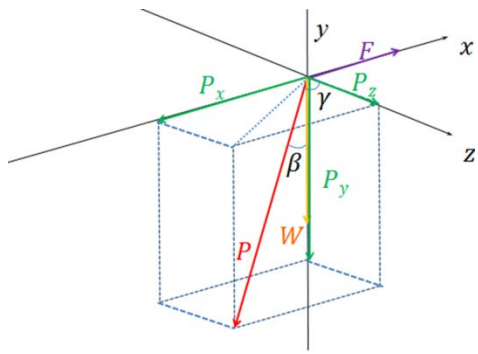

Figure 5. The force applied on the carriage when  $\alpha = 0$

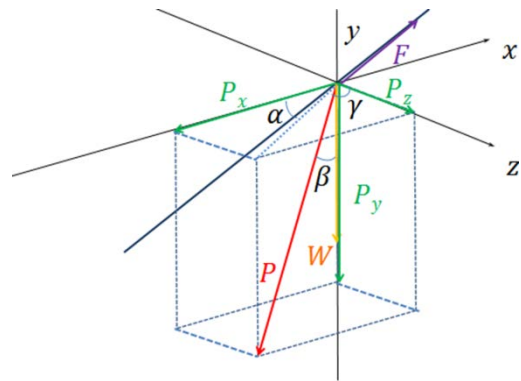

Figure 6. The force applied on the carriage when  $\alpha \neq 0$

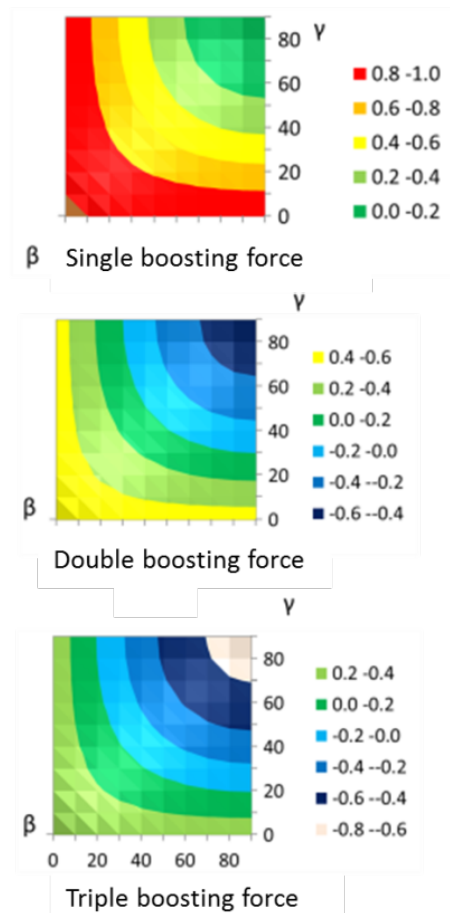
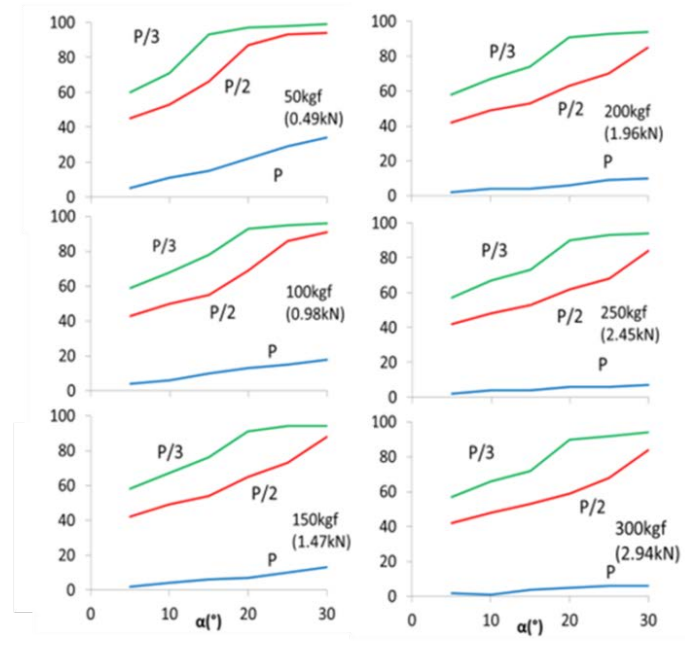

Figure 7. Stability of the carriage in case of  $\alpha = 0$



P: Single boosting force method  
P/2: Double boosting force method  
P/3: Triple boosting force method

Figure 8. Number of combinations when the carriage is stable in case of  $\alpha \neq 0$

### 3. RESULTS AND DISCUSSION

In Fig. 7, the combination of angles in which  $R$  takes a negative value (the carrier is stabilized) is indicated by the bluish colour. Compared to the one with the  $1 \times$  power (single boosting power method), in which there is no folding back of the main line between the carriage and the luggage hook, the movable pulley is added in the Miyoshi and the Tosa-no-mori methods (the double and triple force methods). In the two methods, there is single or double folding of between the carriage and the luggage hook with a movable pulley. It can be confirmed that the effect of mooring the carriers is increased in these two methods.

Furthermore, in Fig. 8, the number of combinations in which  $R$  takes a negative value is significantly reduced as the load  $P$  increases for the single boosting power method. This tendency is getting gentler in the case of the double or triple boosting power method. Therefore, it was confirmed that, even when  $\alpha = 0$  or  $\alpha \neq 0$ , compared to

the one with a single force in which the wire rope does not fold back between the carrier and the luggage hook, the method with a fold is more likely to make the carriage more stable. It could be confirmed. That is, the stabilizing effect of the carriage is greater in the Miyoshi method and Tosa-no-mori method, which added moving pulleys and made folding back.

### **ACKNOWLEDGEMENTS**

This research was funded by JSPS KAKENHI Grant Numbers 15H04508 and 16K07779, as well as supported by “Biomass TOSA” project of Kochi University.

### **REFERENCES**

- Hori, T. (1974) “Estimation of the Cable Tension and the Load Deflection of the Skylinecable with an Inclined Load.” *J. Jpn. For. Soc.*, 56, 216-222 (in Japanese).
- Souda, K. (2008) *Technical Information Card No.111 How to use swing yarders - Importance of skyline height in logging operation -*. \* Forest Research Center, Tokushima Agriculture, Forestry, and Fisheries Technology Support Center, 2pp.
- ZENRINKYOU (National Forestry Improvement Promotion Association) (2010) “Utilization of mini-forwarders.”\* (*Basics of forestry: Recommendation of self-logging\**, ZENRINKYOU Ed.) 78-80.

\* Tentative translations by the authors.

## P-18

### Availability of Small-Scale Woody Biomass Power Generation from the View of Forest Resources in Tochigi Prefecture, Japan

Takahisa Yamamoto<sup>1,\*</sup> Kazuhiro Aruga<sup>1</sup> and Hiroaki Shirasawa<sup>2</sup>

<sup>1</sup> Department of Forest Science, Faculty of Agriculture, Utsunomiya University, 350 Mine, Utsunomiya, Tochigi 321-8505, Japan.

<sup>2</sup> Education and Research Center of Alpine Field Science, Faculty of Agriculture, Shinshu University, 8304 Minami-Minowa, Kamiina, Nagano 399-4598, Japan.

\*Corresponding author: Tel: +81-28-649-5544

E-mail: [ma178506@cc.utsunomiya-u.ac.jp](mailto:ma178506@cc.utsunomiya-u.ac.jp)

**Abstract:** This study extracted production forests and estimated the annual availability of forest biomass resources under profitable forest management in Tochigi prefecture, Japan. Production forests were extracted as sub-compartments where expected revenues surpassed all costs—from planting to final harvesting—for a 55-year rotation. Then, annual availability of forest biomass resources were estimated on the basis of annual supply potentials from production forests. Annual supply potentials of timber and forest biomass resources were 1,149,768 m<sup>3</sup> and 450,455 tons, respectively. Annual availability were estimated at 456,441 m<sup>3</sup> and 179,215 tons, respectively. In order to maintain a sustainability of forest management, production forests were extracted with more than 1,880,000 JPY/ha of profits for a 55-year rotation. As a result, annual availability were estimated at 102,835 m<sup>3</sup> and 40,110 tons, respectively. Since the 2,400-kW Nakagawa woody biomass power generation plant consumed 35,000 tons/year of forest biomass resources, annual availability could meet its demand.

**Keywords:** Supply potential, Availability, Timber, Forest biomass resources, Profit

#### 1. INTRODUCTION

In July 2011, the “Feed-in Tariff (FIT) Scheme for Renewable Energy Use” was introduced in accordance with new legislation entitled the “Act on Purchase of Renewable Energy Sourced Electricity by Electric Utilities.” Under the FIT program, electricity generated from woody biomass is to be procured for 20 years at a fixed price (without tax) for unused materials such as thinned wood, small-sized log and logging

residue: 32 JPY/kW, general materials such as sawmill residue: 24 JPY/kWh, and recycled materials such as construction waste wood: 13 JPY/kWh (Agency for Natural Resources and Energy 2012). Power generated from unused materials is offered incentives, which is expected to promote the use of thinned wood, small-sized log and logging residue in the near future.

In Tochigi prefecture, the 2,400-kW Nakagawa woody biomass power generation plant was established in October, 2014. Its consumed 50,000 tons/year, of which 70% was expected from unused materials such as thinned wood and small-sized log. In order to examine a steady supply of unused materials (forest biomass resources), this study projected the supply potential and availability of unused materials from production forests which were extracted as sub-compartments where expected revenues surpassed all costs—from planting to final harvesting—for a 55-year rotation in Tochigi Prefecture, Japan.

## **2. MATERIALS AND METHODS**

The area of the Tochigi prefecture is 640,785 ha, of which approximately 54.5% is covered by forests. Approximately half of these forests are manmade (44.9%) with a volume of 42,255,000 m<sup>3</sup> (62.4%). The study site is a manmade forest of Japanese cedar (Sugi) and cypress (Hinoki) which are major plantation species in Japan (Figure 1). The number and area of the subcompartments were 289,717 and 132,054 ha, respectively.

In this study, we used forest registration data (tree species, site index, etc.) and GIS data (information on roads and subcompartment layers) for private and local government forests from the Tochigi Prefectural Government and for national forests from the Japan Forestry Agency as well as 10-m-grid digital elevation models (DEMs) from the Geographical Survey Institute. The data obtained from the Tochigi Prefectural Government and the Japan Forestry Agency were converted into the 10-m-grid raster data for consistency with the DEM data.

The number and area of the subcompartments based on combined forest registration and GIS data were 233,942 and 113,152 ha, respectively. These number and area were less than the actual number and area mentioned above because of the relational problem between forest registration data and GIS data. Species consists of Japanese cedar, 74,480 ha and Japanese cypress, 38,672 ha.

Production forests were extracted and annual availability of forest biomass resources were estimated in the following order: 1) estimation of supply potentials of timber and forest biomass resources based on the cutting, timber, and forest biomass rates in thinning and final felling operations during a 55-year rotation (Table 1); 2) estimation of total expenses from planting to final felling operations during a 55-year



rotation; 3) estimation of revenues from thinning and final felling operations during a 55-year rotation; 4) estimation of economic balances during a 55-year rotation; 5) extraction of profitable sub-compartments as production forests; and 6) estimation of annual availability of forest biomass resources on the basis of annual supply potentials from profitable sub-compartments. Full technical details will be found in the earlier papers (Aruga et al. 2014, Yamaguchi et al. 2014, Aruga et al. 2016).

Forest resources in each stand were predicted using the system yield table, Local Yield Table Construction System (LYCS3.3, Shiraishi 1985). Forest operation systems and machine sizes were determined on the basis of interviews with forestry cooperative officials. After the forest operation system and machine size were selected, costs such as the direct and indirect operation expenses associated with each machine, strip road establishment expenses and regeneration expenses were estimated. Three log markets and ten stockyards in the Tochigi prefecture were assumed to be the destination for timber and forest biomass resources (Figure 2). In order to reduce transportation distances and supply costs (Figure 3), nine satellite yards were established in addition to the power generation plant (1 in Figure 2).

Revenues were estimated using supply potentials and log prices: 10,000 JPY/m<sup>3</sup> for Japanese cedar, 20,000 JPY/m<sup>3</sup> for Japanese cypress, and 5,000 JPY/ton for forest biomass resources. For regeneration and thinning operations, subsidies were received in Japan. Subsidies were estimated using standard unit costs, areas, assessment coefficients, and the subsidy rate of the Tochigi Prefectural Government (2016). Sub-compartments with subsidized regeneration and thinning operations also received subsidies for the establishment of strip roads.

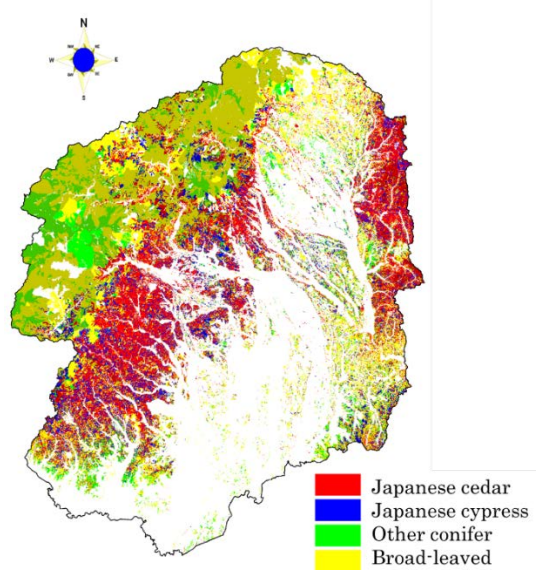

Figure 1. Species

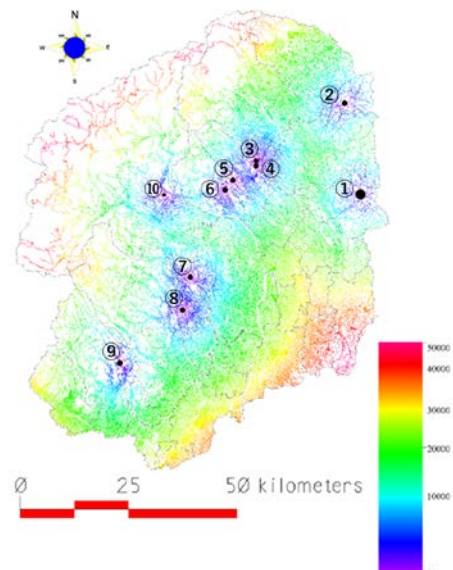

Figure 2. Transportation distances (m)

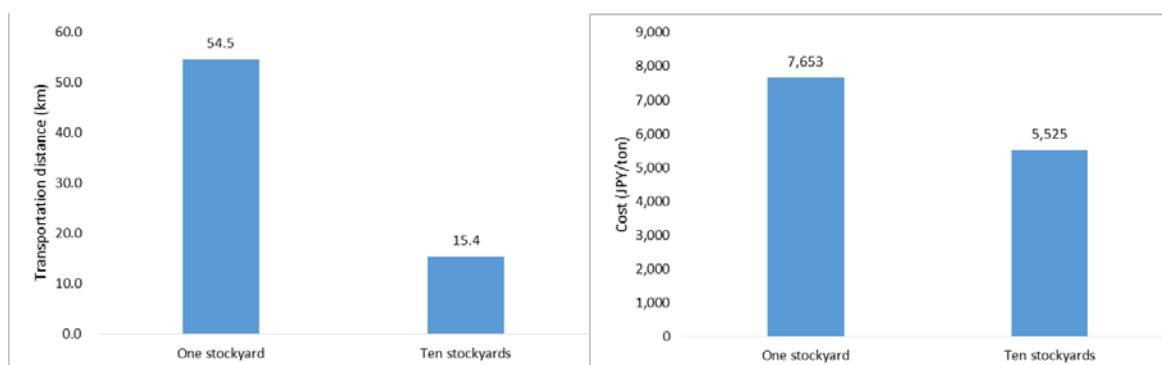

Figure 3. Transportation distances (Left) and supply cost (Right)

Table 1. Cutting, timber, and forest biomass rates (%)

	First Thinning	Second Thinning	Third Thinning	Final Felling
Age	25	35	45	55
Cutting	25	30	35	100
Timber	10	50	50	75
Forest Biomass	90	50	50	25

### 3. RESULTS

Annual supply potentials of timber and forest biomass resources were 1,149,768 m<sup>3</sup> and 450,455 tons, respectively (Figure 4). Annual availability were estimated at 456,441 m<sup>3</sup> and 179,215 tons, respectively. In order to maintain a sustainability of forest management, production forests were extracted with more than 1,880,000 JPY/ha of profits for a 55-year rotation. As a result, annual availability with sufficient profits were estimated at 102,835 m<sup>3</sup> and 40,110 tons, respectively. Since the 2,400-kW Nakagawa woody biomass power generation plant consumed 35,000 tons/year of forest biomass resources, annual availability with sufficient profits could meet its demand. Actual production volume of timber in 2015 were similar to annual availability whereas actual production volume of forest biomass resources in 2015 were similar to annual availability with sufficient profits. Therefore, timber production could be conducted with small amount of profits including subsidies to promote thinning operations whereas production of forest biomass resources could be conducted with sufficient profits on the stand easy for operation.

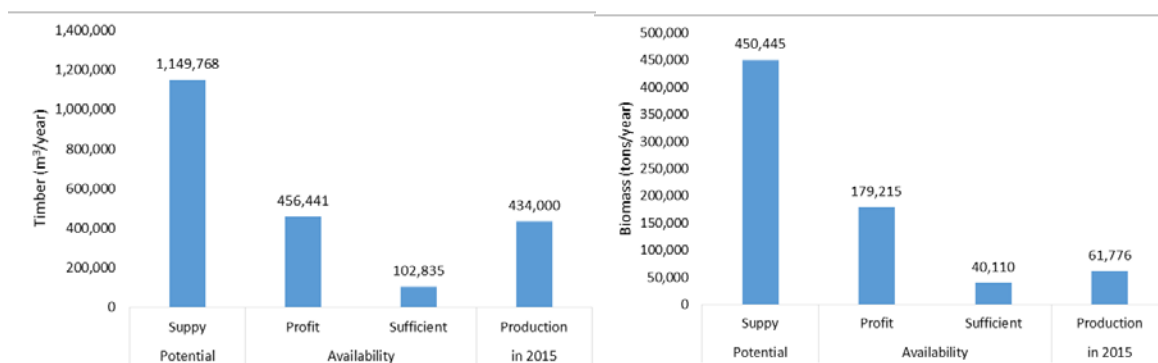

Figure 4. Supply potential and availability of timer (Left) and forest biomass resources (Right)

Forest biomass resources are assumed to be transported to the stockyards with the lowest costs until meeting the demand of the power generation plant. About 2,000 tons/year of surplus forest biomass resources would be available in Sano and Kanuma city. In Japan, German small-scale gasification systems such as Spanner consuming 330 tons/year of wood chips for 45 kWe and 120 kWth, and Burkhardt consuming 900 tons/year of wood pellets for 165 kWe and 260 kWth were introduced recently. These systems could be operated with surplus forest biomass resource in Sano and Kanuma city.

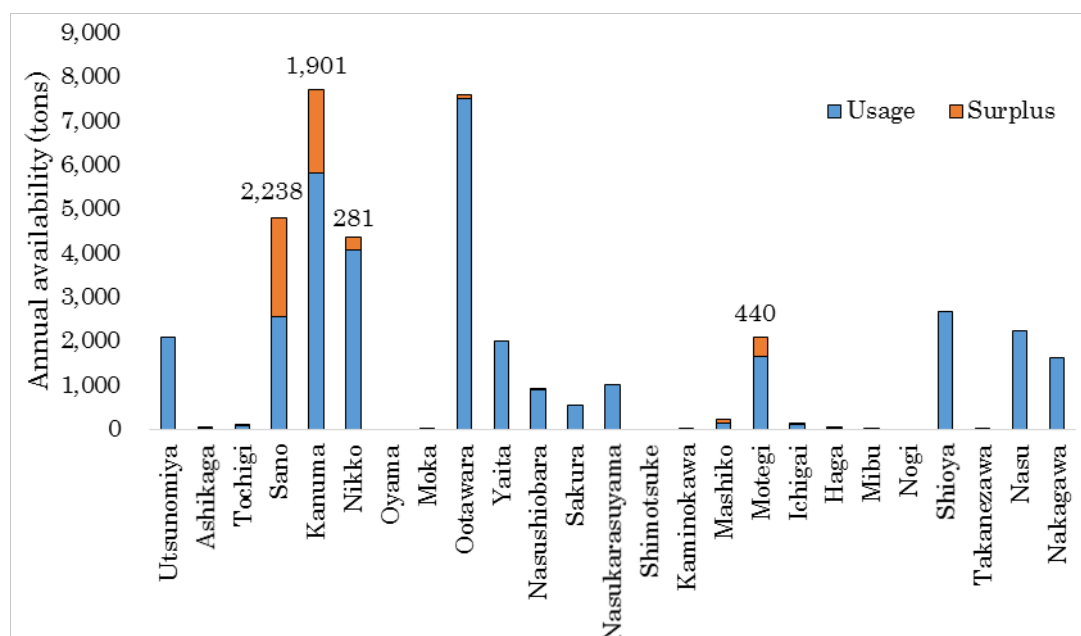

Figure 5. Availability of forest biomass resources for each city

## ACKNOWLEDGEMENTS

We are grateful to the Tochigi Prefectural Government and the Japan Forest Agency for

providing the required data. Parts of this study were supported by Yashima study grant and JSPS KAKENHI grant number 15H04508.

## REFERENCES

- Agency for Natural Resources and Energy (2012) *Feed-in Tariff scheme in Japan*, <[http://www.meti.go.jp/english/policy/energy\\_environment/renewable/pdf/summary\\_201207.pdf](http://www.meti.go.jp/english/policy/energy_environment/renewable/pdf/summary_201207.pdf)> (Accessed 22 April 2017).
- Aruga, K. (2016) “Analyses on strip road networks and profitability of final felling operations considering regeneration expenses at Nasu in Tochigi prefecture, Japan.” *Eur. J. For. Eng.*, 2, 74-81.
- Aruga, K., Murakami, A., Nakahata, C., Yamaguchi, R., Saito, M. and Yoshioka, T. (2014) “Estimating annual available amounts of forest biomass resources with total revenues and costs during the 60-year rotation in a mountainous region in Japan.” *Cro. J. For. Eng.*, 35, 125-138.
- Shiraishi, N. (1985) “Study on the growth prediction of even-aged stands.” *Bull. Tokyo Univ. For.*, 75, 199-256 (in Japanese with English summary).
- Tochigi Prefectural Government (2016) *Forestation program standard unit cost table of Fiscal year 2016*, Tochigi Prefectural Government (in Japanese).
- Yamaguchi, R., Aruga, K. and Nagasaki, M. (2014) “Estimating the annual supply potential and availability of timber and logging residue using the forest management records of the Tochigi prefecture, Japan.” *J. For. Res.*, 19, 22-33.

## P-19

### **An Optimum Size of Slash Pile for a Grinding Operation -Modeling the Operations of a Grapple Excavator and a Horizontal Grinder-**

Takuyuki Yoshioka<sup>1,\*</sup>, Shohei Kameyama<sup>2</sup>, Koki Inoue<sup>1</sup> and Bruce Hartsough<sup>3</sup>

<sup>1</sup>Coll. of Bioresour. Sci., Nihon Univ., 1866 Kameino, Fujisawa 252-0880, Japan

<sup>2</sup>Grad. Sch. of Bioresour. Sci., Nihon Univ., 1866 Kameino, Fujisawa 252-0880, Japan

<sup>3</sup>Dept. of Biol. and Agric. Eng., Univ. of California, Davis, One Shields Ave., Davis, CA  
95616, USA

\*Corresponding author: Tel.: +81-466-84-3608

E-mail: [yoshioka.takuyuki@nihon-u.ac.jp](mailto:yoshioka.takuyuki@nihon-u.ac.jp)

**Abstract:** Processing the woody biomass waste piles for use as fuel instead of burning them was investigated. At each landing slash pile location, a 132 kW grapple excavator was used to transfer the piles into a 522 kW horizontal grinder. Economies of scale could be expected when grinding a larger pile, while the efficiency of a loading operation might be diminished. Therefore, three piles, *i.e.*, ‘Small (Length: 20 m; Width: 15 m; Height: 4 m),’ ‘Medium (L: 30 m; W: 24 m; H: 4 m),’ and ‘Large (L: 35 m; W: 30 m; H: 4 m)’ piles, were ground and the operations were time-studied. As a result, grinding the ‘Medium’ pile was found to be the most productive, 30.65 BDT/PMH<sub>0</sub>, thereby suggesting that there might be an optimum size of slash pile for a grinding operation. This study discussed that by modeling the excavator and grinder operations. Based on the modeling, the productivity of grinding at the landing area of 710 m<sup>2</sup> of slash pile location was estimated to be 31.24 BDT/PMH<sub>0</sub>, which was the most productive.

**Keywords:** Fuel reduction, Grinding operation, Modeling, Slash pile, Woody biomass

#### **1. INTRODUCTION**

In the previous study, the Placer County Air Pollution Control District (PCAPCD), California, USA demonstrated significant air emissions reduction through the diversion of forest biomass that was scheduled for open pile burning (Springsteen *et al.*, 2011). In this project, as a next step, the PCAPCD sponsored a research that tracked the economic costs and air emissions generated from the collection, processing, and transport of forest

harvest residuals generated at the Blodgett Forest Research Station (BFRS), the Center for Forestry, the University of California, Berkley in 2012, with the objective of quantifying the emissions reductions gained from utilizing the biomass for energy production compared to open pile burning (Springsteen *et al.*, 2015; Figure 1).

In order to monitor equipment operating costs and efficiencies as well as equipment air emissions, the authors of this paper investigated processing the woody biomass waste piles. At each landing slash pile location, a grapple excavator was used to transfer the piles into a horizontal grinder (Figure 2).

Economies of scale can be expected when grinding a larger pile, while the efficiency of a loading operation may be diminished. Relationship between the slash pile size and the productivity of a grinder, however, has been discussed little so that three piles, *i.e.*, 'Small,' 'Medium,' and 'Large' piles, were ground and the operations were time-studied (Yoshioka and Hartsough, 2015).



Figure 1. Open pile burning



Figure 2. Grinding operation

## 2. MATERIALS AND METHODS

The BFRS, 1,198 ha of Sierra Nevada forest land locates east of Georgetown, California. Woody biomass waste piles at the BFRS included tree tops, limbs, and small trees. The piles were generated from thinning treatments in mixed conifer plantations during the summer of 2012. The treatment objectives were to reduce fire hazard, increase average tree vigor, and increase species diversity. Operations were typical of those in the Sierra Nevada, where young and dense forests have developed following wildfires or even-aged harvests. Plantations were thinned to an average of 272 trees per ha from pre-treatment stocking levels of 549 trees per ha. Four plantations were thinned, covering a total of approximately 32 ha. Because smaller trees were preferred for removal, average stem diameter (for residual trees) at breast height (DBH) increased from 30.2 to 33.3 cm. Sawlogs greater than 15.2 cm diameter on the small end and at

least 3.05 m long were transported to a sawmill for processing into lumber products. Unmerchantable trees (too small to process into sawlogs) plus the tops and limbs of merchantable trees were piled at landings adjacent to roadside for disposal by open burning. The overall size of the piles generated were typical of thinning operations in young and mature forests, with bulk volume averaging 1,784 m<sup>3</sup> per pile.

At each BFRS slash pile, a 132 kW grapple excavator (Model: 290 LX; Vendor: Link-Belt) was used to transfer the waste material into a 522 kW horizontal grinder (Model: Beast 3680; Vendor: Bandit). Wood chips from the grinder were conveyed directly into chip vans. Equipment and engines used for the loading and chipping operations were sized for scale of operations that a medium or large landowner might consider. Landing piles for the project contained at least 100 green tons of biomass wastes. Operations of the excavator and grinder were carefully observed and tracked including total operating hours, productive operating hours, diesel fuel use, and biomass production.

For analyzing the relationship between the slash pile size and the productivity of a grinder, three piles, *i.e.*, ‘Small (Length: 20 m; Width: 15 m; Height: 4 m; 51.41 bone dry tons (BDT)),’ ‘Medium (L: 30 m; W: 24 m; H: 4 m; 122.66 BDT),’ and ‘Large (L: 35 m; W: 30 m; H: 4 m; 173.78 BDT)’ piles, were picked out from total 6 piles for process and transport, and grinding operations were time-studied. The element operations of the excavator monitored were as follows: loading (grabbing and pivoting); unloading (releasing and pivoting); shaking waste material off; waiting for the grinder’s swallowing of material; pushing material into the grinder; reorienting or repositioning material from the pile; loading with moving; unloading with moving.

### **3. RESULTS AND DISCUSSION**

#### **3.1 Relationship between the slash pile size and the productivity of a grinder**

Results of the time study are shown in Table 1. The times of loading and shaking will be shortened by improving the piling method such as orienting the tops and limbs so that they can most readily be fed into the grinder. Modifying the infeed conveyor of the grinder, *e.g.*, extending its length, will improve the times of waiting and pushing. With respect to the impact of slash pile size, the average times of loading and unloading were not influenced by the pile size. On the other hand, the frequency and the average time of reorienting or repositioning were increased and lengthened, respectively, as the size of pile bulked up. Percentages of the time of reorienting or repositioning to the total observed were also proportional to the pile size.

Results of the time study per BDT (Figure 3) show that grinding the ‘Medium’ pile was the most productive, 30.65 BDT/PMH<sub>0</sub> (= 122.66 BDT / 14,408 sec x 3,600 sec/hr),

thereby suggesting that there might be an optimum size of slash pile for a grinding operation. The Nordic guidelines stating the preferable size is 20-30 meters length of at maximum 4 meters height may assist this result (Nilsson, 2009). The weights of slashes per loading were calculated to be 0.138 BDT/time (= 51.41 BDT / 359 + 13 times), 0.212 BDT/time (= 122.66 BDT / 550 + 29 times), and 0.208 BDT/time (= 173.78 BDT / 802 + 33 times) when grinding ‘Small,’ ‘Medium,’ and ‘Large’ piles, respectively, which suggests that reorienting or repositioning material from the pile could make the amount of slashes per loading increase and the productivity of the grinder raise. However, reorienting or repositioning from too large pile may take too much time, resulting in the decline in the overall operational efficiency.

Table 1. Results of the time study

Element operation		Pile		
		Small	Medium	Large
Loading	Time (sec)	3484	5312	7614
	<i>n</i>	359	550	802
	Avg. (sec)	9.70	9.66	9.49
	Std. Dev. (sec)	5.55	4.29	4.56
Unloading	Time (sec)	3114	4776	6848
	<i>n</i>	383	594	863
	Avg. (sec)	8.13	8.04	7.94
	Std. Dev. (sec)	3.09	3.00	2.73
Shaking	Time (sec)	92	95	201
	<i>n</i>	14	15	29
	Avg. (sec)	6.57	6.33	6.93
	Std. Dev. (sec)	3.08	2.50	2.84
Waiting	Time (sec)	479	1314	1875
	<i>n</i>	29	71	88
	Avg. (sec)	16.52	18.51	21.31
	Std. Dev. (sec)	18.06	19.95	19.32
Pushing	Time (sec)	1013	1190	1316
	<i>n</i>	132	168	180
	Avg. (sec)	7.67	7.08	7.31
	Std. Dev. (sec)	5.02	4.83	7.06
Reorienting or repositioning	Time (sec)	52	1056	6826
	<i>n</i>	3	11	21
	Avg. (sec)	17.33	96.00	325.05
	Std. Dev. (sec)	2.31	126.17	732.85
Loading with moving	Time (sec)	100	201	284
	<i>n</i>	13	29	33
	Avg. (sec)	7.69	6.93	8.61
	Std. Dev. (sec)	3.82	2.25	3.19
Unloading with moving	Time (sec)	185	464	581
	<i>n</i>	18	47	56
	Avg. (sec)	10.28	9.87	10.38
	Std. Dev. (sec)	6.95	5.44	9.28
Total		8519	14408	25545



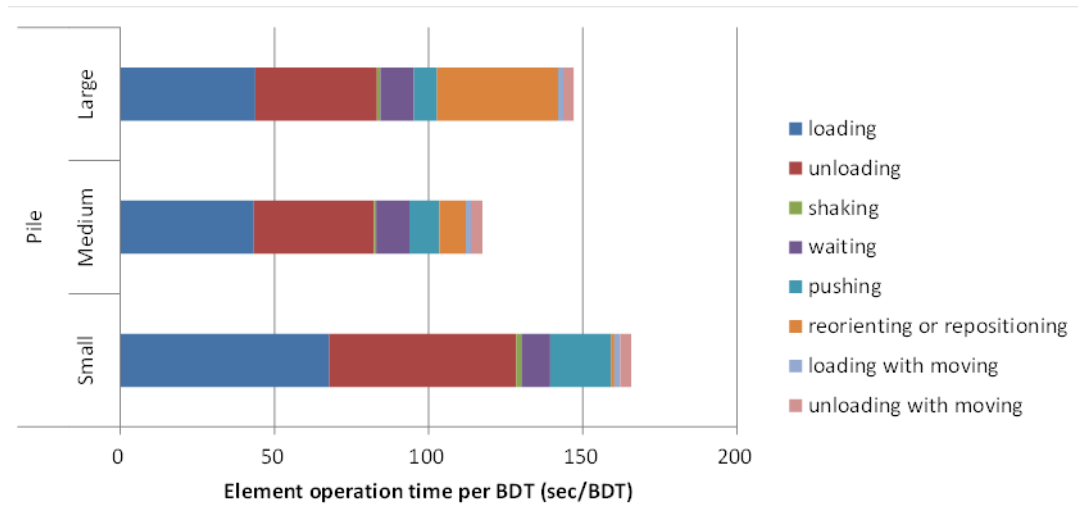

Figure 3. Element operation time per BDT

### 3.2 Modeling of the excavator and grinder operations

An optimum size of slash pile for a grinding operation was discussed by modeling the excavator and grinder operations.

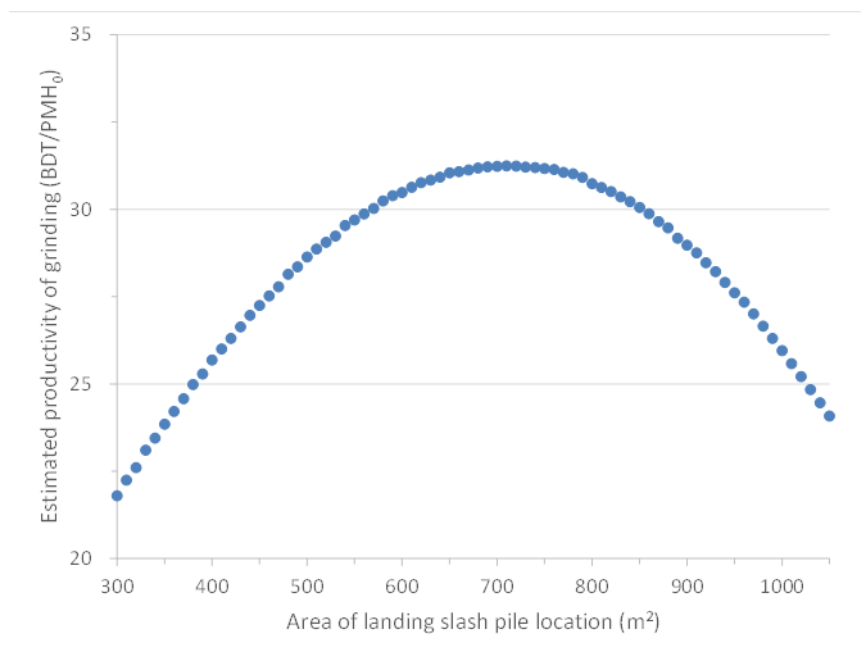

Figure 4. Relationship between the area of landing slash pile location and the estimated productivity of grinding

Productivities were estimated, from the model, to be 21.78 BDT/PMH<sub>0</sub>, 31.17 BDT/PMH<sub>0</sub>, and 24.27 BDT/PMH<sub>0</sub> when grinding at the landing areas of 300 m<sup>2</sup> (15 m x 20 m for ‘Small’ pile), 720 m<sup>2</sup> (24 m x 30 m for ‘Medium’ pile), and 1,050 m<sup>2</sup> (30 m x 35 m for ‘Large’ pile), respectively, while the monitored productivities were 21.73 BDT/PMH<sub>0</sub> for ‘Small’ pile, 30.65 BDT/PMH<sub>0</sub> for ‘Medium’ pile, and 24.49 BDT/PMH<sub>0</sub> for ‘Large’ pile so that the constructed model was considered to well replicate the actual operations. Based on the model, the relationship between the area of landing slash pile location and the estimated productivity of grinding is shown in Figure 4. From Figure 4, the productivity of grinding at the landing area of 710 m<sup>2</sup> of slash pile location was estimated to be 31.24 BDT/PMH<sub>0</sub>, which was the most productive.

#### **ACKNOWLEDGEMENT**

This study was financially supported in part by JSPS KAKENHI Grant Numbers JP24580213 and JP15H04508.

#### **REFERENCES**

- Nilsson, B. (2009) *Costs, CO<sub>2</sub>-emissions and energy balance for applying Nordic methods of forest biomass utilization in British Columbia*, M.Sc. thesis, Dept. of For. Resour. Manage., Swedish Univ. of Agric. Sci., Umeå, Sweden. 43 p.
- Springsteen, B., Christofk, T., Eubanks, S., Mason, T., Clavin, C., and Storey, B. (2011) “Emission reductions from woody biomass waste for energy as an alternative to open burning.” *J. Air Waste Manage. Assoc.*, 61(1), 63-68.
- Springsteen, B., Christofk, T., York, R., Mason, T., Baker, S., Lincoln, E., Hartsough, B., and Yoshioka, T. (2015) “Forest biomass diversion in the Sierra Nevada: Energy, economics and emissions.” *Calif. Agric.*, 69(3), 142-149.
- Yoshioka, T. and Hartsough, B. (2015) “A survey of grinding operations in the Sierra Nevada, California: Relationship between the slash pile size and the productivity of a grinder.” *38th Annual Meeting of the Council on Forest Engineering: Engineering Solutions for Non-industrial Private Forest Operations*. 68-78.

**P-20**

**Effect of Variation of Canopy Openness after Thinning Understory  
Vegetation**

Yasutaka Watanabe<sup>1,\*</sup>, Yukari Ochi<sup>2</sup> and Yasushi Suzuki<sup>3</sup>

<sup>1</sup> Forestry Research Center, Hiroshima Prefectural Technology Research Center, 4-6-1 Tokaichi-higashi, Miyoshi, Hiroshima 728-0013, Japan.

<sup>2</sup> Urban Development Department, Matsuyama City Hall, 4-7-2 Matsuyama, Ehime 790-8571, Japan.

<sup>3</sup> Faculty of Agriculture and Marine Science, Kochi University, 200 Monobe-Otsu, Nankoku, Kochi 783-8502, Japan.

\*Corresponding author: Tel: + 81-824-63-5181

E-mail: [y-watanabe73265@pref.hiroshima.lg.jp](mailto:y-watanabe73265@pref.hiroshima.lg.jp)

**Abstract:** We evaluated the effect of canopy openness on understory vegetation by taking hemispherical photographs and making crown projection maps of test sites after qualitative thinning or line thinning. The test sites were mixed forests of sugi (*Cryptomeria japonica*) and hinoki (*Chamaecyparis obtusa*) in Kami City, Kochi Prefecture. Two cutting treatments (qualitative thinning and line thinning) and three stages after thinning (immediately, 5 years, and 10 years after thinning) were set as the factors. There was no significant correlation between canopy openness in the hemispherical photographs and in the crown projection maps. On the other hand, there was a significant negative correlation between canopy openness in the crown projection maps and in the understory vegetation cover. We are planning to continue further investigation of the sites and evaluate the effect of thinning treatments.

**Keywords:** Canopy openness, Understory vegetation, Hemispherical photograph, Crown projection map, thinning

## **1. INTRODUCTION**

Although currently 51% of the total area of Japanese cultivated forests is over 50 years old, and thinning is required for many forests, most of the forests are still not being thinned. The main purpose of thinning is to ensure individual trees mature sufficiently and for the forests to provide public benefits. The general public expects that forests should “function to prevent disasters such as landslides and floods”, and public benefit

functions are particularly important for forests (Forestry Agency 2015). However, in many of the untreated stands, there is less understory vegetation, the risk of topsoil overflow caused by rainfall is high, and public functions such as water soil conservation cannot be fully provided. There are cases where the vegetation does not sufficiently recover even after thinning because the forests do not have enough canopy openness after thinning, and public function normally enhanced by understory vegetation is not recovered (Watanabe et al. 2014, 2017). Those stands need to be properly managed in the future and the effect of such proper management needs to be evaluated.

Thinning rate in volume and in number are conventional criteria for assessing the thinning effect. However, both criteria are aimed at material growth, and assessing the recovery of lower vegetation is not considered. As a means of evaluating the influence of thinning on understory vegetation, researchers have used relative illuminance, which can directly measure the influence on understory vegetation. However, when measured with an illuminometer, values may differ depending on the measurement date and time, and it is difficult to precisely evaluate the difference between the measurement points.

When hemispherical photographs are used, relative illuminance inside forests can be simply evaluated. Sano (1997) reported a correlation between relative solar radiation estimated using hemispherical photographs and the growth of lower story trees. However, the relationship between illuminance in the forest after thinning and recovery of understory vegetation is still not clear.

Therefore, in this study, to evaluate the influence of thinning on understory vegetation recovery, we evaluated the effect of thinning using two cutting treatments (qualitative thinning and line thinning): measurements were taken immediately after thinning and at five and ten years after thinning, using canopy openness and relative scattered light in the forests as indicators. In addition, although there are many methods of calculating canopy openness (CO: %), we selected two, measurements using crown projection maps and measurements using hemispherical photographs, and examined which method is the best.

## **2. METHODS**

### **2.1 Study site**

The survey was conducted by selecting 12 plots (10 × 10 m each) in mixed forests of sugi (*Cryptomeria japonica*) and hinoki (*Chamaecyparis obtusa*) in Kami City, Kochi Prefecture. Two factors were set for establishing the survey plot: cutting treatments (qualitative thinning and line thinning) and elapsed years (immediately, 5 years, and 10 years) after thinning with two repetitions. The forest condition of the survey plots is shown in Table 1. In addition, the survey plots were examined beforehand to ensure the

candidate sites were not biased as far as possible in terms of area, slope orientation, inclination, and understory vegetation coverage. The thinning method applied to the plots was line thinning in which one out of every four rows of planted trees was cut; that is, one cut row with three remaining rows. On the plot where the qualitative thinning was done, selected thinned trees were extracted by simple cable system using a mini-forwarder equipped with a winch.

Table 1. Site description of study stands

Cutting treatment /Elapsed years after thinning	Altitude, m a.s.l.	Inclination, degrees	Slope orientation	DBH, cm	Tree height, m	Branch height, m	Density, tree ha <sup>-1</sup>	Thinning percentage	Sugi composition	Hinoki composition
Line thinning/immediately 1	238.6	16.0	167	28.9	25.2	8.8	500	44.4%	100%	0%
Line thinning/immediately 2	230.1	13.8	178	33.7	24.6	12.0	1,200	14.3%	83%	17%
Line thinning/5 years 1	737.3	34.7	151	27.4	20.5	12.3	1,100	52.2%	91%	9%
Line thinning/5 years 2	734.7	30.3	160	30.6	22.1	11.2	900	43.8%	100%	0%
Line thinning/10 years 1	718.8	27.5	138	23.4	16.2	8.9	1,500	44.4%	100%	0%
Line thinning/10 years 2	729.1	25.0	137	23.5	15.4	6.8	1,000	65.5%	100%	0%
Qualitative thinning/immediately 1	474.8	34.4	106	23.5	16.9	11.9	900	43.8%	89%	11%
Qualitative thinning/immediately 2	463.6	30.3	140	33.1	23.5	12.5	800	38.5%	75%	25%
Qualitative thinning/5 years 1	467.2	38.0	81	29.2	24.5	12.1	700	65.0%	100%	0%
Qualitative thinning/5 years 2	461.1	44.8	78	36.5	24.4	11.2	800	50.0%	100%	0%
Qualitative thinning/10 years 1	537.2	34.0	94	26.2	23.6	15.7	1,700	22.7%	65%	35%
Qualitative thinning/10 years 2	523.9	27.0	131	27.3	25.7	15.8	1,400	22.2%	64%	36%

## 2.2 The degree of understory vegetation

The coverage of understory vegetation was measured on four days (2015/11/11, 12/9, 12/24, 2016/1/11) for all 12 plots. To measure the vegetation coverage, a wooden frame (1.0 × 1.0 m) was placed on the forest floor and the coverage was evaluated visually by distinguishing between vegetation and litter (Hoshino 2010). Measurements were taken at four points per plot, giving 48 measurements in twelve plots. Each measurement point was selected within a 5 × 5 m square of homogeneous vegetation cover from one plot (10 × 10 m) divided into four parts. The measurement point was close to the center of each square, without rocks and large fallen trees.

Two-way ANOVA was conducted on both the understory vegetation and the litter. The two dependent factors were A: cutting treatment and B: elapsed years after thinning. Multiple regression analysis was also performed using the entire light environment indicators described below as explanatory variables, and the coverage of vegetation and litter as objective variables.

### 2.3 Canopy openness

To examine more suitable indicators, canopy openness (CO1: %) was measured using crown projection maps and whole hemispherical photographs. In addition, relative scattered light (SOC, UOC: %) and sky factor (SF: %; Inoue et al. 1996) was calculated from the whole hemispherical photographs. The crown projection maps were created using a direct drawing method (Kamiya 2010). To calculate the area of the crown-covered portion among the plots from the created crown projection maps, CO1 (Crown Openness; %) was obtained using a planimeter (Planix 10S). CO1 is the rate of crown-projected area from the total area of each plot (100 m<sup>2</sup>).

A single lens reflex camera (Nikon D 5300) and a fisheye lens (Sigma single focal fisheye lens 4.5 mm APS-C) were used to take the hemispherical photographs. The method of Teraoka (1995) was followed for the shooting conditions: cloudy and calm days; camera leveled at breast height (1.3 m); ISO film speed, 100; shutter speed, 1/100; lens aperture, f/2.8. Relative scattered light (SOC: %, UOC: %) and canopy openness (CO2: %) were calculated using RGB Fisheye ver2.01 (Ishida 2004), and sky factor (SF: %) using LIA32 ver0.378 (Yamamoto 2008) from the hemispherical photographs.

Photographs were taken two times for each combination of factors and treatments. The photographs were first taken on 24 and 25 December, 2015, with one shot at the center of each plot (12 photographs). To obtain more accurate data, photographs were taken a second time from December 23 to 24, 2016, with four shots per plot. Furthermore, every measurement point was re-shot at the center of a square (5 × 5 m) created by dividing one plot (10 × 10 m) into four equal parts. However, at the time of the second survey, the photographs were taken with a front cap adapter attached, narrowing the field of view to up to 75 degrees. Four photographs were taken in each of the 12 plots to give 48 photographs.

## 3. RESULTS AND DISCUSSION

### 3.1 Measurements of understory vegetation, litter, canopy openness, and relative illuminance

Figure 1 shows the understory vegetation and litter coverage, canopy openness (CO2), and relative scattered light measurements (SF, SOC, and UOC). Significant differences were observed in the coverage of understory vegetation for factor A: thinning method ( $P = 0.01$ ), factor B: elapsed years ( $P < 0.01$ ), and  $A \times B$  interaction ( $P < 0.01$ ). With factor A, the value for A1 (line thinning) tended to be greater than that for A2 (qualitative thinning) ( $0.216 \pm 0.020$  (mean  $\pm$  standard error; the same applies hereafter) and  $0.135 \pm 0.034$ , respectively,  $n = 24$ ). With factor B, the value for B2 (5 years elapsed) tended to be greater than that for B3 (10 years elapsed) ( $0.243 \pm 0.405$  and  $0.115 \pm 0.218$ ,

respectively,  $n = 16$ ). However, it is presumed that the effect of factor B did not result from the elapsed year but from the topographic condition of the plot. In addition, for the convenience of the schedule, we were forced to measure the coverage of understory vegetation in winter in this study. However, Hoshino (2010) recommended that vegetation cover should be measured from early summer to fall. Therefore, the survey needs to be conducted again.

Significant differences in litter coverage were observed for factor A ( $P < 0.01$ ), factor B ( $P = 0.02$ ), and  $A \times B$  interaction ( $P < 0.01$ ). With factor A, the value for A2 tended to be greater than that for A1 ( $0.834 \pm 0.168$  and  $0.694 \pm 0.220$ , respectively,  $n = 24$ ). With factor B, the values for B2 and B3 tended to be greater than that for B1 (immediate) ( $0.891 \pm 0.117$ ,  $0.744 \pm 0.225$ , and  $0.657 \pm 0.198$ , respectively,  $P < 0.05$ ,  $n = 16$ ). In terms of the relationship between lower vegetation and litter, Yokoi et al. (2008) reported that coverage of understory vegetation decreases as litter coverage increases, and the same tendency was observed in this study.

There was no significant difference between factor A ( $P = 0.99$ ), factor B ( $P = 0.19$ ), and  $A \times B$  interaction ( $P = 0.23$ ) according to CO1 from the crown projection maps.

There were no significant differences in the indicators calculated from the hemispherical photographs (SF, CO2, SOC, UOC) of the measurements in 2015 with a small number of repetitions ( $P = 0.05$ ), except for SF ( $P > 0.05$ ). However, in the 2016 measurements with a large number of repetitions, a significant difference was observed in all the indicators ( $P < 0.10$ ). No significant difference was observed in the 2015 measurements for factor A, but the values tended to be greater for A1 than for A2 in any of the indicators. Although the same tendency was observed in the measurements for 2016, there was a significant difference between SF and CO2 ( $P < 0.01$ ). In the 2015 measurements for factor B, there was a significant difference only in SF, and B1 tended to be greater than B2 and B3 ( $P < 0.01$ ). In the 2016 measurements, significant differences were observed in all the indicators ( $P < 0.01$ ), and the average values tended to be  $B1 > B3 > B2$ .

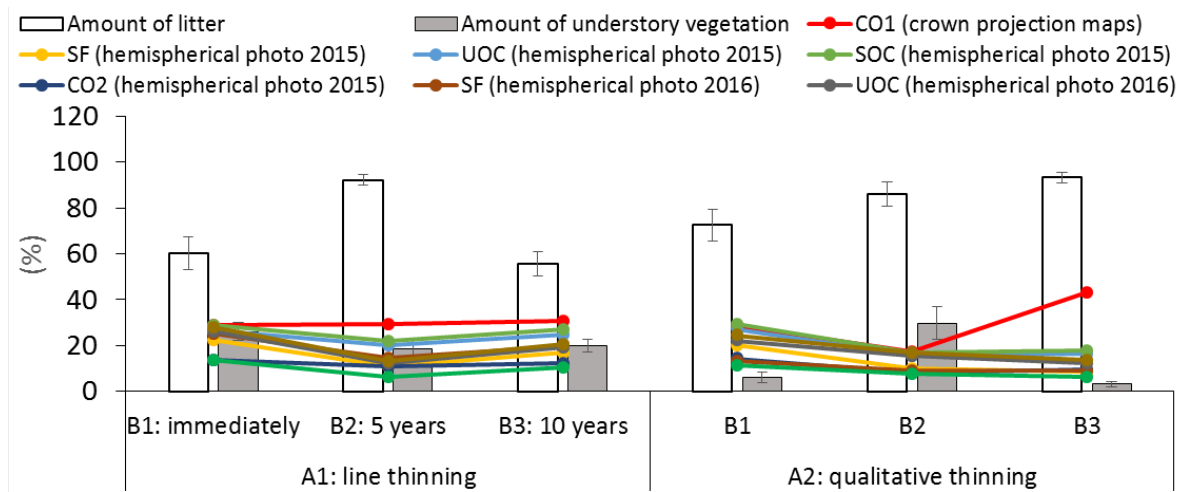

Figure 1. Measurements of understory vegetation, litter, canopy openness, and relative illuminance  
 Note: Vertical bars are SE (N=8).

### 3.2 Relationship between coverage of understory vegetation, and all indicators (CO1, SF, CO2, SOC, and UOC)

Figure 2 shows the relationship between the coverage of the understory vegetation and CO1 using the crown projection maps. There was a negative correlation between lower vegetation and CO1 ( $P = 0.02$ ). In other words, the tendency that understory vegetation decreases as crown openness decreases was confirmed. From this result, the effect of thinning could be evaluated to some extent by using CO1 from the crown projection maps.

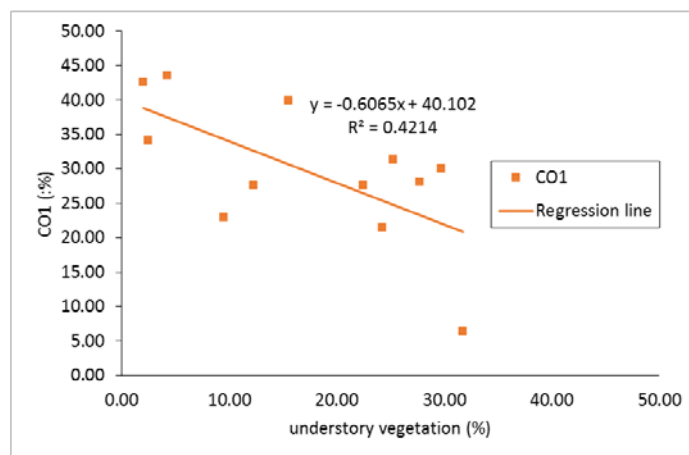

Figure 2. Relationship between understory vegetation and CO1 using crown projection maps

Figures 3 and 4 show the relationship between the coverage of the lower vegetation and



each indicator calculated from the whole sky photographs shot in 2015 and 2016. There was almost no significant correlation between all the indicators. From this result, we believe that the indicators in the whole sky photographs are not suitable for thinning evaluation.

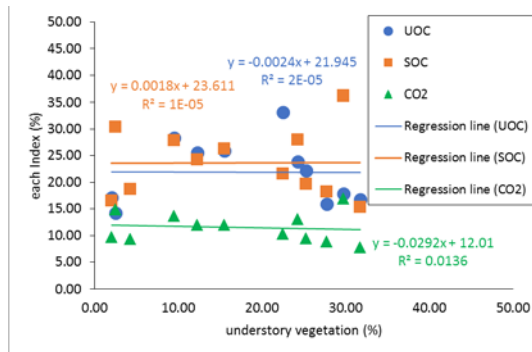

Figure 3. Relationship between understory vegetation and each indicator (using hemispherical photographs shot in 2015)

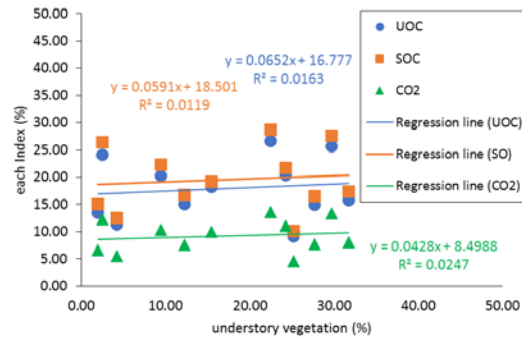

Figure 4. Relationship between understory vegetation and each indicator (using hemispherical photographs shot in 2016)

### 3.3 Conclusions

From the results of this study, we believe the indicators based on the crown projection maps are more suitable as an evaluation indicator after thinning rather than the indicators from the hemispherical photographs. However, there were problems investigating the skies in 2016 making it impossible to obtain accurate data, so the investigation needs to be conducted again. In addition, a survey of lower vegetation will be needed at another time. In future work, we would like to find additional simpler indicators by conducting additional surveys and continuing surveys.

### ACKNOWLEDGEMENTS

We thank Kami Forestry Owners' Cooperative and Mr. Takumi Okamoto for his kind support, allowing us to use the survey site, and providing information. Mr. Satoru Wakushima of the Hiroshima Prefectural Technology Research Center, Forestry Research Center gave us very useful advice in carrying out the research.

### REFERENCES

Forestry Agency (2016) Annual Report on Forest and Forestry in Japan Fiscal Year 2015 (Summary), 33 pp., Ministry of Agriculture, Forestry, and Fisheries (MAFF), Tokyo. Online, <http://www.rinya.maff.go.jp/j/kikaku/hakusyo/27hakusyo/attach/pdf/index-1.pdf>.

Accessed on June 8th, 2017.

- Hoshino, Y. (2010) “Measurement of vegetation” *Investigation Methods for Forest Environment, Hakyu-Sha*, 43–46.\*
- Inoue, A., Okamura, A., Mizoue, N., Teraoka, Y., Imada, M. (1996) “Estimation of relative illuminance in forests using hemispherical photographs” *Forest Planning*, 2: 125–129.
- Ishida, M. (2004) “RGB Fisheye ver2.01” Gifu Field Science Center, Faculty of Applied Biological Sciences, Gifu University. Online, (<http://www1.gifu-u.ac.jp/~ishidam/RGBFisheye.htm>). Accessed on May 29th, 2017.
- Kamiya, T. (2010) “How to create tree location maps and canopy projection maps” *Investigation Methods for Forest Environment, Hakyu-Sha*, 57–58.\*
- Sano, T. (1997) “Relationship between relative insolation estimated from hemispherical photographs and height growth of *Cryptomeria japonica* and *Chamaecyparis obtusa* planted under canopy gaps in a *Cryptomeria japonica* man-made forest” *Applied Forest Science*, 6, 87–90 (in Japanese).
- Teraoka, Y. (1997) “The problem in taking fisheye photographs of canopy for evaluating an open rate” *Kyushu J. For. Res.*, 48, 29–30 (in Japanese).
- Watanabe, Y., Suzuki, Y., Goto, J., Sakai, H. (2014) “Change of soil movement on man-made forest by different cutting treatments for two years” *J. Jpn. For. Eng. Soc.*, 29, 149–156 (in Japanese).
- Watanabe, Y., Suzuki, Y., Sakai, H. (2017) “Variation of surface soil movements in plantation forest subject to potential future tree management practice: Observations on surface organic matter, vegetation cover and sediment discharge over a three year period” *J. Jpn. For. Soc.*, 71, 481–490 (in Japanese with English summary).
- Yamamoto, K. (2008) “LIA32 ver0.378” Graduate School of Bioagricultural Sciences, Nagoya University. Online, (<http://www.agr.nagoya-u.ac.jp/~shinkan/LIA32/>). Accessed on May 29th, 2017.
- Yokoi, S., Igawa, K., Watanabe, H. (2017) “Subsurface vegetation of Japanese cypress forests 3 to 5 years after thinning” *Gihu, For. Res.*, 37 (in Japanese).

\*: The titles are a tentative translation from the original Japanese.

## P-21

### **The Temiar Community in Kelantan, Peninsular Malaysia: Their Socioeconomic and Culture Values**

Wan Nur Farinie Wan Zee<sup>\*1</sup>, Pakhriazad Hassan Zaki<sup>1</sup>, Mohd Hasmadi Ismail<sup>2</sup>, Nur Syuhada Nawi<sup>1</sup>, Nur Afifah Mohamad Amran<sup>1</sup>, Md. Damiri Md. Sairi<sup>1</sup> and Nor Azmi Baharom<sup>1</sup>

<sup>1</sup>Department of Forest Management, Faculty of Forestry, Universiti Putra Malaysia

<sup>2</sup>Department of Forest Production, Faculty of Forestry, Universiti Putra Malaysia

\*Corresponding author: Tel: +6016-3699700 E-mail: [wfarinie@yahoo.com](mailto:wfarinie@yahoo.com)

**Abstract:** Forests in Malaysia have a wide range of roles and functions. It is highly important to the communities to meet their needs in terms of food, shelter, traditional medicine and culture values. The increasing rate of forest degradation and unplanned development is one of the factors that have threatened the life of sub group of orang asli from Temiar community. This study was conducted in Kampong Manok, state of Kelantan, Malaysia. The objectives were to identify the socioeconomic activities conducted by the Temiar community and to determine the monetary value from such activities. A total of 100 respondents were identified. Information was gathered through questionnaires distribution. In-depth interview and site observation were also conducted. The data were analyzed by using IBS SPSS Statistic Version 22.0. The study revealed that majority of Temiar community involved in agroforestry activities (46%), forest product gathering (28%), logging sector (14%), traditional handicraft (8%) and other sector (4%) such as trading non-timber forest products. The highest monetary value of the community was from 401MYR to 700MYR per month and the lowest monetary value ranged between 50MYR-300MYR per month.

**Keywords:** Socioeconomic characteristics, Orang Asli, Temiar community, Kelantan, Peninsular Malaysia

#### **1. INTRODUCTION**

Aboriginal people practicing unique traditions, by retain social, cultural, economic and political characteristics that are distinct from those of the dominant societies in which they live. According to Aboriginal Peoples Act 1954, aboriginal people defined in three definitions 1) any person whose male parent is or was a member of an aboriginal ethnic

group, who speaks an aboriginal language and habitually follows an aboriginal way of life and aboriginal customs and beliefs, and includes a descendant through males of such persons; 2) any person of any race adopted when an infant by aborigines who has been brought up as an aborigine, habitually speaks an aboriginal language, habitually follows an aboriginal way of life and aboriginal customs and beliefs and is a member of an aboriginal community or ; 3) the child of any union between an aboriginal female and a male of another race, provided that the child habitually speaks an aboriginal language, habitually follows an aboriginal way of life and aboriginal customs and beliefs and remains a member of an aboriginal community. In Malaysia, aboriginal peoples known as Orang Asli. The term Orang Asli acts as collective term that can be deciphered as “original peoples” or “first people”; it is replaced the term “aborigines” used by the British colonial administration (Gomes, 2004). Orang Asli are communities that live within, or attached to geographically distinct traditional habitat or ancestral territories. They are the holders of unique languages, knowledge systems and beliefs and own invaluable knowledge of practices for the sustainable management of natural resources. The Orang Asli use traditional approaches in their daily activities which are considered as primitive with oriented economy enough for life. They are also having a special relation towards their traditional land. Their inherited land has an essential importance for their collective physical and cultural survival as peoples. Majority of Orang Asli are forest-dweller or nomads and live in the forest or fringes of areas. They normally live in remote areas of the forest, therefore they are considered materially poorer and less developed compared to the others. Some of subgroups of Orang Asli live together or in bands. Others have their settlement in villages and live much like the Malays.

### **1.1 Division of Orang Asli in Peninsular Malaysia, Malaysia**

There were about 141,230 Orang Asli in Peninsular Malaysia (JAKOA, 2012), where the classifications of the tribes were based on the morphology, culture, languages and also based on their geographical locations for the convenience of administration. The division of Orang Asli in Malaysia divided by three main groups (JAKOA, 2011). Orang Asli are divided into three major group namely as Negrito (or Semang), Senoi and Proto-Malay. These three major groups are also constituent of 18 small sub-group or ethnics (Bellwood, 1997; Nicholas, 2000; Nicholas, 2005). Firstly is Negrito (sub-groups: Bateq, Kensi, Kintak, Lanoh, Jahai, and Mendriq). Secondly is Senoi (sub-groups: Che Wong, Mah Meri, Temiar, Jah Hut, Semaq Beri and Semai). Lastly is Proto-Malay (sub-groups: Temuan, Semelai, Jakun, Orang Kanaq, Orang Kuala, and Orang Seletar). The Orang Asli comprises only 0.6% of the total population in Malaysia.

Senoi is the largest ethnic group constituting about 54% of the total population of Orang Asli. The second one is Proto-Malay at 43% and lastly is Negrito where is consist of only 3%. The Negrito people has characteristics of dark-skin and curly hair. They were the first occupants of South-East Asia and lives as hunters-gatherers. On the other hand, the Proto-Malay has brighter skin and straight hair compared to the Negrito. The Proto-Malay people work as farmer-traders (Fix, 1995). However, Senoi have a variety of skin colour and wavy hair, living as both hunter-gatherers and traders. They were also thought as a generation from mixture between the Negrito and an East Asian population.

## **1.2 The Temiars**

Temiar community is sub-group of Senoi group. Senoi group mainly distributed from the middle to northern part of the Peninsular Malaysia. A study by Baer (1999), it has been estimated the Senoi group reach Peninsular Malaysia during the second wave of migration about 8,000 years ago from the mountain areas of Cambodia and Vietnam. In Malaysia, the Senoi lives along the hilly slope of the main range. The different group of Senoi people are to be found living adjacent to the Malay traditional villages in the state of Selangor, Negeri Sembilan, Melaka and Johor (Salleh *et. al.*, 1993). Senoi people have similar physical characteristics of Mongoloid but there are some believed that Senoi people are the descendants of Australoid from Australia and Veddoid from South India (Fix, 1995). Temiar were slightly tall, somewhat in lighter skin colour, wavy hair, and were taller (Benjamin, 1993). Their language has been labelled as Aslian, “speakers of Austroasiatic, Mon-Khmer languages” (Roseman, 1991). Traditionally, the Temiar practised hunting and gathering, and also swidden agriculture. Temiar people are also traditionally engaged in free trade activity where is they are the main suppliers of the forest produce. In terms of religion and beliefs, Senoi people remain as strong believers of their religion of psychotherapy (Nicholas, 2000). The religion of psychotherapy also called as “Senoi Dream Therapy”. The Temiars believes that dreams are a mythical experience in which the person’s soul wanders about the forest in search of guidance. Normally, they communicate with the spirits guides through theirs dreams and even their dance and songs also inspired by dreams. Senoi are mostly practised their animistic ways in their life style but there are some of them like Temiar sub-group have converted into Islam and practice Islam in their way of life. Moreover, to control any of threats, the Senoi people will follow protection from the shaman or called as Halaak. Halaak is able to connect with supernatural beings, as well as “possess” one or more of them as spirit guides or helpers (called gunig). Senoi people believe that the halaak, with the help of their gunig, could be shields and protect the people from unseen threats. Through the gunig, the halaak also attains their knowledge about how to cure illnesses,

to evade natural disasters, and so many more problems.

## 2. METHODOLOGY

This study was conducted at Kampong Manok, in state of Kelantan in Malaysia. Two kind of data collection were applied which are primary data and secondary data. Primary data collected by questionnaire survey, in-depth interview and site observation. There are two types of data were collected in primary data, 1) socio-demographic data and 2) occupation of Temiar community including collection of non-timber forest products (NTFPs) activities. Secondary data were obtained based on books, scientific journals, brochures, articles, literature review and previous study, official documents obtained from Forestry Department, and Annual Report of Orang Asli Affairs Department (JAKOA). The sample size was 100 respondents, and the data analyzed by using IBS SPSS Software Version 22.0.

## 3. RESULTS AND DISCUSSION

The results are presented namely as: the socioeconomic activities and monetary value of the respondents. The main occupation of the respondents was involved in agroforestry activities which is consisting of 46%. The second highest percentage of occupation was forest product gathering whereby consisting of 28%. Third occupation was logging sector where represented 14%. The fourth is handicraft sector, which comprises 8% and last occupation was others sectors came out with 4%.

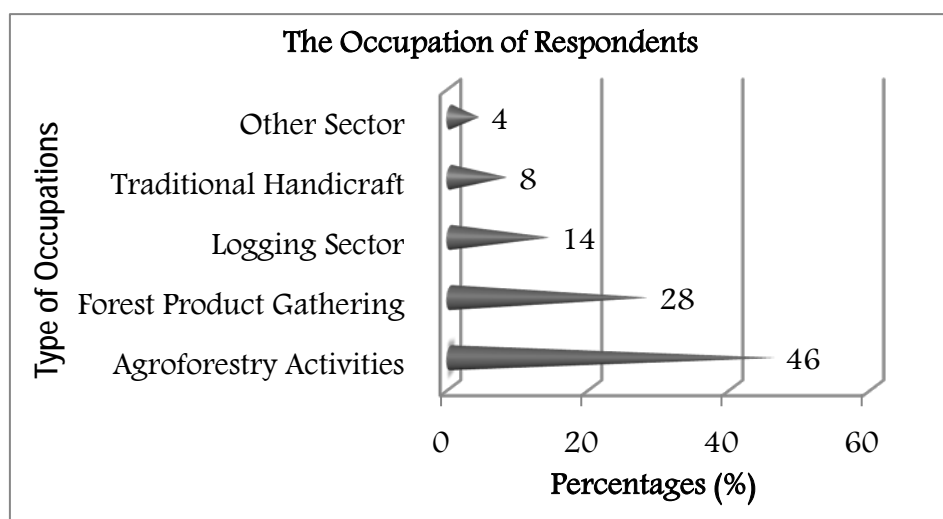

Figure 1: The Occupation of the Respondents (%)

Figure 2 indicate the highest range of income was 401MYR-700MYR where is 56% and the lowest range of income was 50MYR-300MYR with 33%.

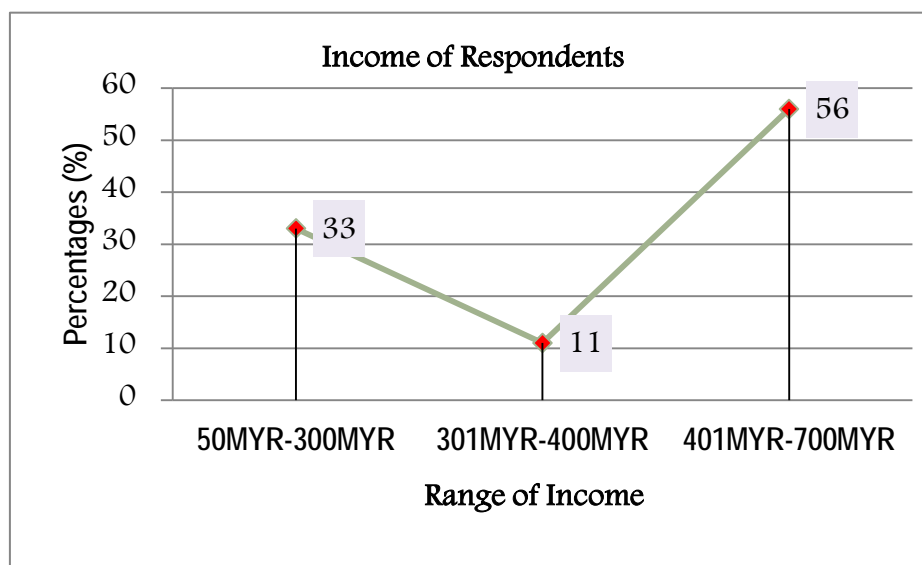

Figure 2: Income of Respondents

The Temiar community in Kampong Manok are also involved in collecting of non-timber forest products (NTFPs). There were two types of forest products collected by Temiar community which is namely as flora and fauna. Flora species collected are *Labisia pumila*, *Eurycoma longifolia*, *Styrax benzoin*, *Zingiber officinale*, *Archidendron bubalinum*, *Parkia speciosa*, *Goniothalamus macrophyllus*, *Smilax myosotiflora*, *Aquilaria malaccensis*, *Dialium indum*, *Baccaurea motleyana*, *Garcinia atroviridis*, *Piper betle*, *Bouea oppositifolia*, *Eleiodoxa conferta*, *Manihot esculenta*, Calameae, Bambuseae, and Orchidaceae. Fauna species collected are *Ophicephalus striatus*, *Notopterus chitala*, *Manis javanica*, *Gallus*, Frog, Birds, and Snake.

#### 4. CONCLUSION

The findings provide important new information on the activities carried out by Temiar community to generate their income and the monetary value of Temiar community in Kampong Manok.

#### REFERENCES

- Baer, A. (1999). Health, Disease and Survival: A Biomedical and Genetic Analysis of the Orang Asli of Peninsular Malaysia. Subang Jaya: Center for Orang Asli Concerns.
- Bauer, C. (1991). Kensiew: A northern aslian Language of Southern Thailand. In P. Surin, Preliminary report of excavations at Mon-Khiew Cave, Krabi Province, Sakai Cave, Trang Province and Ethno-archeological research of Hunter-Gatherer Group so

- call Sakai or Semang at Trong Province (pp.310-335). Bangkok: Silpaorn University.
- Bellwood, P.S. (1997). Pre-history of the Indo-Malaysian Archipelago. Honolulu, Hawaii: University of Hawaii Press.
- Benjamin, G. (1993). Danger and Dialect in Temiar Childhood. Department of Sociology, Singapore: National University of Singapore.
- Fix, A.G. (1995). Malayan Paleosociology: Implications for patterns of genetic variation among the Orang Asli. *American Anthropology*, 313-323.
- Hood, S. (1993). Man, Forest and Spirits: Images and Survival among Forest-Dwellers of Malaysia. *Journal Southeast Asian Studies*, 30(4).
- JAKOA. (2011). Annual report of Department of Orang Asli Affairs. Kuala Lumpur: Jabatan Kemajuan Orang Asli.
- Laws of Malaysia, Act 134. Aboriginal Peoples Act 1954 revised 1974.
- Nicholas, C. (2000). The Orang Asli Contest for Resources: Indigenous Politics, Development and Identity in Peninsular Malaysia. Subang Jaya: International Work group for Indigenous Affairs for Centers of Orang Asli Concern.
- Nicholas, C. (2005). Integration and modernization of the Orang Asli: the impact on culture and identity. 1<sup>st</sup> International Conference on the Indigenous People. Kuala Lumpur.
- Roseman, M. (1991) Healing Sounds from the Malaysian Rainforest: California.



## P-22

### **Managing of Malaysian Tropical Rainforest: Issues and Challenges**

Md Damiri, M.S. \*, Pakhriazad, H.Z., Mohd Hasmadi, I., Paiman, B., Wan Nur Farinie, W.Z., Nur Syuhada, N., Nor Azmi, B. and Nur Afifah, M.A.

Department of Forest Management, Faculty of Forestry, Universiti Putra Malaysia.

\*Corresponding author; Email: [damirimlgc@yahoo.com](mailto:damirimlgc@yahoo.com)

**Abstract:** Deforestation activities can seriously damaging our environment. It is caused by the growing demand for forest products, conversion of forest to agriculture as the human population continues to expand and unplanned urban development. Deforestation is a major concern and unavoidable as the country is still rapidly developing. Government policies is to increase the coverage of forest protected areas, improve the management of production forests for the supply of sustainable timber, and restore degraded areas especially where there is need to maintain critical forest linkages. Malaysia is committed in implementing Sustainable Forest Management (SFM). Therefore, criteria for the SFM introduced by the government had reflect the national context and the specific ecological and environmental conditions, as well as social, economic, political, cultural and spiritual dimensions.

**Keywords:** Deforestation, forest management, sustainable, Selective Management System and harvesting.

#### **1. INTRODUCTION**

Malaysia is composed of West Malaysia (Peninsular Malaysia), and East Malaysia consisting of the states Sabah and Sarawak. Responsibilities for forestry are divided between the federal and state governments. The forestry departments of each state are responsible for regulating forest exploitation and management. The departments of the 11 states of Peninsular Malaysia come under the Forestry Department of Peninsular Malaysia, while the departments of Sabah and Sarawak are under their own jurisdiction. Expansion of timber, pulp and agricultural plantations (which include oil palm and rubber) has been the main driver of forest loss in the country (Hoare, 2015). One of the most important forest uses is logging or timber harvesting. Logging is the most lucrative forest use and can cause severe direct and indirect environmental impacts. This analysis evaluates the impacts of logging on biodiversity in tropical forests based on a thorough

review of the literature and on the best expert opinion. Forests will continue to be harvested and timber harvesting will continue to be an important component of sustainable forest management. This is a reality we cannot escape. Therefore, as this practice continues we need to assure ourselves that it is ecologically and environmentally sustainable. The term of biodiversity into components (landscapes, ecosystems, communities, species/populations, and genes) and attributes (structure, composition, and function). Biodiversity objectives can and should be established within production forests. In many cases the logging itself is not the major cause of biodiversity loss, but rather the indirect effects, often promoted by the presence of roads, (for example, hunting, forest fires, and the likelihood of deforestation) represent the major environmental threats. From a biodiversity maintenance perspective, natural forest management is preferable to virtually all land-use practices other than complete protection. Forests that are carefully managed for timber will not replace protected areas as storehouses of biodiversity, but they can be an integral component of a conservation strategy that encompasses a larger portion of the landscape than is likely to be set aside for strict protection.

## **2. METHODOLOGY**

Methodology used for this purpose was visited on site and observed the felling operation conducted by logging operators in the designated area. The most common logging systems in Peninsular Malaysia include; (i) ground- based system using a “cable skidder” and (ii) cable winching system called “log fisher”. Log fisher is an excavator based hydraulic cable winching system that can winch logs up to 300 meters. While cable skidders are normally used only on gentle ground, log fishers can be applied regardless of slope conditions. Saharudin et al. (2004) and Norizah et al. (2012) found that log fishers have a higher productivity than cable skidders where ground slope exceeds 20 degrees. However, log fishers have higher machine and operating costs than cable skidders. Another unique difference between the two logging systems in Malaysia is that “skid trail” construction is mandated by the government for skidding operations, whereas log fishers do not rely on skid trails. In addition, according to the forest regulations in Malaysia, the total length of skid trails from any log landing should not exceed 300m.

Once a harvest area is rasterized, timber flows from individual tree locations to landing and then to the final destination through road network can be represented by series of links developed between grid cells (i.e., nodes). Some grid cells represent timber volume and location (i.e., timber nodes), others may represent locations of skid trails, landings, or forest roads. Links between grid cells may represent skidding

activities, log fisher operations, or truck transportation. In the case of skidding activities, links are attributed with both variable and fixed costs representing skidding and skid trail construction costs, respectively. For log fisher operations, only variable cost will be assigned to the link. Costs associated with each activity are estimated based on a productivity study conducted by Norizah (2013). However, there has not been any productivity study on timber transportation so far in Peninsular Malaysia. Thus, hauling cost was estimated for this study according to expenses allotted for log transportation by forest concessionaire. Road construction cost was estimated using the past study by Mohd Hasmadi et al. (2008). All the cost data used in this study are summarized in bellow.

#### **Cost data used in this study for timber harvesting activities.**

---

(i) Stump-to-landing:		
(i) Skidding cost with cable skidder		MYR 0.06/m <sup>3</sup> /m
(ii) Skid trail preparation		MYR 0.5/m
(iii) Winching cost with log fisher		MYR 0.13/m <sup>3</sup> /m
(ii) Timber transportation:		
(i) Hauling cost		MYR 0.096/m <sup>3</sup> /km
(ii) Road construction cost		MYR 18/m

---

\*MYR 1.0 is approximately equivalent to USD 0.44 (2017 March)

### **3. STUDY AREA**

Malaysia has around 22.2 million hectares (ha) of forested land (FAO, 2015), which constitutes to 67.6% of the total land area. Around 20.2 million ha of the forested land is primary or otherwise naturally regenerated forest, and around 2.0 million ha is planted forest. The reserve area is a buildup of 290,000 ha of land and about 146,000 ha of the area is made up of virgin forest. The Perak State Forestry Department (PSFD) is responsible for the management of the natural forest in the PRF within the Perak State FMU covering 991,433 ha or about 47.2% of the state's total land area of 2.1 million ha. The administration of the FMU is divided into five forest districts namely the South Perak, Kinta/Manjung, Kuala Kangsar, Larut-Matang and Hulu Perak Forest Districts. The PSFD was still committed to the management of the natural forest in the PRF within the State FMU on a sustainable basis. The inland forest is managed under a Selective Management System (SMS) on a 30-year rotation period. Under the Ninth Malaysia Plan (2006-2010), the Annual Allowable Cut (AAC) for the Perak State FMU

had been set at 7,770 ha. A Forest Management Plan (FMP) covering the period from 2006 to 2015 had been completed and presented during the audit.

In Malaysia, timber can be harvested from 3 different sources (NEPCon, 2016); (i) Natural (or semi-natural) forests. Natural forests are under state ownership, except for some alienated (privatised) land where forest clearance is permitted for private use. For the forests under state ownership a basic distinction can be made for forests inside the Permanent Reserved Forests (PRF) and on state land outside the PRF. The state has the management rights of these forests, but these are transferred to private parties via private concessions in the PRF, or harvesting permits in state lands; (ii) Timber plantations. Timber plantations are often established in the PFR, where management rights of the state are transferred to private parties via private concessions. Timber plantations are rarely established on state land, although state land which has a former status of PFR could hold timber plantations. Here the state has the management rights, which are transferred to private parties via harvesting permits. Timber plantations are seldom established on private land, since it is usually more profitable to grow oil palm or rubber (for latex), and (iii) Agricultural areas. Rubber plantations on agricultural areas account for approximately 1 million hectares of the total area of planted forest, being the main timber source from agricultural areas. This timber originates mainly from rubber plantations that are being cleared for oil palm or for another rotation of rubber. The land is primarily privatized (alienated) land, but to a limited extent also state owned land inside and outside the PFR. About 22% of the Permanent Reserved Forest (PRF) is not used for commercial production, but is designated as protected. Such protected forests are managed by the state and include: non-harvestable forest (areas above certain altitudes and slopes), virgin jungle reserves, recreational forest, catchment forest and reservoirs and forest for federal purpose. National Parks, Wildlife & Bird Sanctuaries cover approximately 1.9 million ha of forest. Most production is from natural forest production and clearance of rubber plantations (Hoare, 2015). Malaysian natural forests can be distinguished in three forest types; (i) dry inland forests, accounting for the great majority of the Malaysian forests. Common tree species found in these forests include *Anisoptera*, *Dipterocarpus*, *Dryobalanops*, *Hopea*, *Shorea* and *Parashorea*; (ii) peat swamp forests, with species such as *Gonystylus bancanus* (Ramin), *Durio carinatus* and various *Shorea* species, and (iii) mangrove forests. The Malaysian industry produced in 2014 about 20.5 million metric ton of logs, of which around 17% is exported. Total exports of the main primary timber products have a value of around 3 billion US dollars (ITTO, 2015). Asia is the major export market destination for Malaysia's timber products, notably Japan (plywood being the main product exported) but also others such as India, Thailand and China (logs, sawn wood

and plywood). The US and the EU are other important markets importing significant volumes of wood-based products from Malaysia (plywood, sawn wood and furniture). The US and EU markets are predominantly supplied by Peninsular Malaysia (Hoare, 2015).

#### **4. DISCUSSION**

The best way to assure biodiversity conservation is through the establishment and protection of large, properly located, and well managed reserves and protected areas. In some parts of the world and some types of forest, there should be no logging at all. Existing legislation and regulations should be enforced. Where they do not exist, or are weak they should be created or updated to reflect current conservation and sustainable resource management concerns. Biodiversity conservation is enhanced by setting aside a portion of the area for complete protection. Where logging is to be carried out, reduced- impact logging guidelines (Dykstra and Heinrich, 1996) should be fully implemented by well-trained crews. Researchers need to determine the financial and environmental costs and benefits of the components of reduced-impact logging and various other pre- and post-logging silvicultural activities. Particular attention should be paid to plant and animal species with attributes that render them susceptible to logging-induced extirpation (Martini *et. al.*, 1994, Pinard *et. al.*, 1999). Wildfires need to be controlled. Sude fire control programs will need to include public awareness building as well as implementation of existing technologies and methods. Research is needed for developing cost-effective fire control measures with minimal biodiversity impacts. While continuing to promote and develop community-based wildlife management programs, hunting by loggers and market hunting of slow reproducing species should be prohibited. Enforcing existing laws will in many cases confer substantial protection to species threatened by over-hunting. Training is needed for researchers who will develop biodiversity-sensitive silvicultural methods as well as cost-effective methods for monitoring the environmental impacts of silviculture. Training is also needed for the field crews that are responsible for implementing the recommended practices. Perhaps the most critical shortage is of forestry/conservation "research practitioners" who understand both the broad scientific and the more specific technical aspects of tropical forest management.

The biodiversity impacts of devolution, plantation conversion, certification, forest-based carbon offsets, and global trends in timber markets need to be monitored. Internalized into the decision making process. Legislation and their regulations are an integral part of this process and should be reviewed, updated and enforced. Linkages to the policy must be pursued. All consumptive use affects some component or attribute

of biodiversity, commonly affecting not only the target resource but other factors as well (Redford and Richter, 1999). The population/ species component is most commonly understood to be affected by silvicultural activities although effects, some of which are subtle or cumulative, are undoubtedly often missed even in this comparatively well studied component. Of increasing importance is an understanding of how the community and ecosystem components have been (Runnels 1995) and are being affected by logging and other silvicultural activities. Recognizing that all significant interventions in natural forests have biodiversity impacts, all silvicultural decisions necessarily represent compromises. The biodiversity compromises involved in deciding whether to cut vines, retain seed trees, or enhance seedling establishment by carrying out controlled burns should be informed by Environment Department Papers Overview of Biodiversity Conservation in Relation to Logging and other Silvicultural Treatments research. Unfortunately, very little is known about how tropical forests can be managed in the most biodiversity friendly manner. Researchers have instead focused on enumerating the deleterious environmental impacts of uncontrolled logging by untrained and unsupervised crews. To inform decisions about tropical forest management and to assure that biodiversity is protected to the maximum extent, more research is needed on how to maintain diversity in forests selected for logging. The large and rapidly growing body of literature on ecosystem management in both north and south temperate forests (Kohm and Franklin 1997, Lindenmayer 1999) should provide inspiration and starting points for tropical researchers intent on solving biodiversity related problems associated with forest management. Different intensities and spatial patterns of timber harvesting, along with other silvicultural treatments, result in different effects on the different components of biodiversity. The capacity to mitigate the deleterious environmental impacts of logging and other silvicultural treatments should not be construed as constituting unilateral support for sustainable forest management as a conservation strategy. Furthermore, logging is often the environmentally least damaging of land uses that are also financially viable (Pearce,1999). By focusing on the deleterious environmental impacts of tropical forest management activities, we often lose sight of the fact that from a biodiversity maintenance perspective, natural forest management (that is, maintaining forests as forests) is preferable to virtually all land-use practices other than complete protection.

## **5. CONCLUSIONS**

The fact that nearly all of the studies conducted to date on the biodiversity impacts of logging were carried out after unplanned logging by crews with no training in reduced-impact logging techniques and no incentives to reduce their impacts. In other

words, forests managed primarily for timber, if managed properly, will supplement and effectively extend the conservation estate. Finally, it should be recognized that landscape management is consistent with the ecosystem approach emphasized by the Convention on Biological Diversity (CBD).

## REFERENCES

- Anderson, A.E. and Nelson, J. 2004. Projecting vector-based road networks with shortest path algorithm. *Canadian Journal Forestry Research*, (2004)
- Chung, W., Stuckelberger, J., Aruga, K. and Cundy, T.W. 2008. Forest road network design using a trade-off analysis between skidding and road construction costs. *Canadian Journal Forestry Research*, (2008).
- Chung, W. and Sessions, J. 2003. NETWORK 2000: a program for optimizing large fixed and variable cost transportation problems. In *Proceedings of the 8th Symposium on Systems Analysis in Forest Resources*, Snowmass Village, 27- 30 September 2000, Colorado.
- Definition of “deforestation” from the Cambridge Advanced Learner’s Dictionary & Thesaurus © Cambridge University Press.
- Mohd. Hasmadi, I, Kamaruzaman, J and Muhamad Azizon, J. 2008. Forest road assessment in Ulu Muda Forest Reserve of Peninsular Malaysia. *Journal of Modern Applied Science* 2(3): 101-108, 2008.
- Najafi, A., Sobhani, H., Saeed, A., Makhdom, M. and Mohajer, M.M. 2008. Planning and assessment of alternative forest road and skidding networks. *Croatian Journal of Forest Engineering* 29 (1):63- 73,2008.
- Norizah, K. 2013. Advanced forest harvest operation and road location planning to reduce negative environmental impacts in Peninsular Malaysia. Ph.D Thesis, Universiti Putra Malaysia, Malaysia, 2013.
- Norizah, K., Mohd Hasmadi, I, Kamaruzaman, J. and Alias, M.S. 2012. Operational Efficiency of Rimbaka Timber Harvester in Hilly Tropical Forest. *Journal of Tropical Forest Science*, 24(3): 379- 389, 2012.
- Saharudin, A., Azmi, H. and Mohd-Zamri, R. 2004. *Kajian mengenai kos dan produktiviti sistem pengusahaan hutan bukit di Semenanjung Malaysia*, Jabatan Perhutanan Semenanjung Malaysia, Kuala Lumpur, 2004.

**P-23**

**Impact on Skyline and Lifting Line during Cable Yarding**

Midori UENOHARA<sup>1,\*</sup>, Takeshi MATSUMOTO<sup>2</sup> and Masahiro IWAOKA<sup>2</sup>

<sup>1</sup> Graduate School of Agriculture, Tokyo University of Agriculture and Technology, Fuchu Tokyo 183-8509, Japan

<sup>2</sup> Institute of Agriculture, Tokyo University of Agriculture and Technology, Fuchu Tokyo 183-8509, Japan

\*Corresponding author: Tel: + 81-90-7412-9782 E-mail: [dolly-u-rinko@st.go.tuat.ac.jp](mailto:dolly-u-rinko@st.go.tuat.ac.jp)

**Abstract:** Safety against impact in skyline operations should be considered when designing cable yarding systems. The impact coefficient  $a$  was introduced to model the impact as an extra weight. The objectives of this study are to experimentally determine the value of  $a$  and examine its influence on the factor of safety  $N$  for skyline cables. Previously plotted data of skyline tensions were digitized to be used as basis for the current experimental study, which involves the actual measurement of skyline and lifting line tensions. Accordingly, the values of the impact coefficient  $a$  were calculated, and their corresponding influence on the  $N$  was clarified. The study findings revealed that the value of the  $a$  occasionally exceeds 0.3, which significantly reduces the  $N$  to below the limiting value of 2.7. Therefore, when estimating skyline tension, a greater value of the  $a$  is recommended to ensure safety during cable yarding operations.

**Keywords:** Impact coefficient, Cable yarding, Line tension, Factor of safety

**1. INTRODUCTION**

The tension of skyline ropes during cable yarding operations sometimes becomes greater than that in stationary states because of various reasons. Hence, the impact coefficient  $a$  was introduced to ensure safety against these unexpected tension gains of skyline in cable yarding in addition to the factor of safety  $N$  which ensure safety of usual cables. The impact coefficient  $a$  models the generated impacts as extra weights, which commonly ranges between 0.2 and 0.3, as expressed by Equation (1).

$$T_{max} = \{W + P(1 + a)\} \times \varphi_1 \tag{1}$$

where  $T_{max}$  is the maximum tension of the skyline,  $W$  is the weight of the skyline and operating lines,  $P$  is the static mass of the carriage, chokers and logs,  $\varphi_1$  is the maximum tension coefficient.

However, previous studies in the field indicated that the impact coefficient  $a$



sometimes become greater than 0.3 during yarding operations. For example, Fukuda (1960) reported that the value of  $a$  ranged between 0.408 and 1.024 with sudden braking. Hori (1983) obtained values of  $a$  ranged between 0.3 and 0.38 during loading up and down operations. Irie *et al.* (1962) reported that the measured skyline tension during yarding operations sometimes reached 80% of the wire rope breaking load.

The objectives of this study are to experimentally determine the value of the impact coefficient  $a$  and examine the influence of  $a$  on the factor of safety  $N$  for skyline. Actual values of the impact coefficient  $a$  were calculated using two types of data: one was obtained from the skyline and lifting line tensions experiments and the other was digitized from the previously plotted skyline tension data reported by Irie *et al.* (1962). Accordingly, the influence of  $a$  on the factor of safety  $N$  for skyline was clarified.

## 2. MATERIALS AND METHODS

Skyline tensions were digitized to calculate the impact coefficient  $a$  based on the graphs provided in the study by Irie *et al.* (1962). Figure 1 shows a part of the graphs developed by Irie *et al.* (1962). The circles in the figure indicate the maximum tension of the skyline  $T_{max}$  at each point, and the solid line indicates the static tension  $T$ . The upper and lower limits of error range of these tensions were digitized.

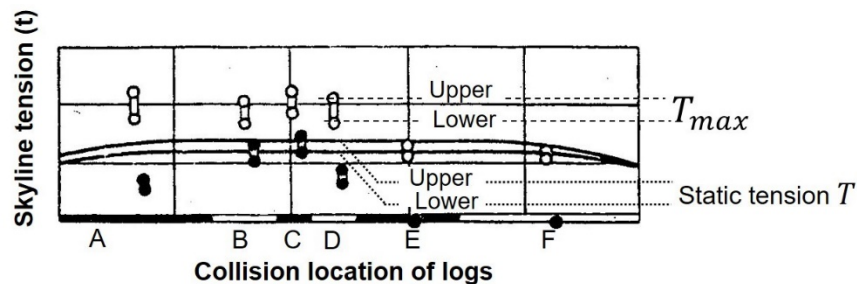

Figure 1 Part of the data provided by Irie *et al.* (1962)

Then, the static load  $P$  and impact load  $P_{imp} = P(1 + a)$  were calculated from  $T_{max}$  and  $T$ , as shown in Equations (2) and (3).

$$P = T / \varphi_0 - 1, \quad (2)$$

$$P_{imp} = T_{max} / \varphi_1 - 1. \quad (3)$$

The impact coefficient  $a$  was calculated from Equation (4).

$$a = P_{imp} / P - 1. \quad (4)$$

To conduct the experiments, a short span cable was set up during the period between October 7 and November 23, 2016 at the campus of the Tokyo University of Agriculture

and Technology (Fuchu, Tokyo). The cable span was 15.82 m with leveled skyline slope, the midspan percent deflection was 0.03. The skyline tension was measured with a load cell (A&D Co. Ltd., LC-1205-T001, 10 kN), which was inserted outside of the cable span. The lifting line tension was measured with a load cell (LC-1205-K500, 4.9 kN), which was hung from the skyline and connected with the lower weight (see Figure 2).

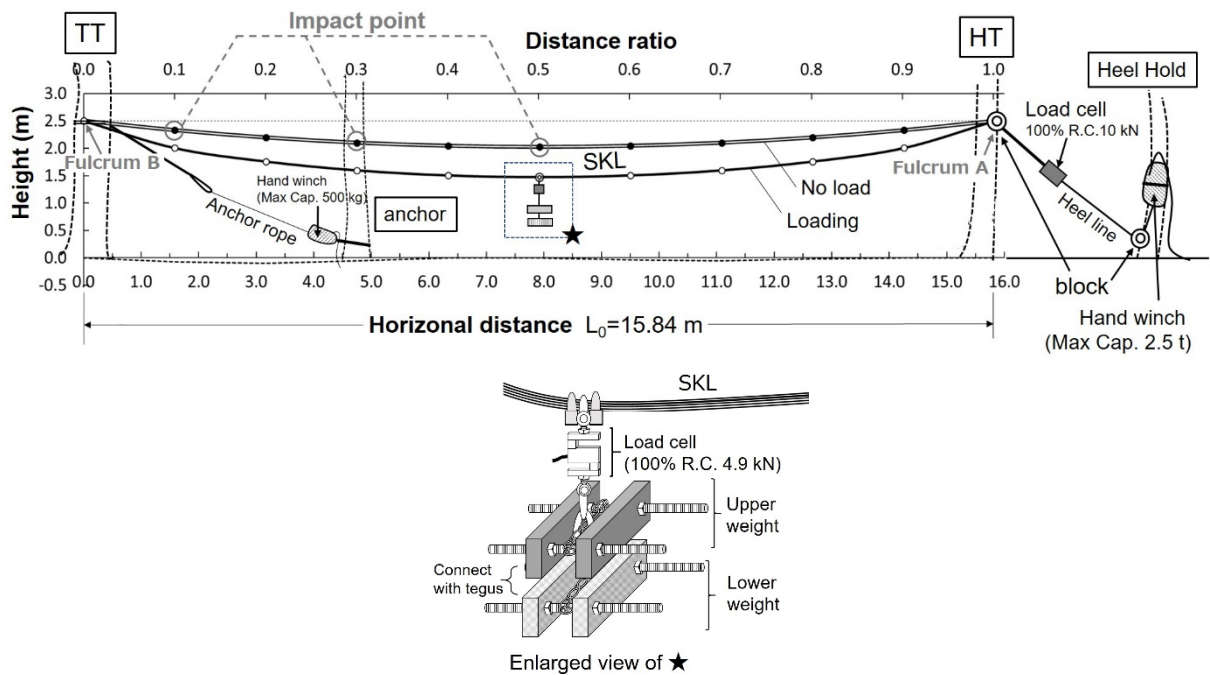

Figure 2 Schematic diagram of the experimental line

Impacts were generated by cutting off a part of the weight to simulate the impact that occurred with the release of logs caught by obstacles such as stumps and convey parts of the ground. The experiments were conducted under nine conditions combining three impact points, at which the distance ratios were 0.1, 0.3 and 0.5, with three different weights of 12.03, 31.56 and 50.76 kg. Hundred replications were conducted for each condition.

### 3. RESULTS AND DISCUSSION

#### 3.1 Impact coefficient $a$

Figure 3 shows the impact coefficients  $a$  calculated from the digitized skyline tensions. The range of the impact coefficient  $a$  calculated from the upper and lower limit of the error ranges were 0.00–3.85 and 0.00–2.64, respectively, and their average values were 1.17 and 0.65, respectively. The ratio of the large impact coefficients that exceeded 0.3 at the upper and lower limit of error ranges were 95% and 80%, respectively.

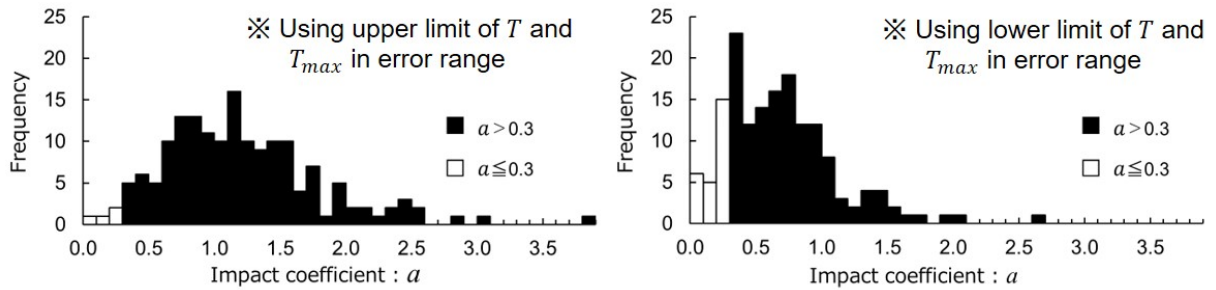

Figure 3 Impact coefficient  $a$  calculated from Irie *et al.* (1962)

Figure 4 shows the impact coefficient  $a$  obtained from the experiments. The range of  $a$  was 0.19–0.42, with an average value of 0.34, while 69% of them exceeded 0.3.

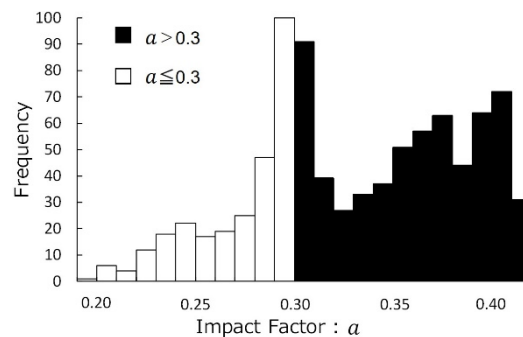

Figure 4 Impact coefficient  $a$  obtained from the experiments

### 3.2 Factor of Safety $N$

The factor of safety  $N$  is defined as the ratio of the maximum tension in the wire rope  $T_{max}$  to the breaking load  $B$ , as expressed by Equation (5).

$$N = T_{max} / B. \quad (5)$$

The value of  $N$  must be greater than 2.7 when the cable span is less than 600 m and 3.0 when the cable span is 600 m or more to ensure operational safety. Figure 5 shows the values of  $N$  calculated based on the digitized skyline tensions. The range and average of  $N$  obtained from the upper limit of error range were 1.03–2.8 and 1.74, respectively, while 96% of them were less than 2.7. The range and average of  $N$  obtained from the lower limit of error range were 1.32–3.9 and 2.07, respectively, while 86% of them were less than 2.7.

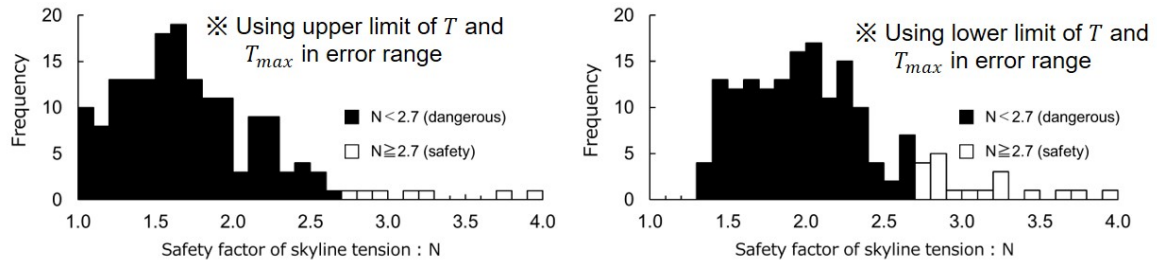

Figure 5 Factor of safety  $N$  obtained from Irie *et al.* (1962)

The lowest factor of safety obtained from the experiments was 7.06, which is high enough to ensure operational safety. However, a relatively high factor of safety was obtained because the experiments involved light loads to avoid the occurrence of any critical situation during the experiments.

### 3.3 Requirements to ensure minimum $N = 2.7$ according to the impact coefficient $a$

Sensitivity analysis was conducted to identify the required conditions to obtain a minimum  $N$  value of 2.7. The results of the analysis showing the required minimum  $\phi$  [mm], minimum  $s$ , and the maximum  $Q$  [kg] according to the impact coefficient  $a$  are presented in Figure 6. For example, when  $a$  is 0.3, the required minimum  $\phi$ , minimum  $s$ , and maximum  $Q$  are 24.0 mm, 0.35, and 1205 kg.

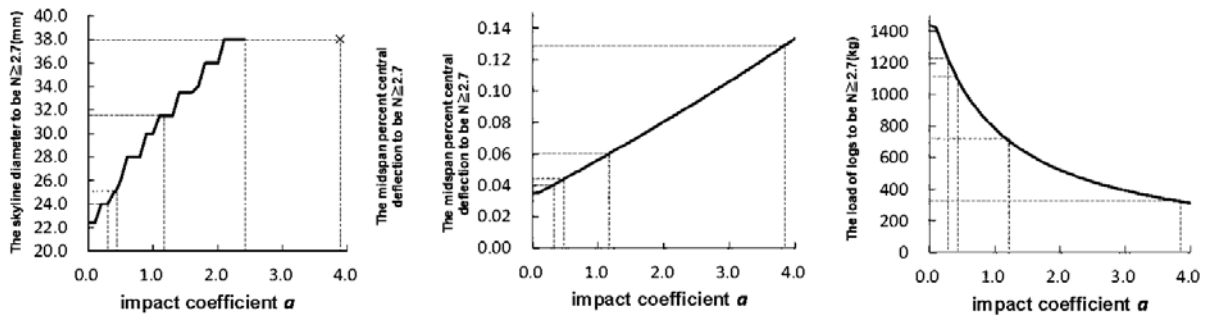

Figure 6 Experimental conditions to ensure minimum  $N = 2.7$

## 4. CONCLUSIONS

The value of  $a$  occasionally exceeds 0.3, which significantly reduces the factor of safety to below the limiting value of 2.7. Therefore, when estimating skyline tension, a greater value of impact coefficient  $a$  is recommended to ensure safety during operations.

## REFERENCES

Fukuda, J. (1960) “Episode of Cableway Experiment (3).” *For. Mech. Inf.* (temporary translated by the author) 83:34–50. (in Japanese with English summary).

- Hori, T. (1983) "Experiment by Field Test Equipment on Impact of Yarding - Impact Effects of Raising or Lowering Loads." *Proc. Mtg. Chubu Br. Jpn. For. Soc.* 31:237–240. (in Japanese with English summary).
- Irie, T. *ed.* (1962) "On the Performance and Tension of Tree Length Logging by Yarder (Part 2)." *Proc. Mtg. Chubu Br. Jpn. For. Soc.* 10: 39–44. (in Japanese with English summary).
- Kato, S. (1955) "Studies on the Skyline Logging Cables for their Planning and Inspection." *Bull. Tokyo Univ. Forests.* 49:1–157. (in Japanese with English summary).

**P-24**

**Ground Pressure Distribution of Forest Machines**

**Hiroko Muneoka<sup>1,\*</sup>, Hidenori Suzuki<sup>1</sup>, Satoshi Yamaguchi<sup>1</sup>, Yuta Inomata<sup>1</sup>,  
Tatsuya Sasaki<sup>1</sup>, and Shigeki Yamashita<sup>2</sup>**

<sup>1</sup> Forestry and Forest Products Research Institute, 1 Matsunosato, Tsukuba, Ibaraki  
305-8687, Japan.

<sup>2</sup> Forestry Mechanization Center, 1445 Neri, Tone machi, Numata, Gunma, Japan.

\*Corresponding author: Tel: + 81-29-829-8285

E-mail: [hirokomuneoka@ffpri.affrc.go.jp](mailto:hirokomuneoka@ffpri.affrc.go.jp)

**Abstract:** This study aimed to show ground pressure distributions of 7 ton- and 12 ton-class crawler-type excavator-based forest machines to determine desired performances of logging roads. The ground pressure distribution was not uniform but concentrated to the positions of track rollers, drive wheel, and idler wheel. The recorded maximum ground pressure of the 7 ton-class machine was larger than the capacity of the soil pressure gauge (500 kPa), where the lengthwise position of the gravity center was 25% from the front end of the contact area. The recorded maximum ground pressure of the 12 ton-class machine was 300 kPa, where the gravity center position was 26% from the front. The results suggest that logging roads could be subjected to more than 500 kPa.

**Keywords:** Ground pressure distribution, Crawler-type forest machine, Logging road

## **1. INTRODUCTION**

Crawler-type excavator-based forest machines are widely used in Japan, and logging roads are often constructed for such machines. In general, the ground pressure of crawler-type forest machines is lower than that of wheel-type ones. The mean ground pressure of excavators with operating weight of 7 and 12 tons ranges from 30 kPa to 40 kPa and from 40 kPa to 50 kPa, respectively. Such values have an insignificant effect on the embankment stability of logging roads in most cases. In reality, however, the ground pressure distribution is not uniform because crawler tracks are not rigid, and the gravity center of a machine moves depending on its front attachment posture. In particular, forest machines often work close to a road edge reaching toward a tree far from the road. In such situations, the road edge can be subjected to considerably high pressure. Therefore, real ground pressure distributions in relation to the gravity center position of

a machine should be clarified to determine desired performances of logging roads and operation safety. The authors measured the ground pressure distributions of 7 ton- and 12 ton-class excavator-based forest machines in several different front attachment postures.

## **2. METHODS**

### **2.1 Relation between machine posture and gravity center position**

The measuring objects were a 7 ton-class excavator-based grapple loader with two winches (HITACHI ZX75US + IWAFUJI TW-232B + IWAFUJI GS-65LJV) and a 12 ton-class excavator-based harvester (SUMITOMO SH135 + KESLA 25RHS). Prior to ground pressure distributions, we measured weight distributions of the machines in several postures to estimate the relation between machine posture and gravity center position. The weight distributions were measured by four load cells placed at the front and rear ends of contact areas of both crawler tracks. Along with the weight distribution, positions of boom-foot pin, boom-point pin, and arm-point pin were also measured using a total station to obtain angles of the boom and arm from horizon ( $\theta_1$  and  $\theta_2$ , respectively). In this way, we measured weight distributions and estimated the gravity center positions in 13 different postures. We chose the coordinate system where the origin is the boom-foot pin position, x-axis is the lengthwise direction of the machine, and y-axis is the crosswise direction (hereafter called “CS1”) to describe the gravity center position. Using the moment-balance formula, the x coordinate of the gravity center should be a linear equation of  $\sin\theta_1$ ,  $\cos\theta_1$ ,  $\sin\theta_2$ , and  $\cos\theta_2$ . We estimated the equation by multiple regression analysis for the 13 data sets.

### **2.2 Ground pressure distribution**

Ground pressure distributions of the machines were recorded by driving the machines on four soil pressure gauges (BEM-A-500KP; each of them are hereafter called SPG1, 2, 3, and 4) buried in ungraveled logging road. Measurements were conducted in the national forest in Numata, Gunma. The soil pressure gauges were buried at 3 cm deep at points where the center of each crawler track passes (SPG1 and 3 were for right crawler track and SPG2 and 4 were for the left crawler track), and their positions were recorded by the total station. The rectangular area defined by the four gauges was the “measuring area.” Prior to driving, the positions of the three pins were recorded by the total station to obtain  $\theta_1$  and  $\theta_2$ . Retaining the posture, the operator drove the machine slowly over the measuring area. While driving, the gauges recorded the soil pressure in 10 Hz. The 7 ton-class machine conducted six trial runs in each posture (run back and forward three times). By contrast, the 12 ton-class machine conducted only two trial runs in each

posture because the logging road surface became muddy when the 7 ton-class trial runs ended such that numerous runs were difficult.

Along with the soil pressure, the positions of a surveying prism attached to the machine were recorded by the total station in 10 Hz. Using the position data, we calculated the relative positions of the gauges to the machine at every moment when each soil pressure value was recorded. Subsequently, we converted the time-series ground pressure data into the lengthwise ground pressure distributions of the machine. Thus, we recorded the ground pressure distributions in five and three different postures for the 7 ton- and 12 ton-class machines, respectively. We chose a coordinate system where the origin is the front end of the contact area of the left crawler track, x-axis is the lengthwise direction (backward of the machine is plus), and y-axis is the crosswise direction of the machine (right side of the machine is plus). This system (or CS2) was used to describe the ground pressure distributions.

### 3. RESULTS AND DISCUSSIONS

#### 3.1 Relation between machine posture and gravity center position

The following equations were obtained from the multiple regression analysis for the 7 ton- and 12 ton-class machines, respectively.

$$x = 1/M (41958 \cos\theta_1 + 3506 \sin\theta_1 + 13271 \cos\theta_2 - 1419 \sin\theta_2 - 14180) \quad (1)$$

$$x = 1/M (121247 \cos\theta_1 - 9736 \sin\theta_1 + 47184 \cos\theta_2 - 56 \sin\theta_2 - 50749) \quad (2)$$

where  $x$  is the x coordinate value of gravity center position of the machine in CS1 (m),  $M$  is the total weight of the machine (N),  $\theta_1$  is the boom angle to horizon (rad), and  $\theta_2$  is the arm angle to horizon (rad). The total weights of the machines measured by the four load cells were 99743 and 160290 N. The determination coefficient of the equations was 0.99.

#### 3.2 Ground pressure distribution

##### 3.2.1 General features of ground pressure distributions

Figure 1 shows the lengthwise ground pressure distributions of the right crawler tracks of the machines in three different postures. In these figures, the blue and green lines show measured ground pressure distributions, gray lines show calculated distributions on the assumption that pressure is distributed linearly, and circles show the x coordinate of gravity center positions in CS2 calculated from Equations (1) and (2). The distributions were not uniform but concentrated to the positions of the track rollers, drive wheel, and idler wheel. Similar results were reported by Muro *et al.* (1998). Their measuring object was a crawler-type vehicle without a front attachment; therefore, the gravity center position and highest peak of ground pressure were fixed near the center of



the contact area. In our study, the distribution to the first track roller increased as the gravity center position moved forward.

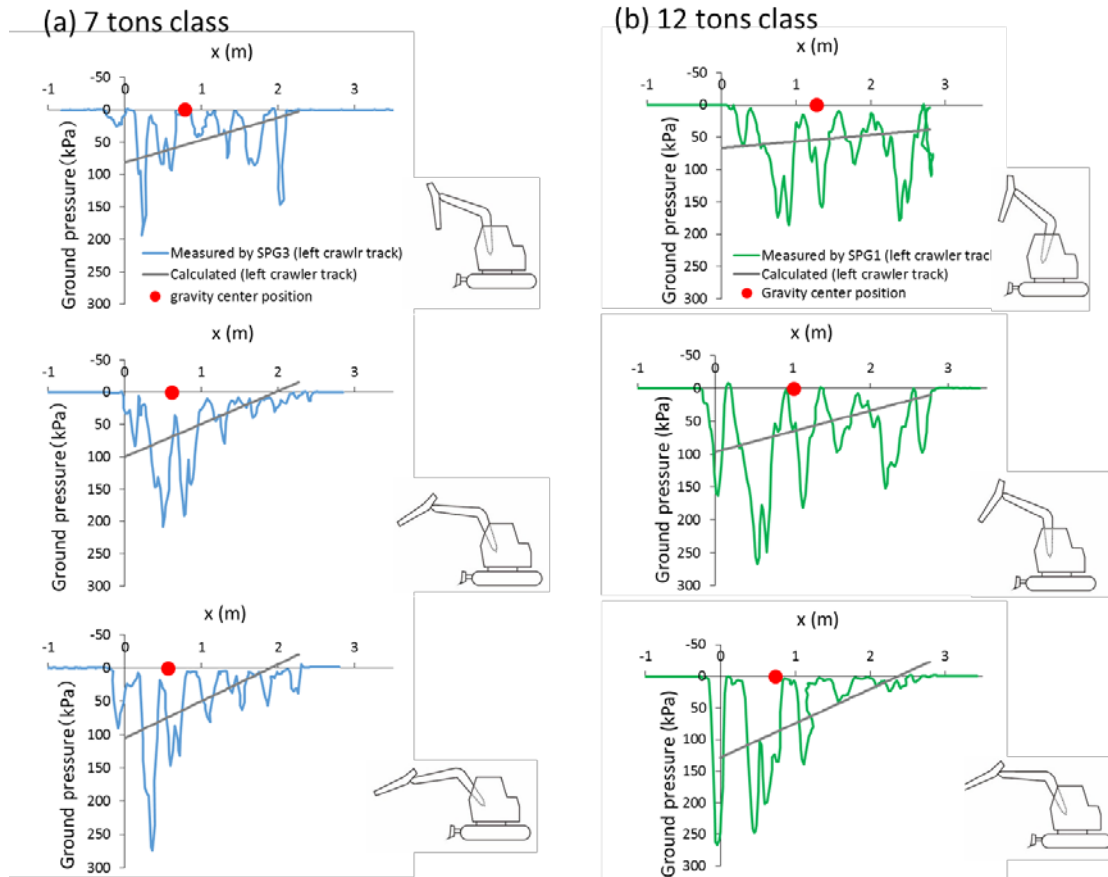

Figure 1. Ground pressure distribution in three different postures

### 3.2.3 Maximum ground pressure in relation to the gravity center position

Figure 2 shows the maximum pressure and gravity center positions in each trial run. As previously mentioned, six values were plotted in the same gravity center position for the 7 ton-class machine, whereas two values were plotted in the 12 ton-class machine. In Figure 2(b), the data recorded by SPG3 were excluded because of an issue with the gauge (unexplained fluctuations were found in the data).

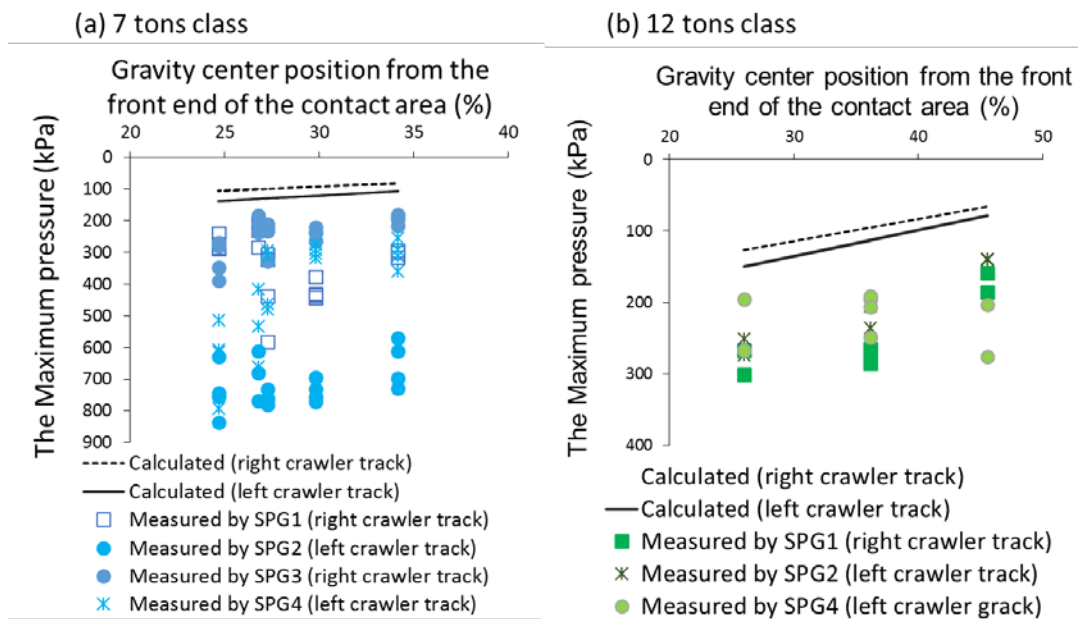

Figure 2. Maximum ground pressure and gravity center position

The peak pressure of the 7 ton-class machine was higher than that of the 12 ton-class machine because the former had a smaller contact area, resulting in narrow crawler tracks and few track rollers. As well as the contact area, tension of the crawler track could influence the degree of pressure concentration.

Assuming that the crawler track was rigid and ground pressure was distributed linearly, the maximum pressure increased in proportion to the gravity center position, as shown in the solid and dotted black lines in the figure. The maximum pressures measured by SPG2, 3, and 4 in the 7 ton-class machine and by SPG1 and 2 in the 12 ton-class machine showed an increasing trend as the gravity center moved forward. For the 12 ton-class machine, the relation between measured maximum pressure and the gravity center position was almost parallel to the theoretical line. However, for the 7 ton-class machine, the trends varied from one gauge to another. Theoretically, the data measured by SPG1 and SPG3 should be equivalent because both were passed by the right crawler track, but there were gaps between them in the 7 ton-class machine. The same observation was noted for SPG2 and SPG4. This phenomenon may be due to the rolling and pitching of the machines because the logging road surface was not completely flat nor smooth.

The maximum in all trials of 7 ton-class and 12 ton-class was 837 and 300 kPa, respectively. The lengthwise position of the gravity center was 25% and 26% from the front end of the contact area and working radius of 4.9 and 6.4 m, respectively. Although the reliability of the former is questionable because the capacity of the soil pressure gauge was 500 kPa, logging roads could be subjected 500 kPa or higher by a 7

ton-class excavator-based forest machine, which is widely used in Japanese forestry.

#### **4. CONCLUSIONS**

We attempted to clarify the real ground pressure distributions of 7 ton- and 12 ton-class excavator-based forest machines in relation to the gravity center position. The real ground pressure distribution was not uniform but concentrated to the track rollers, drive wheel, and idler wheel, leading to considerably higher maximum pressure than the mean ground pressure. The maximum pressure of the distributions increased as the gravity center position moved forward. The results suggest that logging roads could be subjected to more than 500 kPa by a 7 ton-class excavator-based forest machine, which is widely used in Japanese forestry.

#### **ACKNOWLEDGEMENT**

The authors thank Mr. Yoshihiro Kariya and Mr. Nobuyuki Izumida for helping our study.

#### **REFERENCES**

Muro, T., Yoshioka, N. and Miyoshi, M. (1998) "Effects of roller and tracked vehicle mounting a centrifugal oscillator on the vibro-compaction of a high lifted decomposed granite sandy soil." *Proc. JSCE.*, 588, 139-150 (in Japanese with English summary).







9784990672515

**ISBN 978-4-9906725-1-5**